

BIBUS

BIBUS SINDBY



Profler 8

Velkommen

BIBUS SINDBY A/S er et solidt og velkonsolideret import- og handelsfirma, der har industrien og opbyggere som de to største kundegrupper. I de over 100 år firmaet har eksisteret, er en videnbank bygget op omkring indkøb og udvikling af kvalitetsprodukter primært til industrien. Sund fornuft og kvalitet er nøgleordene for al handling i virksomheden. Vi har været i konstant udvikling siden starten og har skabt en virksomhed, der er rustet til de stigende udfordringer og muligheder i industriens utallige niches.

Adm. direktør Keld Hansen er i dag manden bag BIBUS SINDBY. I 2007 overtog BIBUS AG virksomheden efter den tidligere ejer og Sindby-familien, der siden 1918 har drevet firmaet over tre generationer. Virksomheden har løbende udviklet sig med kundeklientellet.

Energioptimering

BIBUS SINDBY A/S iværksatte i september 2022 en proces, hvor vi gennemgik vores el- og gasforbrug. Med en ny investering i belysning samt en simpel adfærdændring, lykkedes vi med at reducere vores elforbrug med over 40%. Vi offentliggør vores forbrug internt og på vores hjemmeside en gang i måneden for konstant at holde hinanden op på bedre forbrugsvaner. Vil du høre mere om vores tiltag, så er du altid velkommen til at kontakte os.

We care about nature

Hos BIBUS SINDBY A/S har vi taget et aktivt valg for at mindske tab af biodiversiteten. Helt konkret har vi etableret et stort udendørsområde med vandhul, insekthoteller, sandbade, tørvestabler og frugttræer til bestøvning. Du kan følge udviklingen her eller gøre som vores medarbejdere - gå en tur rundt på de naturlige stier, kig dig omkring eller hold en pause ved bålstedet og lad sanserne få en anderledes oplevelse i en travl hverdag. Vores "have" er et fælles projekt, og derfor er det naturligt, at vores jubilare udvælger det træ eller den busk, de ønsker at have stående i fremtiden. I dette forår (2023) planter vi de næste i rækken. Udadtil prøver vi at få vores leverandører til at tage aktivt stilling til, hvad lige netop de kan gøre. Alene kan vi ikke redde alverden - men sammen en god del. Vi vil altid gerne inspireres og udfordres, så har i nogen bud på, hvordan vi bliver endnu bedre så sig endelig til.

Vores vigtigste ressource

Det er vores medarbejdere! Vi ønsker at dyrke det hele menneske. Det gør vi ved at interessere os for hinanden. Vi ønsker, at vores medarbejdere har et sundt familieliv, et aktivt fritidsliv og et meningsfyldt arbejdsliv. Kort sagt: Døgnet har 24 timer - så en tredjedel med fuld fokus på firmaet bør og skal være nok. Så er der også energi til at løfte i fælles flok, når det indimellem kræves. Vi ønsker at tiltrække unge mennesker og vi ønsker, at alle skal have lige rettigheder for at få en uddannelse og karriere, uanset etnicitet, religion, handicaps eller køn. For tiden gøres dette ved at vi støtter unge kvindelige håndboldspilleres mulighed for at kombinere elitesport og uddannelse. Det kan du læse mere på vores hjemmeside under sponsorater.

Vores værdisæt med få ord

Hos BIBUS SINDBY A/S tager vi ordet ORDENTLIGHED meget alvorligt.

Vi ved at det er et ældre og lidt støvet ord, men det dækker over den måde, vi ser på verden.

- Vi ønsker kun at samarbejde med leverandører, der overholder gældende miljøregler
- Vi tager kraftigt afstand fra tvangs- og børnearbejde
- Vi aflægger jævnligt besøg hos vores leverandører, for at sikre og præge, at vi deler et fælles værdigrundlag
- Vi prioriterer vores værdier højere end kortsigtet profitjagt, da det på den lange bane har vist sig, at udmønte i bedre resultater

Du kan læse vores Code of Conduct for at få flere informationer om vores retningslinjer.

Vi finder en løsning

Som nævnt arbejder vores medarbejdere ofte tæt sammen med kunden for at finde den ideelle løsning.

Gennem deltagelse på messer over hele verden sikres det, at vi altid er opdateret på den nyeste viden og de nyeste produkter. På den måde opbygger vi et stort og globalt net af forbindelser til producenter.

Hvert år udvikles over 400 nye produkter i samarbejde med kunderne, enten som eksklusive produkter eller som nye lagervarer hos os. Dette aftales fra projekt til projekt og kommer an på, hvad der er mest fordelagtigt for begge parter.

Vi ser frem til vores samarbejde!

Med venlig hilsen
Keld Hansen

Indholdsfortegnelse Table of content

1.	Kantlister Edge trims	4
2.	Silikonekantlister Silicone edge trims	18
3.	POM-profiler POM-profiles	23
4.	Gummisnor Rubber cord	26
5.	Specialprofiler Special profiles	28
6.	Silikoneprofiler (skaffevarer) Silicone profiles (special order items)	38
7.	Co-ekstruderede plastprofiler Co-extruded plastic profiles	43
8.	U-profiler U-profiles	47
9.	P-profiler P-profiles	53
10.	Rudeprofiler Glazing sections	56
11.	Låsekiler Filler strips	60
12.	Svampegummi Sponge rubber	62
13.	Glasbånd Window seals	72
14.	Cellegummi Cellular rubber	74
15.	Fenderlister Fender lists	76
16.	Sico trim Sico trim	80
17.	Gummibuffer Rubber buffer	84
18.	Vibrationsdæmpere Vibration muffler	91
19.	Fendere Fenders	100
20.	Børste- og flocklister Brush sections	106
21.	Lydisolering Soundproofing	110
22.	Gummiplader fra Kina Rubber sheets from China	114
23.	Gummimåtter Rubber mats	124
24.	Gummistropper Rubber straps	132
25.	Bumpers Bumpers	136
26.	Poliall Poliall	138
27.	Oppustelige tætninger Inflatable seals	140
28.	Tilbehør Equipment	143
29.	Egenskaber Properties	146
30.	Varenummerindeks Item number index	148

BEMÆRK

Tegningerne i dette katalog er ikke målfaste. Alle mål er i mm, hvis ikke andet er opgivet. Visse profiler lagerføres ikke men hjemtages kun på bestilling og ud fra mængde. Afklippede profiler tages ikke retur.

NOTE

The drawings in this catalog are not dimensionally accurate. All dimensions are in mm unless otherwise stated. Some profiles are not kept in stock, but are only available on order and based on quantity. Cut profiles are not returnable.

Kantlister

Edge trims

Hjørner og kanter er ofte udsat for ekstra slitage og stød. Derfor kan det være en stor fordel at anvende kantlister produceret i gummi. Kantlister bruges i dørkanter, trucks, rundt om vinduer, til stole, motordele, kabinetter mm.

Vi har mange forskellige lister på lager, som hver især er specificeret i forhold til type, kvalitet, med og uden ballon osv. Hvis vi ikke har produktet på lager, kan vi også levere specialprofiler på bestilling. Vi er derfor stolte af at sige, at vi kan løse næsten alle typer opgaver.

Med det store udvalg følger naturligvis en stor viden, som vi gerne deler ud af, skulle du have brug for det. Vi kan hjælpe dig omkring dit valg og kan besvare spørgsmål om stort set alt vedrørende vores kantlister.

Corners and edges are often exposed to additional wear and tear and impact. Therefore, it can be a great advantage to use edge trims made of rubber. Edge trims are used in door edges, trucks, around windows, for chairs, engine parts, cabinets, etc.

We have a wide variety edge trims in stock, each specified in terms of type, quality, with and without balloon, etc. If we do not have the product in stock, we can supply special profiles on order. We are therefore proud to say that we can solve almost any type of task.

Naturally, with a large selection comes a wealth of knowledge that we are happy to share should you need it. We can help you with your choice and answer any questions you might have concerning edge trims in our range.

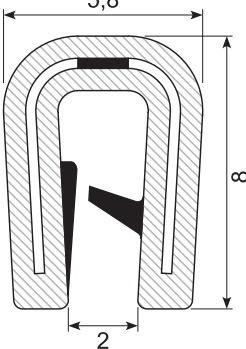
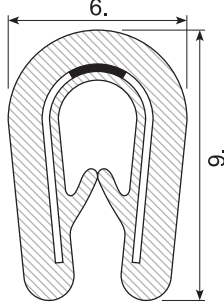
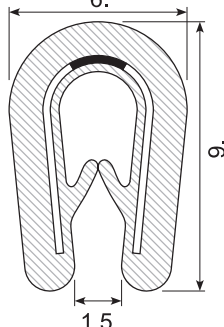
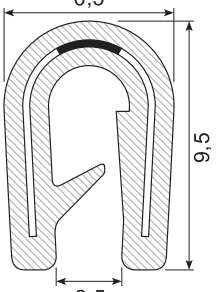
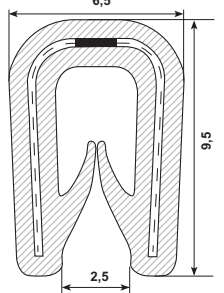
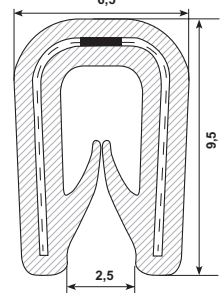
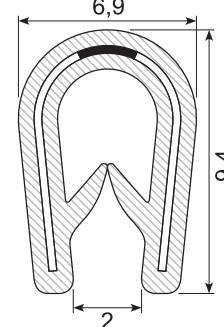
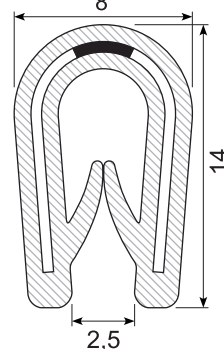
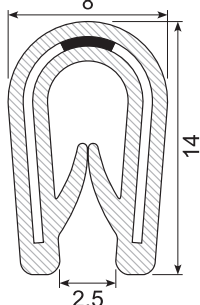
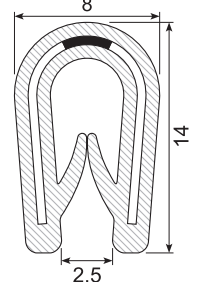
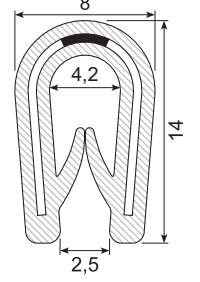
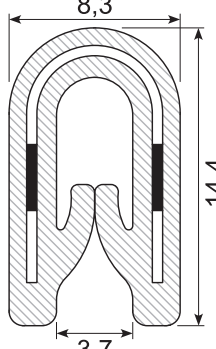
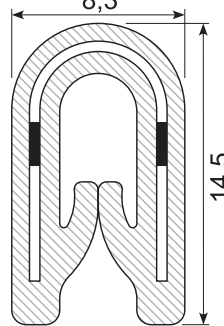
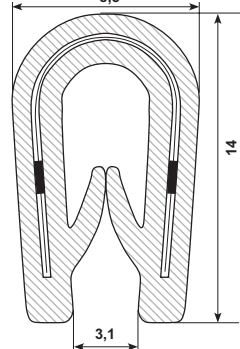
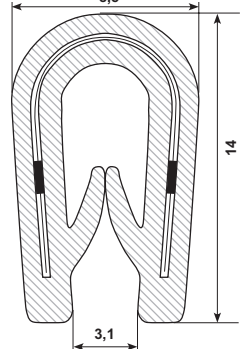
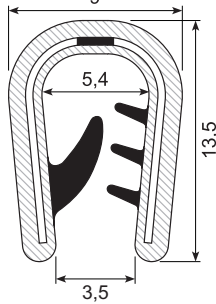

<p>33.306</p>  <p>Material: PVC, black + bi Grip range: 1 - 2 mm Hardness: SH 75 / 65 Insert: 15 x 0,3 mm steel</p>	<p>33.409F</p>  <p>Material: EPDM Grip range: 1 - 2 mm Hardness: SH 60 Insert: Steel Flammehæmmende <i>Flame retardant EN 45545</i></p>	<p>33.409 / 33.401G</p>  <p>Material: PVC, black / grey Grip range: 1 - 2 mm Hardness: SH 78 Insert: 16 x 0,3 mm steel 33.401G: Grey</p>	<p>33.307 / 33.307A</p>  <p>Material: PVC, black Grip range: 1 - 2 mm Hardness: SH 75 Insert: 17,5 x 0,3 mm steel 33.307A: På pappspole <i>On cardboard coil</i></p>
<p>33.410SS304</p>  <p>Material: PVC, black Grip range: 0.8 - 2.0 mm Hardness: SH 70 Insert: 17,5 x 0,4 mm Rustfrit stål SS 304 Stainless steel SS 304</p>	<p>33.410SS316</p>  <p>Material: PVC, black Grip range: 0.8 - 2 mm Hardness: SH 70 Insert: 17,5 x 0,4 mm Rustfrit stål SS 316 Stainless steel SS 316 Syrefast Acid-proof</p>	<p>33.410X / 33.410XG</p>  <p>Material: PVC, black / grey Grip range: 1 - 2 mm Hardness: SH 75 Insert: 17,5 x 0,3 mm steel 33.410XG: Grey</p>	<p>33.310X</p>  <p>Material: PVC, black Grip range: 1 - 3 mm Hardness: SH 75 Insert: 26 x 0,47 mm steel</p>
<p>33.310SS</p>  <p>Material: PVC, black Grip range: 1 - 2,5 mm Hardness: SH 70 - 75 Insert: 26 x 0,5 mm Rustfrit stål Stainless steel SS 304</p>	<p>33.310SS-316</p>  <p>Material: PVC, black Grip range: 1 - 2,5 mm Hardness: SH 70 - 75 Insert: 26 x 0,5 mm Rustfrit stål SS 316 Stainless steel SS 316 Syrefast Acid-proof</p>	<p>33.310SS-316EPDM</p>  <p>Material: EPDM, black Grip range: 1 - 2,5 mm Hardness: SH 80 Insert: 26 x 0,5 mm Flammehæmmende <i>Flame retardant</i> UL94V0 + Din 5510-2 Min. order: 20.000 m</p>	<p>33.422</p>  <p>Material: TPE, flexible Grip range: 1 - 2,5 mm Hardness: SH 82 Insert: 25 x 0,48 mm steel</p>
<p>33.309XM</p>  <p>Material: PVC, mokka brown Grip range: 1 - 2,5 mm Hardness: SH 78 Insert: Steel Specialtilbud <i>Special offer</i></p>	<p>33.310SS304</p>  <p>Material: PVC, black Grip range: 1.5 - 2.5 mm (1-3) Hardness: SH 70 Insert: 25.8 x 0,4 mm Rustfrit stål SS 304 Stainless steel SS 304</p>	<p>33.310SS316</p>  <p>Material: PVC, black Grip range: 1.5 - 2.5 mm (1-3) Hardness: SH 70 Insert: 25.8 x 0,4 mm Rustfrit stål SS 316 Stainless steel SS 316 Syrefast Acid-proof</p>	<p>33.418SS</p>  <p>Material: PVC, black + bi Grip range: 2 - 4 mm Hardness: SH 78 / 78 Insert: 26 x 0,5 mm Rustfrit stål 304 Stainless steel 304</p>

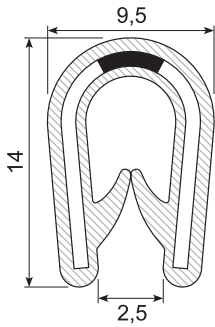
33.308 / 33.308A

Material: PVC, black
Grip range: 1 - 4 mm
Hardness: SH 75
Insert: 26 x 0,47 mm steel
33.308A: På pappspole
On cardboard coil

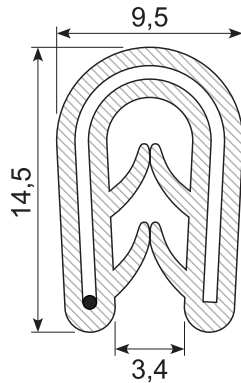
33.432

Material: EPDM
Grip range: 1 - 3 mm
Hardness: SH 65
Insert: 27 mm wire

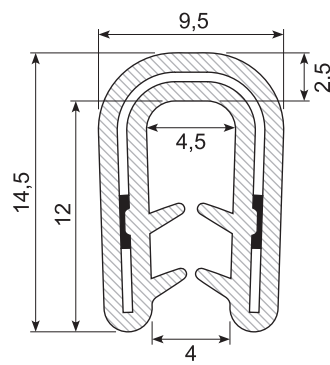
33.438

Material: EPDM
Grip range: 1,5 - 3,5 mm
Hardness: SH 65
Insert: 29 x 0,5 mm steel

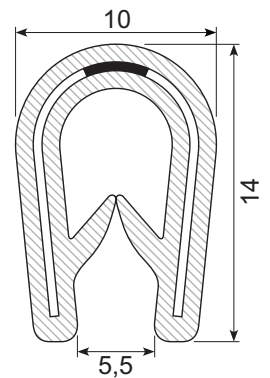
33.420X

Material: PVC, black
Grip range: 1 - 4 mm (3-5)
Hardness: SH 75
Insert: 27 x 0,47 mm steel

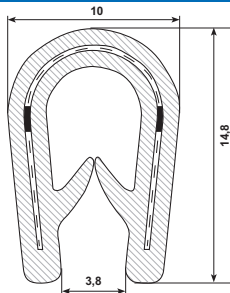
33.308SS304

Material: PVC, black
Grip range: 1,5 - 3 mm
Hardness: SH 70
Insert: 27 x 0,4 mm
Rustfrit stål SS 304
 Stainless steel SS 304

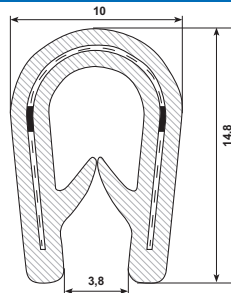
33.308SS316

Material: PVC, black
Grip range: 1,5 - 3 mm
Hardness: SH 70
Insert: 27 x 0,4 mm
Rustfrit stål SS 316
 Stainless steel SS 316
Syrefast Acid-proof

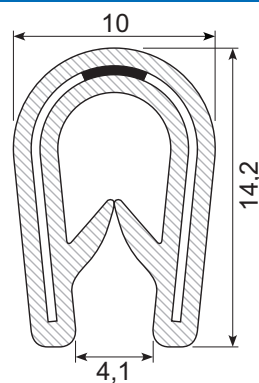
33.420H

Material: PVC, white
Grip range: 1 - 4 mm

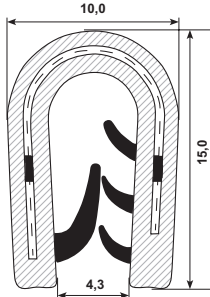
33.418SS304

Material: PVC, black
Grip range: 1,5 - 3 mm (2-4)
Hardness: SH 75/60
Insert: 27 x 0,4 mm
Rustfrit stål SS 304
 Stainless steel SS 304

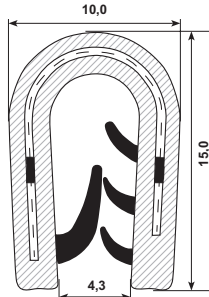
33.418SS316

Material: PVC, black
Grip range: 1,5 - 3 mm (2-4)
Hardness: SH 75/60
Insert: 27 x 0,4 mm
Rustfrit stål SS 316
 Stainless steel SS 316
Syrefast Acid-proof

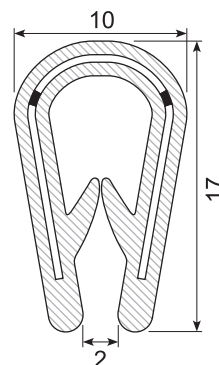
33.419

Material: PVC, black
Grip range: 1 - 4 mm
Hardness: SH 78
Insert: 31 x 0,5 mm steel

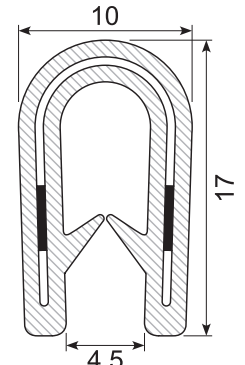
33.411

Material: PVC, grey
Grip range: 2,5 - 4 mm
Hardness: SH 78
Insert: 29 x 0,48 mm steel

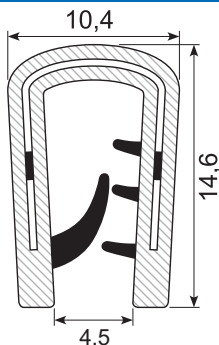
33.418X

Material: PVC, black + bi
Grip range: 2 - 4 mm
Hardness: SH 75 / 75
Insert: 26 x 0,5 mm steel
Hvide læber White lips

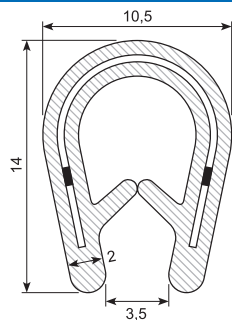
33.420FX

Material: EPDM
Grip range: 1 - 3 mm
Hardness: SH 60
Insert: 26 x 0,5 mm steel
Flammehæmmende
Flame retardant EN 45545

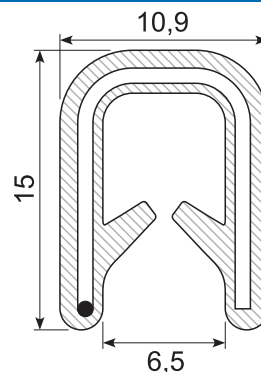
33.434

Material: EPDM
Grip range: 2 - 4 mm
Hardness: SH 65
Insert: 30 mm wire

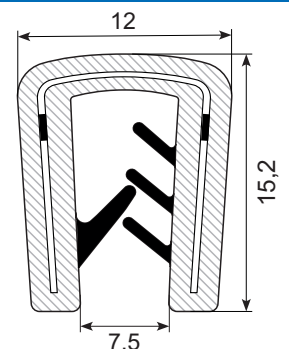
33.414

Material: PVC, black + bi
Grip range: 4 - 6 mm
Hardness: SH 75 / 60
Insert: 30 x 0,48 mm steel

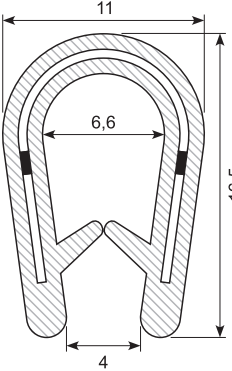
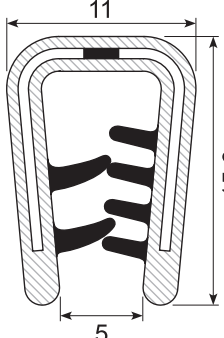
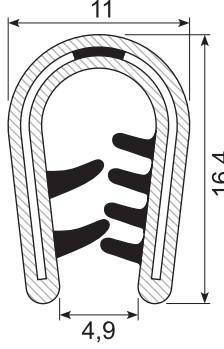
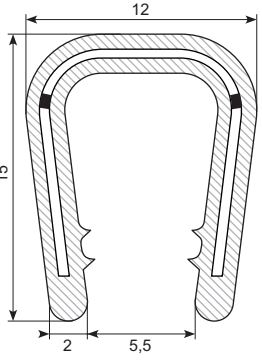
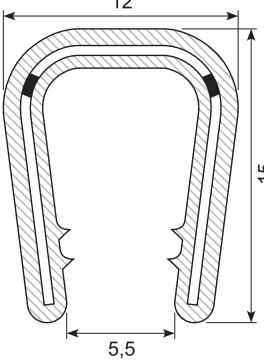
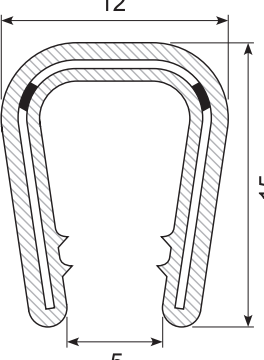
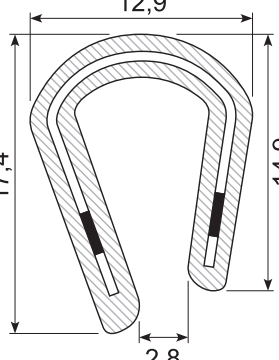
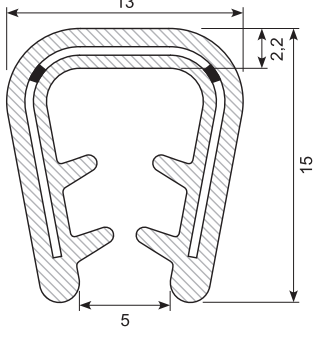
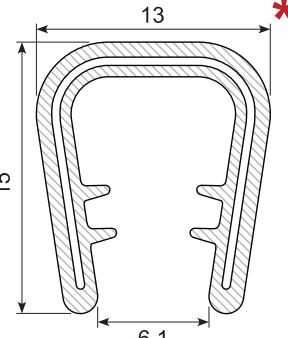
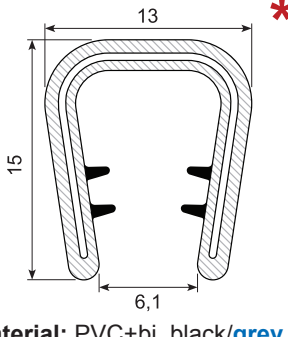
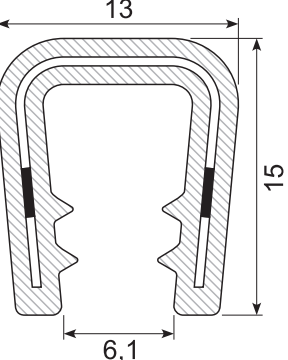
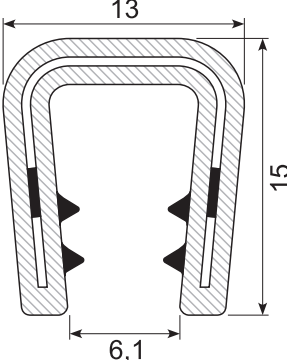
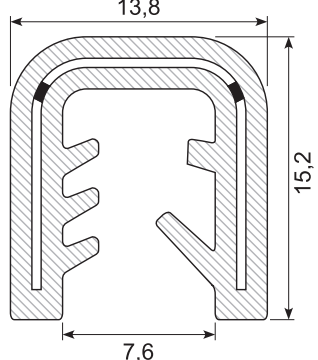
<p>33.419A</p>  <p>Material: PVC, black Grip range: 2 - 4 mm Hardness: SH 75 Insert: 30 x 0,5 mm steel</p>	<p>33.427X</p>  <p>Material: PVC, black + bi Grip range: 1,5 - 4,5 mm Hardness: SH 75 / 75 Insert: 30 x 0,47 mm steel Gule læber <i>Yellow lips</i></p>	<p>33.094X</p>  <p>Material: PVC, black + bi Grip range: 1 - 4 mm Hardness: SH 75 / 75 Insert: 30 x 0,47 mm steel Gule læber <i>Yellow lips</i></p>	<p>33.1153</p>  <p>Material: PVC, black Grip range: 6 - 8 mm Hardness: SH 78 Insert: 31 x 0,5 mm steel</p>
<p>33.1153A</p>  <p>Material: PVC, black Grip range: 6 - 8 mm Hardness: SH 78 Insert: 32 x 0,47 mm steel</p>	<p>33.1153GA</p>  <p>Material: PVC, grey Grip range: 6 - 8 mm Hardness: SH 78 Insert: 32 mm steel</p>	<p>33.415</p>  <p>Material: PVC, black Grip range: 5 - 7 mm Hardness: SH 78 Insert: 29 x 0,48 mm steel</p>	<p>33.435X</p>  <p>Material: EPDM Grip range: 5 - 8 mm Hardness: SH 70 Insert: 31 x 0,5 mm steel</p>
<p>33.426XA</p>  <p>Material: PVC, black Hardness: SH 78 Grip range: 4,5 - 7 mm Insert: 32 mm Min. order: 1.000 m</p>			
<p>33.426A / 33.426GA</p>  <p>Material: PVC+bi, black/grey Hardness: SH 78 / 65 Grip range: 4,5 - 7 mm Insert: 32 mm 33.426GA: Grey Min. order: 1.000 m</p>	<p>33.426X</p>  <p>Material: PVC, black Grip range: 4,5 - 7 mm Hardness: SH 75 Insert: 30 x 0,8 mm steel</p>	<p>33.426</p>  <p>Material: PVC, black + bi Grip range: 4,5 - 7 mm Hardness: SH 78 / 65 Insert: 29 x 0,48 mm steel</p>	<p>33.433</p>  <p>Material: EPDM Grip range: 4 - 6 mm Hardness: SH 70 Insert: 33 x 0,47 mm steel</p>

* Skaffevare Special order item

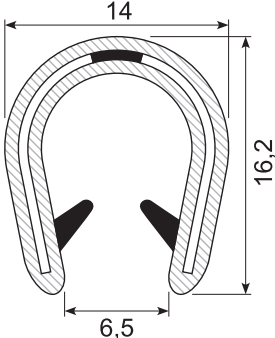
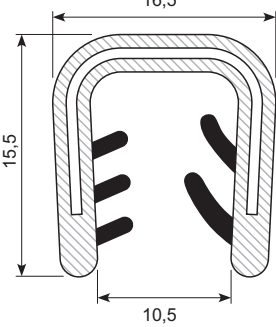
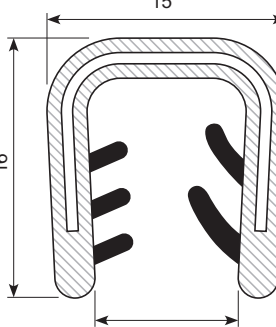
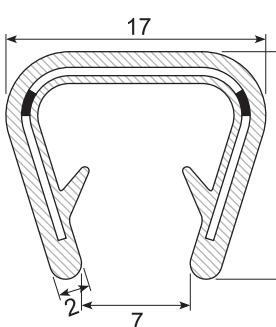
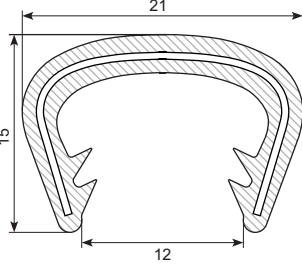
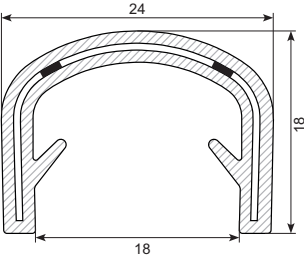
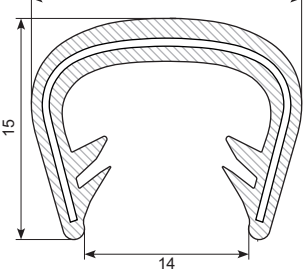
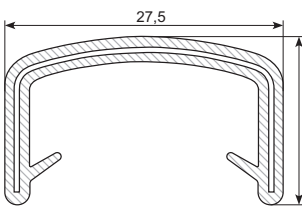
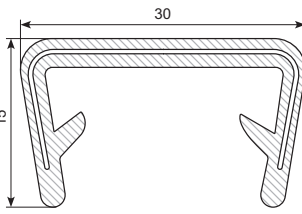
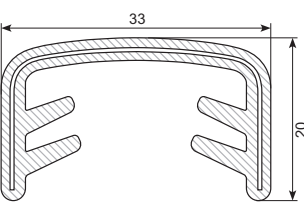
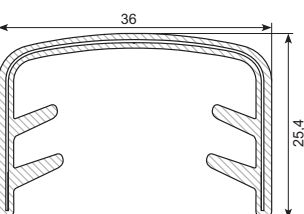
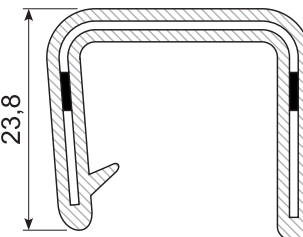
<p>33.1154</p>  <p>Material: PVC, black Grip range: 6 - 8 mm Hardness: SH 75 / 75 Insert: 30 x 0,47 mm steel Hvide læber <i>White lips</i></p>	<p>33.430</p>  <p>Material: PVC, black + bi Grip range: 10 - 12 mm Hardness: SH 75 / 60 Insert: 35 x 0,48 steel</p>	<p>33.430A</p>  <p>Material: PVC Grip range: 8 - 10 mm Hardness: SH 75 / 60 Insert: 35 x 0,48 steel</p>	<p>33.428 / 33.428G</p>  <p>Material: PVC+bi, black/grey Grip range: 10 - 12 mm Hardness: SH 78 Insert: 36 x 0,5 mm steel 33.428G: Grey</p>
<p>33.1157</p>  <p>Material: PVC, black Grip range: 12 - 14 mm Hardness: SH 75 Min. order: 100 m</p>	<p>33.1158A</p>  <p>Material: PVC, black Grip range: 13 - 15 mm Hardness: SH 70 Insert: 45 x 0,48 mm steel Min. order: 500 m</p>	<p>33.1159</p>  <p>Material: PVC, black Grip range: 14 - 16 mm Hardness: SH 75 Min. order: 100 m</p>	<p>33.1160</p>  <p>Material: PVC, black Grip range: 17 - 19 mm Hardness: SH 75 Min. order: 100 m</p>
<p>33.1161</p>  <p>Material: PVC, black Grip range: 20 - 23 mm Hardness: SH 75 Min. order: 100 m</p>	<p>33.1162</p>  <p>Material: PVC, black Grip range: 25 - 27 mm Hardness: SH 75 Min. order: 100 m</p>	<p>33.1163</p>  <p>Material: PVC, black Grip range: 28 - 32 mm Hardness: SH 75 Min. order: 100 m</p>	<p>33.1155</p>  <p>Material: PVC, black Grip range: 15 - 16 mm Hardness: SH 85 Insert: Steel</p>

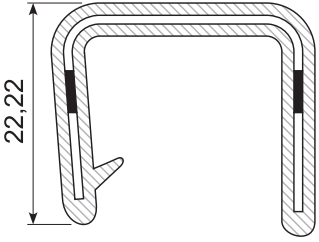
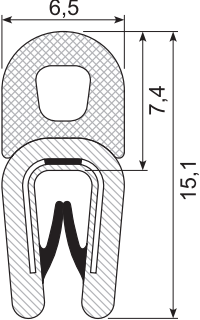
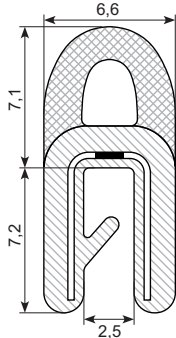
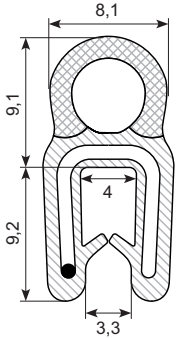
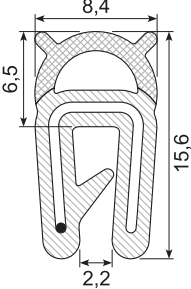
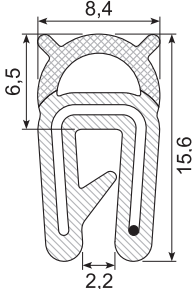
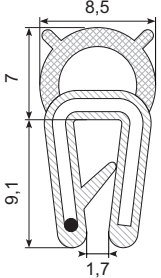
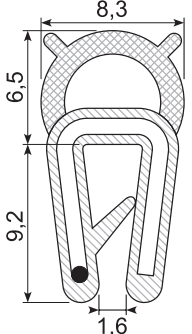
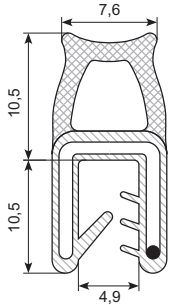
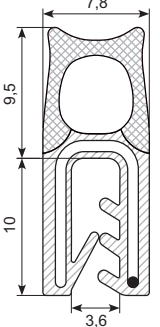
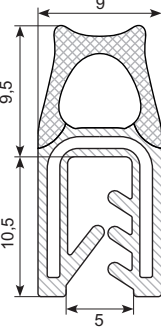
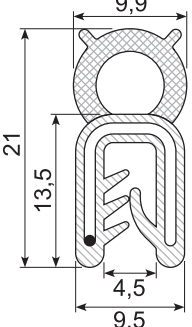
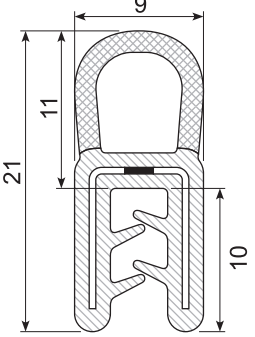
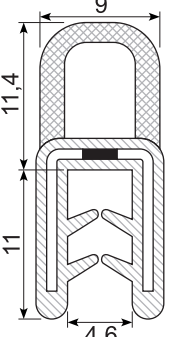
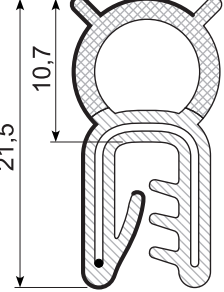
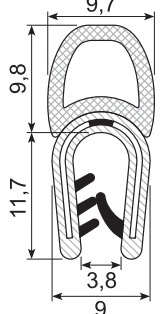
<p>33.1156</p>  <p>Material: PVC, black Grip range: 18 - 19 mm Hardness: SH 85 Insert: Steel</p>	<p>33.354</p>  <p>Material: PVC, black+bi / sponge rubber Grip range: 1 - 2 mm Hardness: SH 78 / 57 Density: 0,55 Insert: 16 x 0,3 mm steel</p>	<p>33.354A</p>  <p>Material: EPDM co-ex Grip range: 1,5 - 2 mm Hardness: SH 70 Density: 0,55 Insert: 17,5 mm steel</p>	<p>33.354B</p>  <p>Material: EPDM co-ex Grip range: 1,5 - 2,5 mm Hardness: SH 70 Density: 0,55 Insert: 22 mm steel</p>
<p>33.468F</p>  <p>Material: EPDM co-ex Grip range: 1 - 2 mm Hardness: SH 60 Density: 0,8 Insert: 22 x 0,75 mm wire Flammehæmmende Flame retardant EN 45545</p>	<p>33.468X</p>  <p>Material: EPDM co-ex Grip range: 1 - 2 mm Hardness: SH 60 Density: 0,55 Insert: 22 x 0,75 mm wire Discontinued when sold Alternative e.g. 33.468B</p>	<p>33.468FX</p>  <p>Material: EPDM co-ex Grip range: 1 - 2 mm Hardness: SH 75 Density: 0,55 Insert: 22 x 0,74 mm wire Flammehæmmende Flame retardant UL94-VO Min. order: 3.000 m</p>	<p>33.468B</p>  <p>Material: EPDM co-ex Grip range: 1 - 2 mm Hardness: SH 70 Density: 0,55 Insert: 22 mm wire</p>
<p>33.358A *</p>  <p>Material: EPDM co-ex Grip range: 2 - 4 mm Hardness: SH 70 Density: 0,55 Insert: 27 mm wire Min. order: 3.000 m</p>	<p>33.358D</p>  <p>Material: EPDM co-ex Grip range: 1,5 - 2,5 mm Hardness: SH 70 Density: 0,55 Insert: 25 mm wire</p>	<p>33.358E</p>  <p>Material: EPDM co-ex Grip range: 2 - 4 mm Hardness: SH 70 Density: 0,55 Insert: 27 mm wire</p>	<p>33.021</p>  <p>Material: EPDM co-ex Grip range: 0,8 - 2 mm Hardness: SH 70 Density: 0,55 Insert: 25 mm wire</p>
<p>33.358X</p>  <p>Material: EPDM co-ex Grip range: 1 - 2,5 mm Hardness: SH 70 Density: 0,55 Insert: 26 x 0,5 mm unbroken</p>	<p>33.358B</p>  <p>Material: EPDM co-ex Grip range: 1 - 3 mm Hardness: SH 70 Density: 0,55 Insert: 27 mm</p>	<p>33.371E EMV - EMC - EMI *</p>  <p>Material: EPDM co-ex Grip range: 1 - 3 mm Hardness: SH 70 Density: 0,55 Insert: Wire Elektrisk ledende Electrically conductive</p>	<p>33.469X</p>  <p>Material: PVC, black +bi / sponge rubber Grip range: 1,5 - 3,5 mm Hardness: SH 75 / 63 Density: 0,6 - 0,85 Insert: 26 x 0,47 mm steel</p>

* Skaffevare Special order item

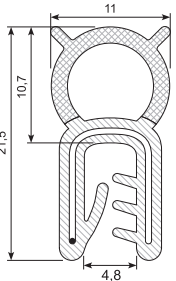
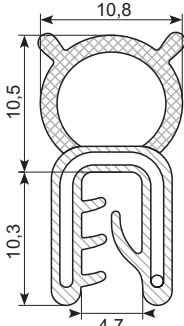
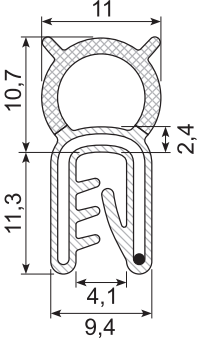
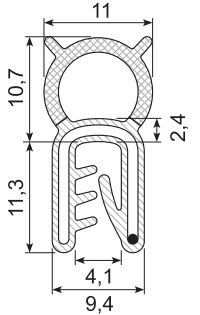
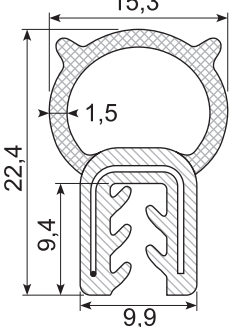
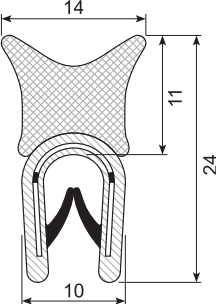
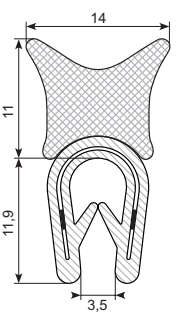
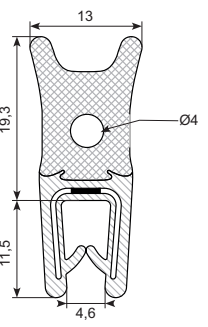
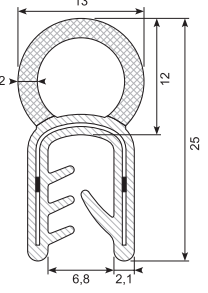
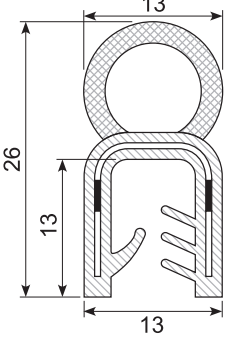
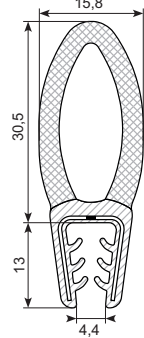
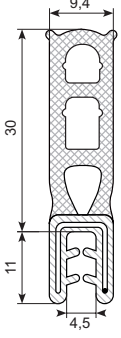
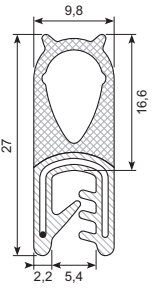
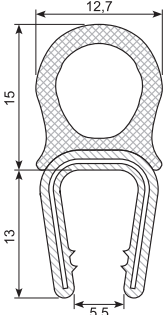
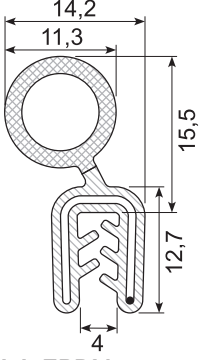
<p>33.371FX</p>  <p>Material: EPDM co-ex Grip range: 1 - 3 mm Hardness: SH 60 Density: 0,8 Insert: 26 x 0,75 mm wire Flammehæmmende Flame retardant EN 45545</p>	<p>33.371</p>  <p>Material: EPDM co-ex Grip range: 1 - 3 Hardness: SH 70 Density: 0,55 Insert: 25 mm wire</p>	<p>33.371X</p>  <p>Material: EPDM co-ex Grip range: 1 - 3,5 mm (1-3) Hardness: SH 70 Density: 0,55 Insert: 27 mm wire</p>	<p>33.370NBR</p>  <p>Material: NBR co-ex Grip range: 1 - 3 mm Hardness: SH 70 Density: 0,55 Insert: Wire Oliebestandig Oil resistant</p>
<p>33.369</p>  <p>Material: EPDM co-ex Grip range: 2 - 4 mm Hardness: SH 65 Density: 0,6 Insert: Wire</p>	<p>33.481</p>  <p>Material: PVC, black + bi / sponge rubber Grip range: 1 - 4 mm Hardness: SH 57 / 78 Density: 0,55 Insert: Steel</p>	<p>33.481A</p>  <p>Material: PVC, black Grip range: 1 - 3 mm Hardness: SH 75 Density: 0,55 Insert: 26 mm steel</p>	<p>33.481B</p>  <p>Material: EPDM co-ex Grip range: 1,5 - 3,5 mm Hardness: SH 70 Density: 0,55 Insert: 27 mm steel</p>
<p>33.353NBR</p>  <p>Material: NBR co-ex Grip range: 3 - 4 mm Hardness: SH 70 Density: 0,55 Insert: 31 x 0,5 mm Oliebestandig Oil resistant Min. order: 3.000 m</p>	<p>33.353</p>  <p>Material: EPDM co-ex Grip range: 3 - 5 mm Hardness: SH 65 Density: 0,6 Insert: 32 mm steel</p>	<p>33.351</p>  <p>Material: EPDM co-ex Grip range: 2 - 4 mm Hardness: SH 70 Density: 0,65 Insert: 33 mm steel</p>	<p>33.351A</p>  <p>Material: EPDM co-ex Grip range: 1,5 - 3,5 mm Hardness: SH 70 Density: 0,55 Insert: 27 mm wire</p>
<p>33.362FX</p>  <p>Material: EPDM co-ex Grip range: 1 - 3,5 mm Hardness: SH 60 Density: 0,8 Insert: 26 x 0,75 mm wire Flammehæmmende Flame retardant EN 45545</p>	<p>33.357X</p>  <p>Material: PVC, black / sponge rubber Grip range: 5 - 7 mm Hardness: SH 78 Density: 0,6 Insert: 31 x 0,5 mm</p>	<p>33.359X</p>  <p>Material: EPDM co-ex Grip range: 1,5 - 4 mm Hardness: SH 70 Density: 0,6 - 0,85 Insert: 25 wire</p>	

* Skaffevare Special order item

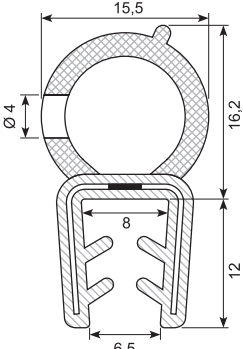
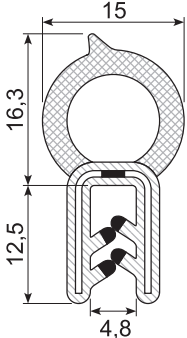
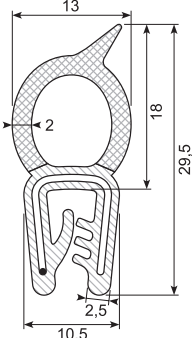
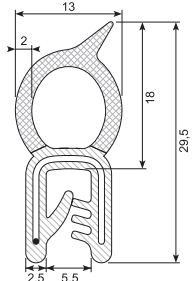
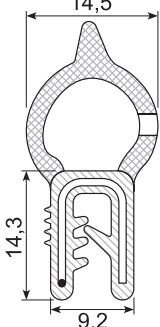
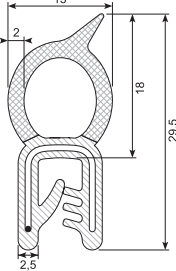
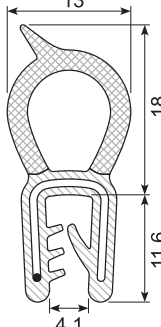
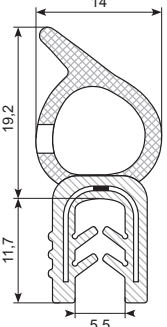
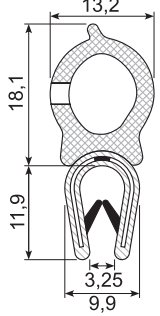
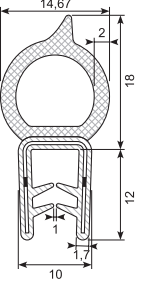
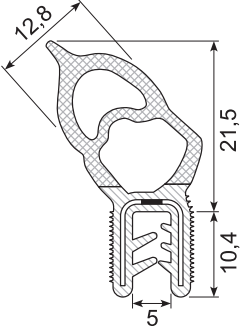
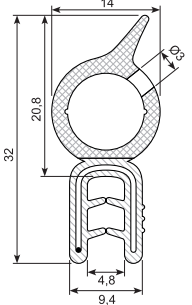
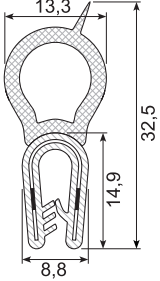
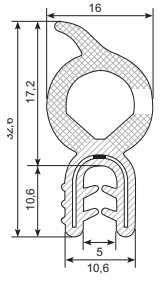
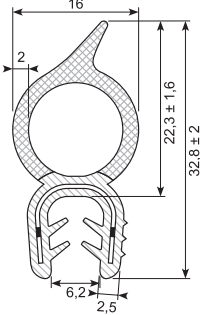
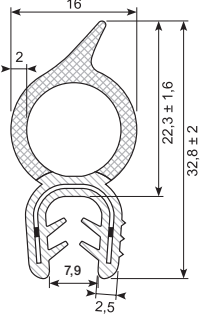
<p>33.353X</p>  <p>Material: EPDM co-ex Grip range: 4 - 6 mm Hardness: SH 65 Density: 0,6 Insert: 33 mm steel</p>	<p>33.376</p>  <p>Material: EPDM co-ex Grip range: 1 - 3,5 mm Hardness: SH 70 Density: 0,75 Insert: 27 mm steel</p>	<p>33.360</p>  <p>Material: EPDM co-ex Grip range: 1 - 2,5 mm Hardness: SH 60 Density: 0,6 Insert: 27 x 0,75 mm wire</p>	<p>33.360NBR *</p>  <p>Material: NBR co-ex Grip range: 1 - 3 mm Hardness: SH 70 Density: 0,55 Insert: 27 x 0,75 wire Oliebestandig Oil resistant Min. order: 4.000 m</p>
<p>33.377</p>  <p>Material: EPDM co-ex Grip range: 1 - 3,5 mm Hardness: SH 70 Density: 0,75 Insert: 27 mm wire</p>	<p>33.360F *</p>  <p>Material: EPDM co-ex Grip range: 2 - 4 mm Hardness: SH 65 Density: 0,6 Insert: 27 x 0,76 mm wire Flammehæmmende Flame retardant NNF 16101 (Certificate valid only 2016) Min. order: 3.000 m</p>	<p>33.360X</p>  <p>Material: EPDM co-ex Grip range: 1 - 2,5 mm (1-3) Hardness: SH 70 Density: 0,6 Insert: 27 x 0,74 mm wire</p>	<p>33.362X</p>  <p>Material: EPDM co-ex Grip range: 2 - 3,5 mm (2-4) Hardness: SH 70 Density: 0,60 Insert: 26 x 0,47 mm steel</p>
<p>33.365X</p>  <p>Material: PVC, black + bi / sponge rubber Grip range: 1 - 4 mm Hardness: SH 75 / 63 Density: 0,6 - 0,85 Insert: 26 x 0,47 mm steel</p>	<p>33.362F *</p>  <p>Material: EPDM co-ex Grip range: 2 - 4 mm Hardness: SH 65 Density: 0,6 Insert: 29 x 0,5 mm steel Flammehæmmende Flame retardant NNF 16101 (Certificate valid only 2016) Min. order: 1.000 m</p>	<p>33.374</p>  <p>Material: EPDM co-ex Grip range: 1,5 - 4 mm Hardness: SH 70 Density: 0,55 Insert: 27 x 0,47 mm steel</p>	<p>33.362D *</p>  <p>Material: EPDM co-ex Grip range: 2 - 4 mm Hardness: SH 65 Density: 0,6 Insert: 27 x 0,75 mm wire Min. order: 510 m</p>
<p>33.360R</p>  <p>Material: PVC, black / sponge rubber Grip range: 1 - 2,5 mm Hardness: SH 77 Density: 0,65 - 0,75 Insert: 26 x 0,5 mm Rustfri stål Stainless steel 304</p>	<p>33.362H</p>  <p>Material: EPDM co-ex Grip range: 1,5 - 3,0 mm Hardness: SH 75 Density: 0,65 Insert: 26 x 0,47 mm Rustfri stål</p>	<p>33.362E *</p>  <p>Material: EPDM co-ex Grip range: 3 - 5 mm Hardness: SH 65 Density: 0,65 Insert: 26 x 0,5 mm steel Min. order: 1.500 m</p>	<p>33.362I *</p>  <p>Material: EPDM co-ex Grip range: 5-6 mm Hardness: SH 65 Density: 0,65 Insert: 26 x 0,5 mm steel Min. order: 1.000 m</p>

* Skaffevare Special order item

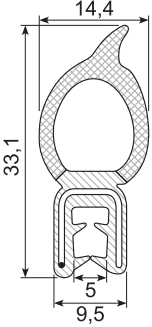
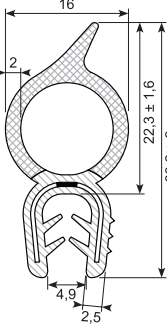
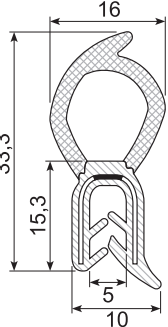
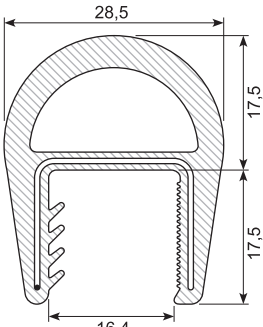
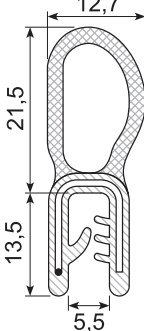
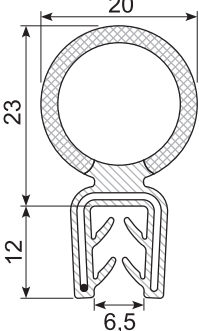
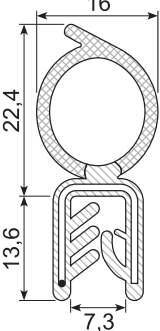
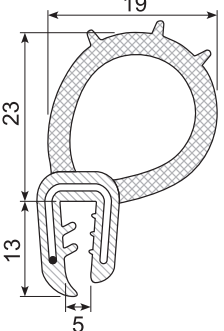
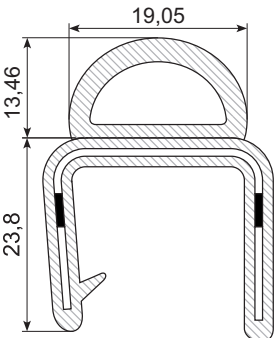
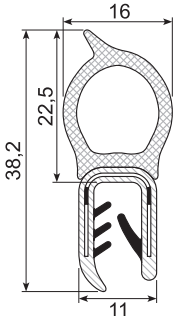
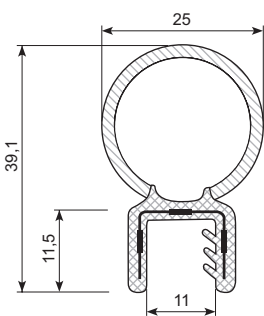
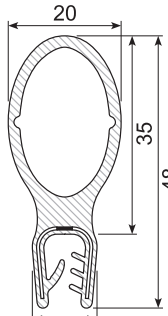
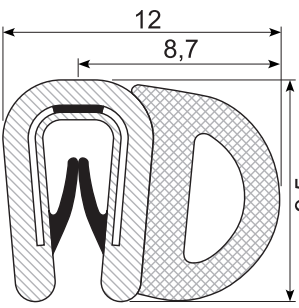
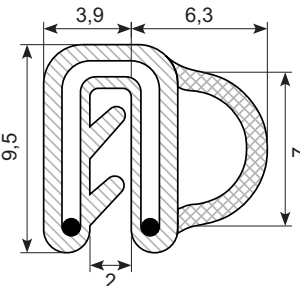
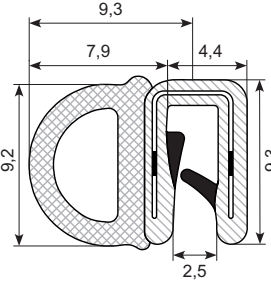
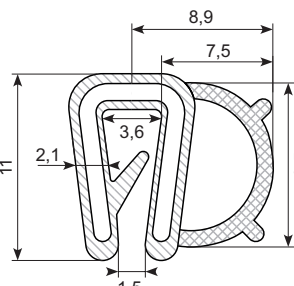
<p>33.362</p>  <p>Material: EPDM co-ex Grip range: 1 - 3,5 mm Hardness: SH 70 Density: 0,6 Insert: 26 x 0,76 mm wire <i>Discontinued when sold</i></p>	<p>33.362C *</p>  <p>Material: EPDM co-ex Grip range: 1,5 - 3 mm Hardness: SH 65 Density: 0,65 Insert: 26 x 0,5 mm steel Min. order: 1.500 m</p>	<p>33.025</p>  <p>Material: EPDM co-ex Grip range: 1,5 - 3,5 mm Hardness: SH 70 Density: 0,55 Insert: 27 x 0,47 mm steel</p>	<p>33.367 *</p>  <p>Material: EPDM, solid balloon Grip range: 16 mm Hardness: SH 60 Insert: 52 x 0,76 mm wire Min. order: 3.030 m</p>
<p>33.380</p>  <p>Material: EPDM co-ex Grip range: 2 - 4 mm Hardness: SH 70 Density: 0,55 Insert: 29 mm wire</p>	<p>33.379</p>  <p>Material: EPDM co-ex Grip range: 2,5 - 5 mm Hardness: SH 70 Density: 0,55 Insert: 33 mm wire</p>	<p>33.378</p>  <p>Material: EPDM co-ex Grip range: 1,5 - 5 mm Hardness: SH 70 Density: 0,55 Insert: 33 mm wire</p>	<p>33.375</p>  <p>Material: EPDM co-ex Grip range: 4 - 5 mm Hardness: SH 70 Density: 0,6 - 0,85 Insert: 27 mm wire</p>
<p>33.367X</p>  <p>Material: PVC/sponge rubber, black Grip range: 15 - 16 mm Hardness: SH 85 Insert: Steel</p>	<p>33.463</p>  <p>Material: PVC, black + bi / sponge rubber Grip range: 4 - 6 mm Hardness: SH 78 / 57 Density: 0,55 Insert: 31 x 0,5 mm steel</p>	<p>33.463A *</p>  <p>Material: EPDM co-ex Grip range: 9 - 10,5 mm Hardness: SH X Density: X Insert: Wire</p>	<p>33.355B</p>  <p>Material: EPDM, solid balloon Grip range: 3 - 5 mm Hardness: SH 60 Insert: 31 x 0,5 mm steel, Unbroken</p>
<p>33.408X</p>  <p>Material: PVC, black + bi / sponge rubber Grip range: 1 - 2 mm Hardness: SH 78 / 57 Density: 0,55 Insert: 16 x 0,3 mm steel</p>	<p>33.408A</p>  <p>Material: EPDM co-ex Grip range: 1 - 1,5 mm Hardness: SH 70 Density: 0,55 Insert: 18 mm wire</p>	<p>33.408B</p>  <p>Material: PVC, black + bi Grip range: 1 - 2 mm Hardness: SH 75 / 65 Density: 0,55 Insert: 17,5 mm steel Transparente læber Transparent lips</p>	<p>33.407A</p>  <p>Material: EPDM co-ex Grip range: 1 - 2,5 mm Hardness: SH 70 Density: 0,55 Insert: 22 x 0,75 mm wire</p>

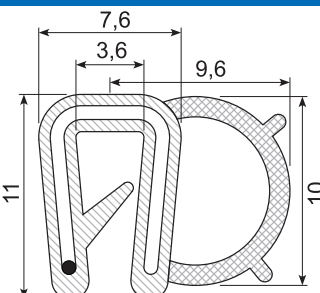
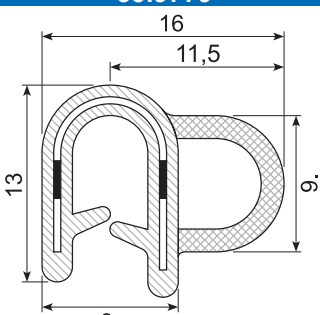
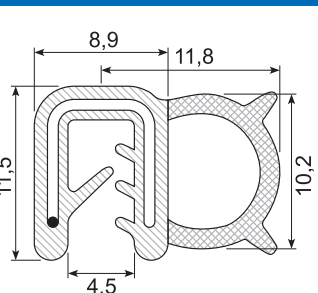
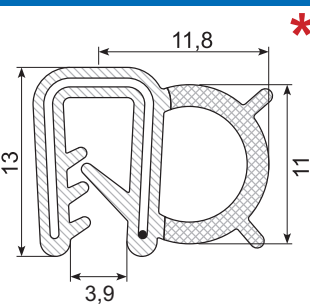
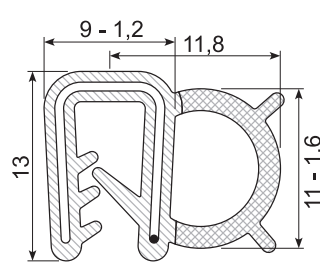
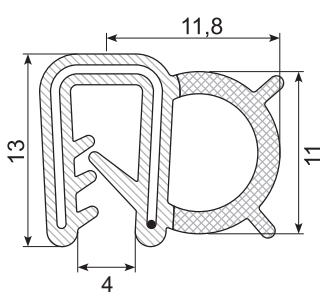
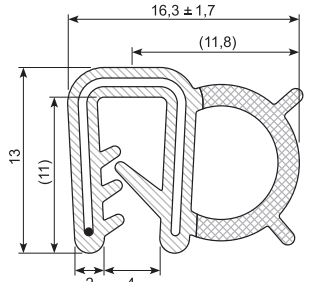
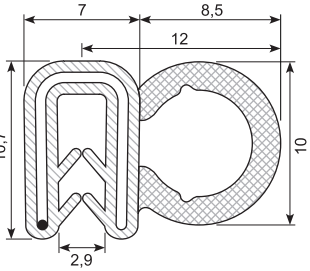
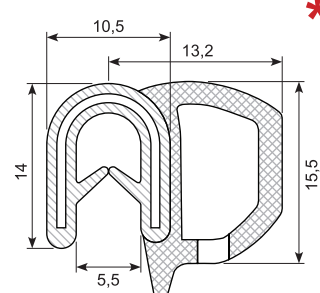
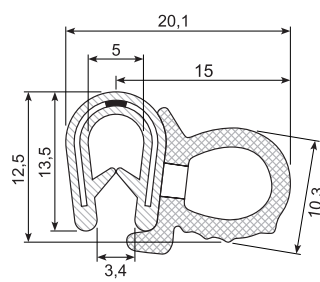
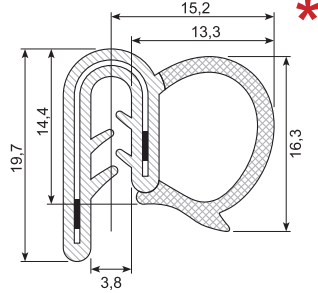
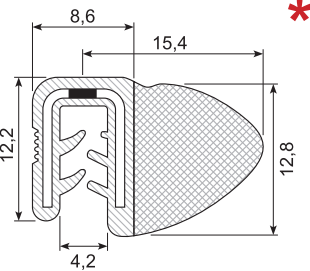
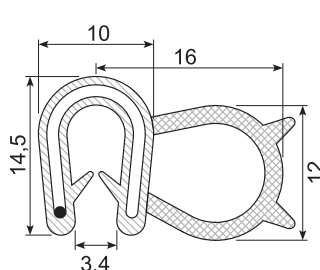
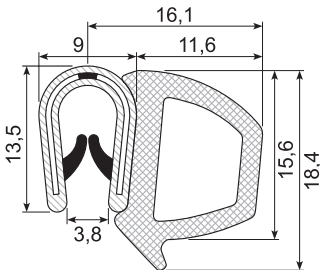
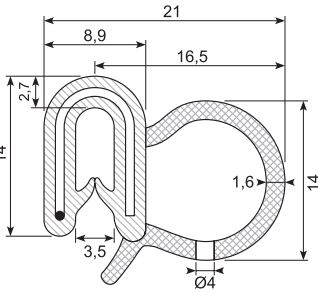
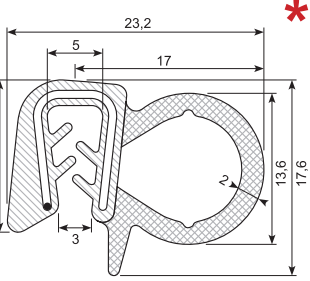
<p>33.403F</p>  <p>Material: EPDM co-ex Grip range: 1 - 2 mm Hardness: SH 60 Density: 0,8 Insert: 22 x 0,75 mm wire Flammehæmmende Flame retardant EN 45545</p>	<p>33.9779</p>  <p>Material: EPDM co-ex Grip range: 1,5 - 3 mm (1-3) Hardness: SH 70 Density: 0,65 Insert: 25 x 0,5 mm steel</p>	<p>33.395X</p>  <p>Material: EPDM co-ex Grip range: 1 - 3 mm Hardness: SH 70 Density: 0,55 Insert: Wire</p>	<p>33.395XA *</p>  <p>Material: EPDM co-ex Grip range: 1 - 3 mm Hardness: SH 70 Density: 0,55 Insert: Wire</p>
<p>33.398</p>  <p>Material: NBR co-ex Grip range: 2 mm Hardness: SH 60 Density: 0,55 Insert: 27 x 0,76 mm wire Oliebestandig Oil resistant</p>	<p>33.398X</p>  <p>Material: NBR co-ex Grip range: 1 - 3 mm Hardness: SH 70 Density: 0,55 Oliebestandig Oil resistant Min. order: 2.500 m</p>	<p>33.395F</p>  <p>Material: EPDM co-ex Grip range: 1 - 3 mm Hardness: SH 60 Density: 0,8 Insert: 26 x 0,75 mm wire Flammehæmmende Flame retardant EN 45545</p>	<p>33.381</p>  <p>Material: EPDM co-ex Grip range: 1 - 2,5 mm Hardness: SH 70 Density: 0,55 Insert: Wire</p>
<p>33.444A *</p>  <p>Material: EPDM co-ex Grip range: 1,5 - 4 mm Hardness: SH 70 Density: 0,55 Insert: Wire Min. order: 1.000 m</p>	<p>33.372X</p>  <p>Material: PVC, black / sponge rubber Grip range: 1 - 3,5 mm Hardness: SH 75 / 75 Density: 0,6 - 0,85 Insert: 22 x 0,47 mm steel</p>	<p>33.506 *</p>  <p>Material: EPDM co-ex Grip range: 1 - 2,5 mm Hardness: SH 70 Density: 0,6 Insert: 30 x 0,47 mm steel Min. order: 4.000 m</p>	<p>33.480 *</p>  <p>Material: EPDM co-ex Grip range: 1 - 3,5 mm Hardness: SH 70 Density: 0,55 Insert: Steel 33.480-1435: Fixed length: 1.435 mm</p>
<p>33.396</p>  <p>Material: EPDM co-ex Grip range: 1 - 3 mm Hardness: SH 70 Density: 0,6 - 0,85 Insert: 27 mm wire</p>	<p>33.444X</p>  <p>Material: PVC, black + bi / sponge rubber Grip range: 1 - 3,5 mm Hardness: SH75 / 75 Density: 0,6-0,86 Insert: 26 x 0,47 mm steel Røde læber Red lips</p>	<p>33.319</p>  <p>Material: EPDM co-ex Grip range: 1 - 3 mm Hardness: SH 70 Density: 0,6 - 0,85 Insert: Wire</p>	<p>33.319F *</p>  <p>Material: EPDM co-ex Grip range: 1 - 2 mm Hardness: SH 70 Density: 0,6 Insert: 26 x 0,75 mm wire Flammehæmmende Flame retardant ref. NNF 16101 (Certificate valid only 2016) Min. order: 3.000 m</p>

* Skaffevare Special order item

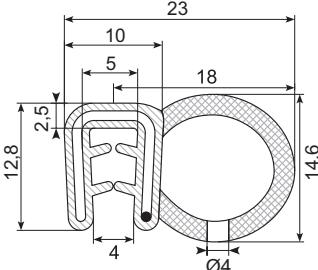
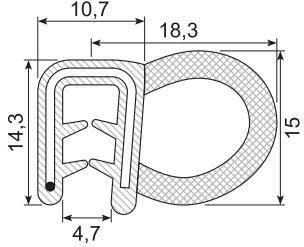
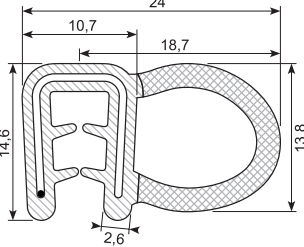
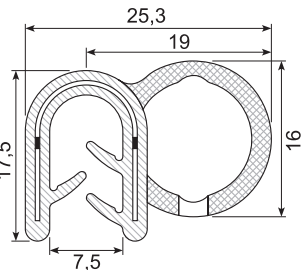
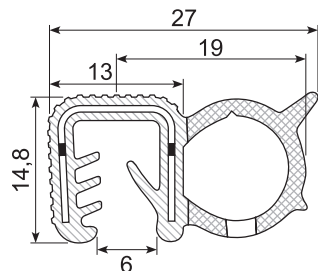
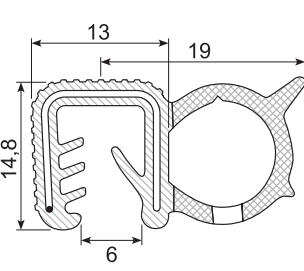
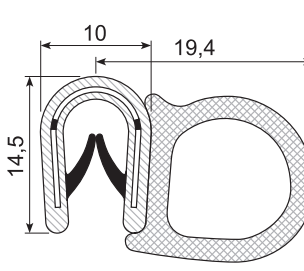
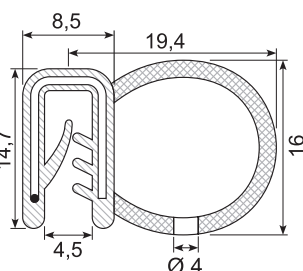
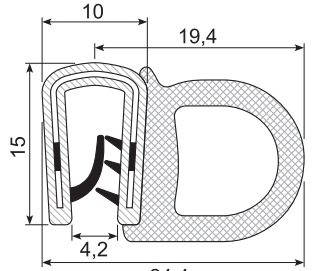
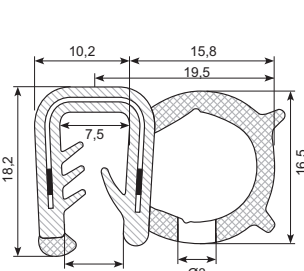
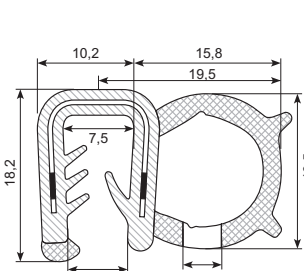
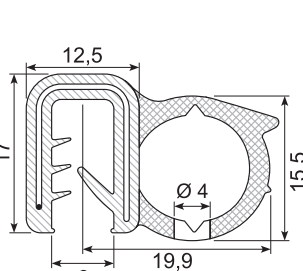
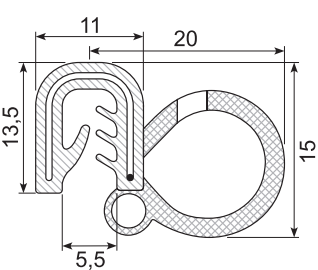
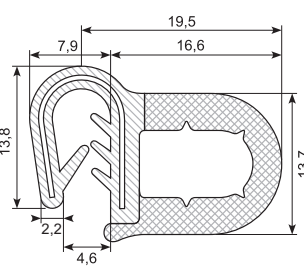
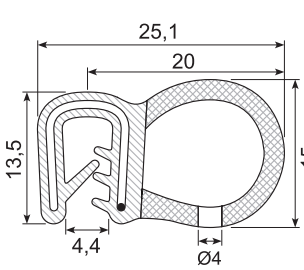
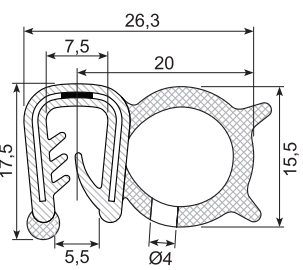
<p>33.323</p>  <p>Material: EPDM co-ex Grip range: 1,5 - 3,5 mm Hardness: SH 70 Density: 0,6 - 0,85 Insert: 27 mm</p>	<p>33.324CR</p>  <p>Material: CR co-ex Grip range: 1 - 3,5 mm Hardness: SH 70 Density: 0,6 - 0,85 Insert: 29 mm wire Betinget oliebestandig <i>Conditional oil resistant</i></p>	<p>33.338F</p>  <p>Material: EPDM co-ex Grip range: 1,5 - 3 mm Hardness: SH 65 Density: 0,60 Insert: 30 x 0,75 mm wire Flammehæmmende <i>Flame retardant EN45545</i></p>	<p>33.450NBR</p>  <p>Material: NBR co-ex Grip range: 4 - 6 mm (3-6) Hardness: SH 70 Density: 0,55 Insert: 34 x 0,5 mm steel Oliebestandig <i>Oil resistant</i></p>
<p>33.457</p>  <p>Material: EPDM co-ex Grip range: 5 - 6 mm Hardness: SH 60 Density: 0,6 Insert: 32 x 0,6 mm steel, Unbroken</p>	<p>33.457ST</p>  <p>Material: EPDM co-ex Grip range: 5 - 6 mm Hardness: SH 60 Density: 0,55 Insert: 31 x 0,76 mm wire</p>	<p>33.449</p>  <p>Material: PVC, black +bi / sponge rubber Grip range: 1 - 4 mm Hardness: SH 78 / 57 Density: 0,55 Insert: 26 x 0,5 mm steel</p>	<p>33.321</p>  <p>Material: EPDM co-ex Grip range: 1 - 3,5 mm Hardness: SH 70 Density: 0,6 - 0,85 Insert: 27 mm wire</p>
<p>33.452R</p>  <p>Material: PVC, black +bi / sponge rubber Grip range: 2 - 4 mm Hardness: SH 78 / 65 Density: 0,65 - 0,75 Insert: 29 x 0,48 mm Rustfri stål <i>Stainless steel</i></p>	<p>33.457S-5</p>  <p>Material: EPDM co-ex Grip range: 1,5 - 4 (1,5-5 mm) Hardness: SH 70 Density: 0,6 Insert: 32 x 0,47 steel</p>	<p>33.457S-6</p>  <p>Material: EPDM co-ex Grip range: 3 - 6 mm Hardness: SH 70 Density: 0,6 Insert: 32 x 0,47 steel</p>	<p>33.024</p>  <p>Material: EPDM co-ex Grip range: 2 - 4 mm (2-5) Hardness: SH 70 Density: 0,55 Insert: 33 mm wire</p>
<p>33.454X</p>  <p>Material: EPDM co-ex Grip range: 2 mm Hardness: SH 70 Density: 0,55 Insert: 27 x 0,76 mm wire</p>	<p>33.451E</p>  <p>Material: EPDM co-ex Grip range: 2 - 5 mm Hardness: SH 70 Density: 0,6 Insert: 30 mm steel</p>	<p>33.335</p>  <p>Material: EPDM co-ex Grip range: 1,5 - 3,5 mm Hardness: SH 70 Density: 0,55-0,85 Insert: 27 mm wire</p>	<p>33.457S-4 *</p>  <p>Material: EPDM co-ex Grip range: 2 - 4 mm Hardness: SH 70 Density: 0,6 Insert: Steel Min. order: 3.000 m</p>

* Skaffevare Special order item

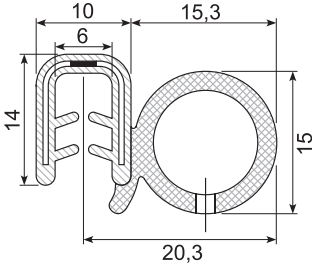
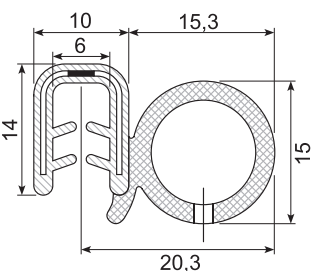
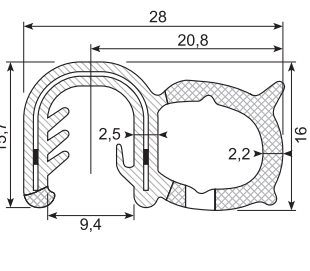
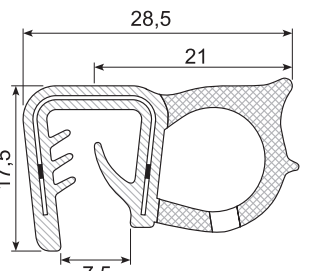
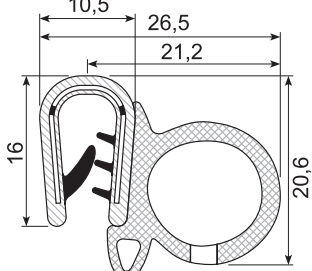
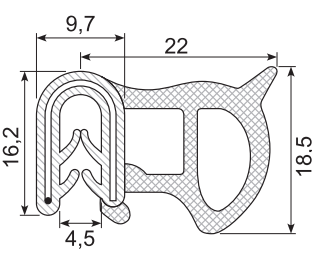
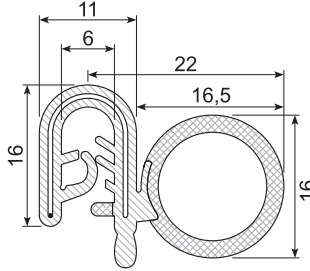
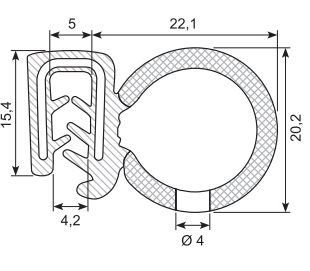
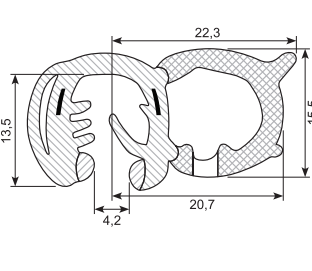
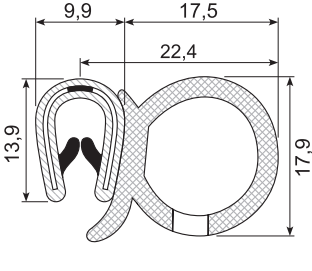
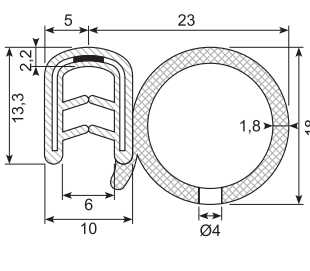
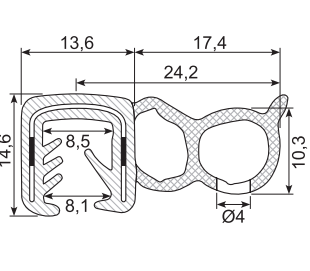
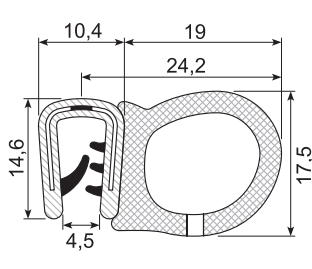
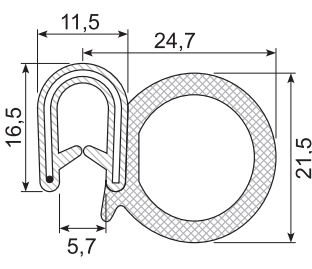
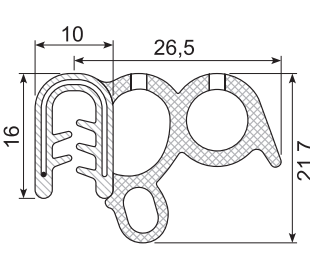
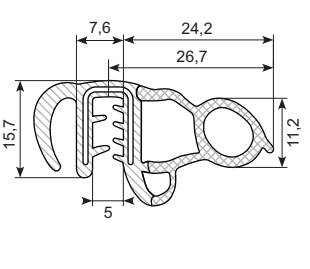
33.020	33.020NBR **	33.332X	33.470
 <p>Material: EPDM co-ex Grip range: 1,5 - 3 mm Hardness: SH 70 Density: 0,55 Insert: 27 x 0,47 mm steel</p>	 <p>Material: NBR co-ex Grip range: 1,5 - 3 mm Olieb Bestandig Oil resistant Min. order: 2.000 m</p>	 <p>Material: EPDM co-ex Grip range: 5 - 6 mm Hardness: SH 70 Density: 0,6 Insert: 33 x 0,5 steel Min. order: 450 m</p>	 <p>Material: EPDM co-ex Grip range: 5 - 8 mm Hardness: SH 70 Density: 0,6 Insert: 36 x 0,5 mm steel</p>
33.339X	33.12116	33.022	33.340
 <p>Material: PVC, black+bi / sponge rubber Grip range: 2,5 - 4 mm Hardness: SH 78 / 65 Insert: Steel</p>	 <p>Material: EPDM co-ex Grip range: 1 - 4 mm Hardness: SH 70 Density: 0,6 - 0,85 Insert: 29 mm wire Min. order: 3.000 m</p>	 <p>Material: EPDM co-ex Grip range: 1,5 - 3 mm (1,5 - 4) Hardness: SH 70 Density: 0,6 Insert: 33 mm wire</p>	 <p>Material: EPDM co-ex Grip range: 2 - 4 mm Hardness: SH 70 Insert: 29 x 0,74 mm steel</p>
33.332B	33.453X	33.019	33.455
 <p>Material: EPDM co-ex Grip range: 3 - 6 mm Hardness: SH 70 Density: 0,55 Insert: 32 x 0,47 mm Steel Min. order: 1.000 m</p>	 <p>Material: PVC, black + sponge rubber Grip range: 1 - 3,5 mm Hardness: SH75 / 75 Density: 0,6 - 0,85 Insert: 26 x 0,47 mm steel</p>	 <p>Material: EPDM co-ex Grip range: 1 - 4 mm Hardness: SH 70 Density: 0,6 - 0,85 Insert: Steel</p>	 <p>Material: EPDM co-ex Grip range: 4 - 6 mm Hardness: SH 70 Density: 0,6 Insert: Steel, unbroken</p>
33.452X	33.326	33.464	33.466
 <p>Material: PVC, black + bi / sponge rubber Grip range: 2 - 4 mm Hardness: SH 78 / 65 Density: 0,65 - 0,75 Insert: 29 x 0,48 mm</p>	 <p>Material: EPDM co-ex Grip range: 1,5 - 4 mm Hardness: SH 70 Density: 0,55 - 0,85 Insert: 33 mm wire</p>	 <p>Material: EPDM co-ex Grip range: 1,5 - 3,5 mm Hardness: SH 70 Density: 0,6 Insert: 31 x 0,75 mm wire</p>	 <p>Material: EPDM co-ex Hardness: SH 70 +- 5 Grip range: 1,5 - 3 mm Density: 1,3 +- 0,03</p>

*** Skaffevare Special order item**

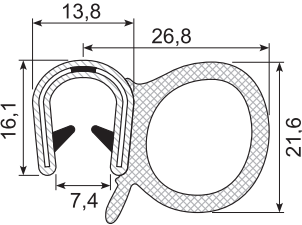
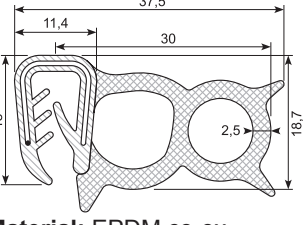
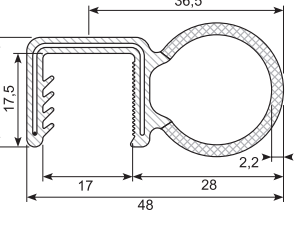
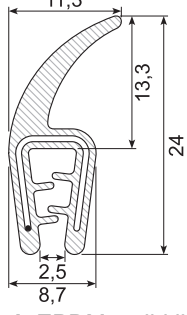
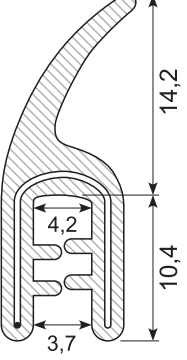
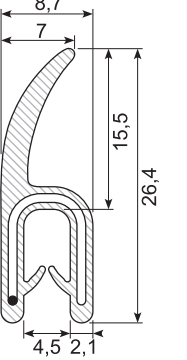
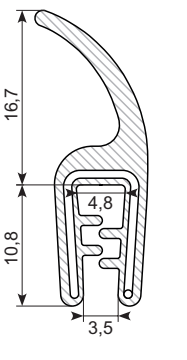
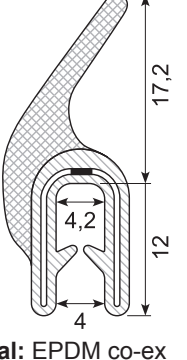
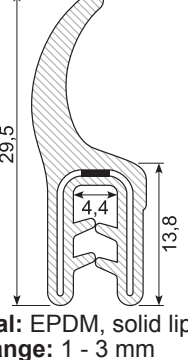
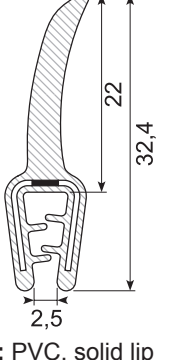
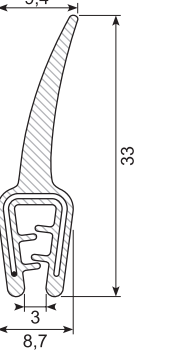
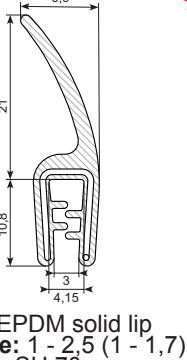
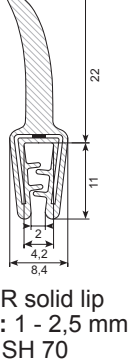
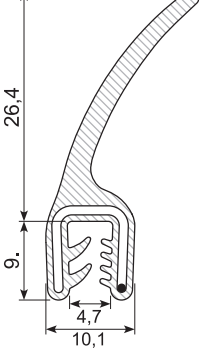
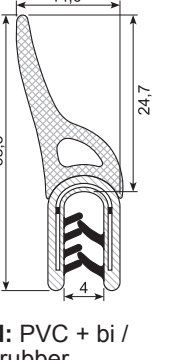
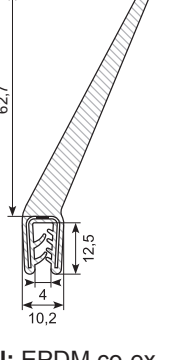
<p>33.331 *</p>  <p>Material: PVC, black + sponge rubber Grip range: 6 - 8 mm Hardness: SH75 / 75 Density: 0,6 - 0,85 Insert: 30 x 0,47 mm steel Hvide læber <i>White lips</i></p>	<p>33.456F</p>  <p>Material: EPDM co-ex Grip range: 2 - 4 mm Hardness: SH 65 Density: 0,6 Insert: 31 x 0,75 mm wire Flammehæmmende Flame retardant NNF 16101 (Certificate valid only 2016) Min. order: 3.000 m</p>	<p>33.478 *</p>  <p>Material: EPDM co-ex Grip range: 16 mm Hardness: SH 60 Density: 0,6 Insert: 52 x 0,76 mm wire Min. order: 3.000 m</p>	<p>33.458X</p>  <p>Material: EPDM, solid lip Grip range: 1 - 2,5 mm Hardness: SH 60 Insert: 26 x 0,76 mm wire Discontinued when sold Alternative e.g. 33.458A</p>
<p>33.458A</p>  <p>Material: EPDM co-ex Grip range: 1 - 3 mm Hardness: SH 70 Insert: Wire</p>	<p>33.465C</p>  <p>Material: EPDM solid lip Grip range: 2 - 4 mm Hardness: SH 70 Insert: 27 x 0,76 wire</p>	<p>33.465A</p>  <p>Material: EPDM, solid lip Grip range: 1 - 3 mm Hardness: SH 70 Insert: 27 x 0,74 wire</p>	<p>33.479 *</p>  <p>Material: EPDM co-ex Grip range: 2 - 4 mm Hardness: SH 70 Density: 0,6 Insert: Steel</p>
<p>33.465B</p>  <p>Material: EPDM, solid lip Grip range: 1 - 3 mm Hardness: SH 70 Insert: 27 x 0,5 mm steel Unbroken Min. order: 3.000 m</p>	<p>33.459P</p>  <p>Material: PVC, solid lip Grip range: 1 - 2,5 mm Hardness: SH 57 Insert: 24 x 0,5 mm steel, Unbroken</p>	<p>33.459A</p>  <p>Material: EPDM solid lip Grip range: 1 - 2,5 mm Hardness: SH 70 Insert: 27 x 0,74 wire</p>	<p>33.459XA *</p>  <p>Material: EPDM solid lip Grip range: 1 - 2,5 (1 - 1,7) Hardness: SH 70 Insert: 27 x 0,74 wire Flammehæmmende Flame retardant Min. order: 3.000 m</p>
<p>33.459XB</p>  <p>Material: CR solid lip Grip range: 1 - 2,5 mm Hardness: SH 70 Insert: 26 x 0,74 wire Betinget oliebestandig Conditional oil resistant Min. order: 3.000 m</p>	<p>33.459B</p>  <p>Material: EPDM solid lip Grip range: 1,5 - 3 mm Hardness: SH 70 Insert: Wire</p>	<p>33.475</p>  <p>Material: PVC + bi / sponge rubber Grip range: 2 - 4 mm Hardness: SH 78 / 57 Density: 0,55 Insert: Steel</p>	<p>33.382</p>  <p>Material: EPDM co-ex, solid lip Grip range: 1 - 3,5 mm Hardness: SH 70 Insert: Steel</p>

* Skaffevare Special order item

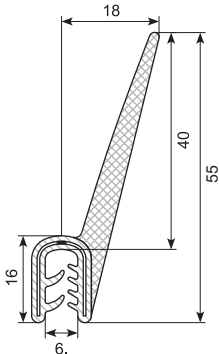
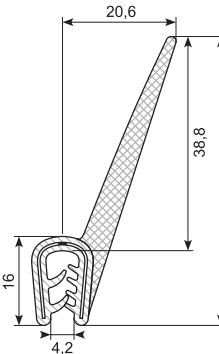
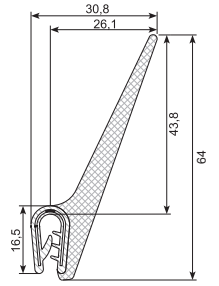
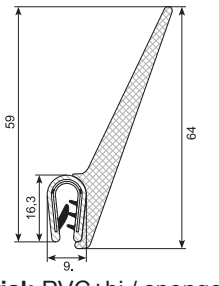
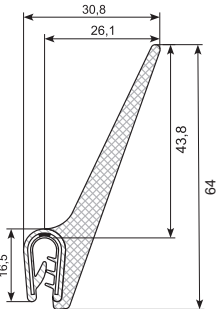
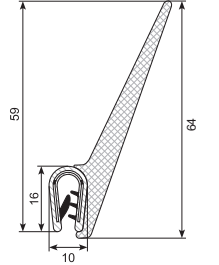
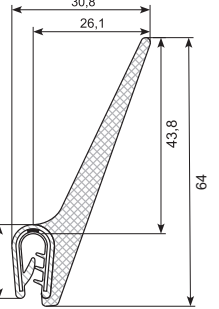
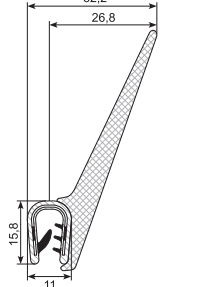
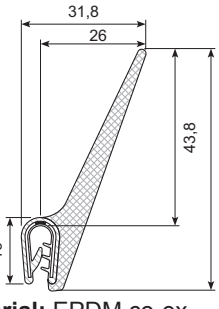
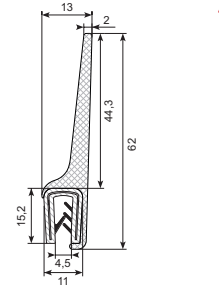
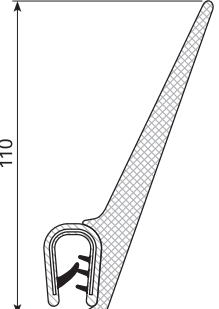
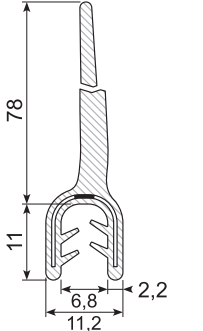
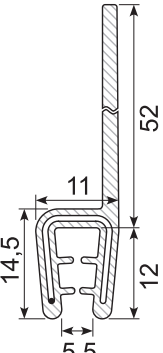
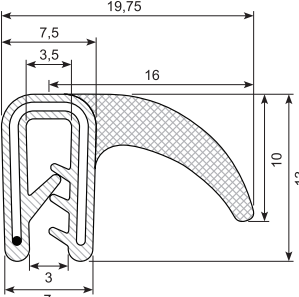
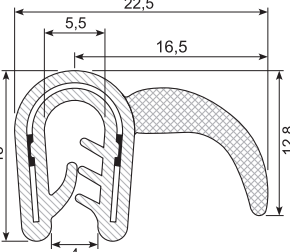
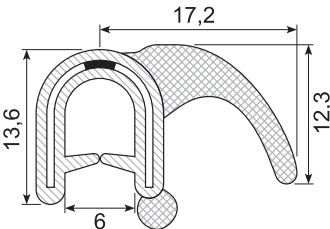
<p>33.482</p>  <p>Material: EPDM co-ex, solid lip Grip range: 2 - 4,5 mm Hardness: SH 70 Insert: 30 x 0,47 mm steel</p>	<p>33.483</p>  <p>Material: EPDM co-ex, solid lip Grip range: 1 - 2,5 mm Hardness: SH 70 Insert: 30 x 0,47 mm steel</p>	<p>33.460-2F *</p>  <p>Material: EPDM co-ex Grip range: 1 - 2,5 mm Hardness: SH 65 Density: 0,6 Insert: 31 x 0,5 mm steel Flammehämmende Flame retardant ref. NNF 16101 (Certificate valid only 2016) Min. order: 3.000 m</p>	<p>33.460-2X</p>  <p>Material: PVC+bi / sponge rubber Grip range: 1 - 2,5 mm Hardness: SH 78 / 57 Density: 0,6 Insert: 31 x 0,5 mm steel Discontinued when sold. Alternative e.g. 33.460-2C</p>
<p>33.460-2C</p>  <p>Material: EPDM co-ex Grip range: 1 - 2,5 mm Hardness: SH 70 Density: 0,6 Insert: 31 x 0,5 mm steel, No gluing, Unbroken</p>	<p>33.460-4X</p>  <p>Edge trim: PVC+bi / sponge rubber Grip range: 2 - 4 mm Hardness: SH 78/57 Density: 0,6 Insert: 31 x 0,5 mm steel Discontinued when sold. Alternative e.g. 33.460-4C</p>	<p>33.460-4C</p>  <p>Material: EPDM co-ex Grip range: 2 - 4 mm Hardness: SH 70 Density: 0,6 Insert: 31 x 0,5 mm steel, No gluing, unbroken</p>	<p>33.460-6A *</p>  <p>Material: PVC+bi / sponge rubber Grip range: 4 - 6 mm Hardness: SH 78/57 Density: 0,6 Insert: 31 x 0,5 mm steel Min. order: 2-4.000 m</p>
<p>33.460-6C</p>  <p>Material: EPDM co-ex Grip range: 4 - 6 mm Hardness: SH 70 Density: 0,6 Insert: 31 x 0,5 mm steel No gluing, unbroken Min. order: 2-3.000 m</p>	<p>33.460-6K *</p>  <p>Material: PVC / sponge rubber Grip range: 4 - 6 mm Hardness: SH 70 Density: 0,6 Insert: 31 x 0,5 mm steel, Unbroken Min. order: 2-4.000 m</p>	<p>33.460-6XL</p>  <p>Material: PVC+bi / sponge rubber Grip range: 3 - 6 mm Hardness: SH 75 / 57 Density: 0,6 Insert: Steel</p>	<p>33.472 *</p>  <p>Material: EPDM, solid lip Grip range: 2 - 4 mm Hardness: SH 70 Insert: 29 x 0,5 mm Unbroken</p>
<p>33.471</p>  <p>Material: EPDM, solid lip Grip range: 3 - 4 mm Hardness: SH 60 solid lip Insert: 29 x 0,76 mm wire</p>	<p>33.443X</p>  <p>Material: EPDM co-ex Grip range: 1 - 2 mm Hardness: SH 60 Density: 0,6 Insert: Wire</p>	<p>33.383</p>  <p>Material: EPDM co-ex Grip range: 2 - 4 mm Hardness: SH 70 Density: 0,6 Insert: 30 x 0,5 steel</p>	<p>33.474</p>  <p>Material: EPDM co-ex Grip range: 2 - 5 mm Hardness: SH 70 Density: 0,6 - 0,85 Insert: 27 mm steel</p>

* Skaffevare Special order item

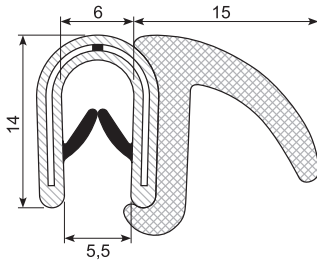
33.439A

Material: PVC+bi / sponge rubber
Grip range: 1 - 4 mm
Hardness: SH 78 / 57
Density: 0,6
Insert: 26 x 0,5 mm steel
Gule læber *Yellow lips*

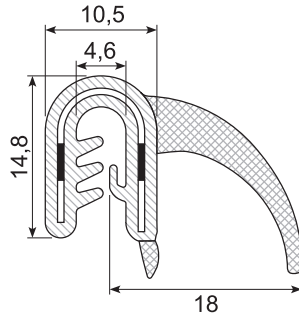
33.026

Material: EPDM co-ex
Grip range: 1,5 - 2 mm (1 - 3,5)
Hardness: SH 70
Density: 0,55
Insert: 26 x 0,76 mm wire

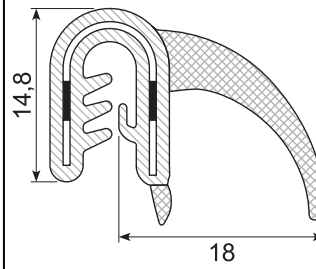
33.026XA

Material: EPDM co-ex
Grip range: 2 - 3 mm
Hardness: SH 70
Density: 0,55
Insert: 26 x 0,76 mm wire

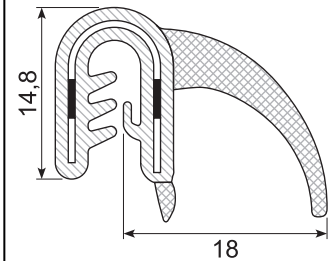
33.026X

Material: EPDM co-ex
Grip range: 3 - 4 mm
Hardness: SH 70
Density: 0,55
Insert: 26 x 0,76 mm wire

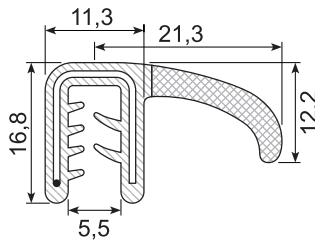
33.436

Material: EPDM co-ex
Grip range: 2 - 4 mm
Hardness: SH 70
Density: 0,6
Insert: 33 mm wire

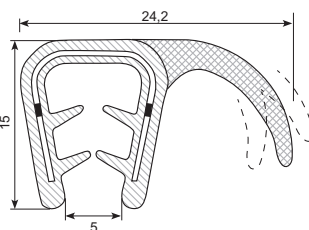
33.386

Material: EPDM co-ex
Grip range: 4 - 6 mm
Hardness: SH 70
Density: 0,6
Steel: 31x0,5

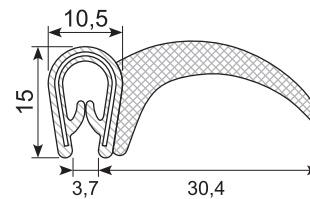
33.442

Material: EPDM co-ex
Grip range: 1 - 3 mm
Hardness: SH 70
Density: 0,65
Insert: 29 mm steel

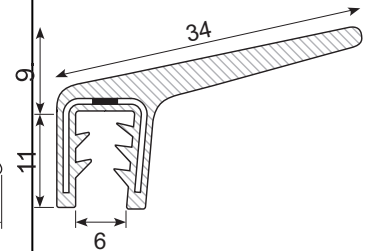
33.473

Material: EPDM co-ex
Grip range: 2 - 5 mm
Hardness: SH 70
Insert: 27 x 0,47 mm steel

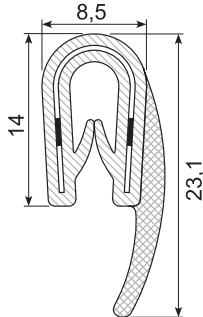
33.462

Material: PVC / sponge rubber
Grip range: 1 - 2,5 mm
Hardness: SH 78
Density: 0,65 - 0,75
Insert: 25 x 0,48 mm steel

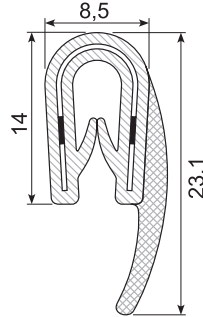
33.462R

Material: PVC / sponge rubber
Grip range: 1 - 2,5 mm
Hardness: SH 78
Density: 0,65 - 0,75
Insert: 25 x 0,48 mm
Rustfri stål *Stainless steel*

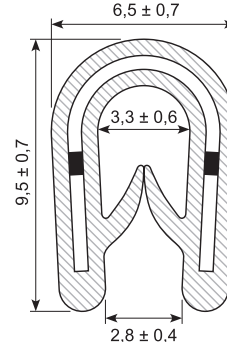
33.409ALU

Material: PVC, black
Grip range: 0,8 - 2 mm
Hardness: SH 75
Insert: 17,5 mm aluminium
Min. order: 10.000 m

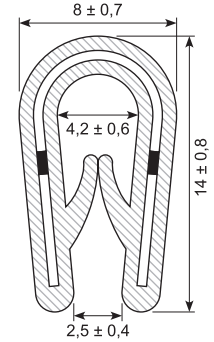
33.310ALU

Material: PVC, black
Grip range: 1 - 2,5 mm
Hardness: SH 75
Insert: 26 mm aluminium
Min. order: 10.000 m

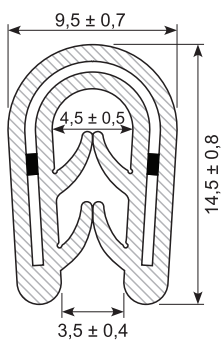
33.432ALU

Material: EPDM
Grip range: 2 - 4 mm
Hardness: SH 65
Insert: 26 mm aluminium
Min. order: 10.000 m

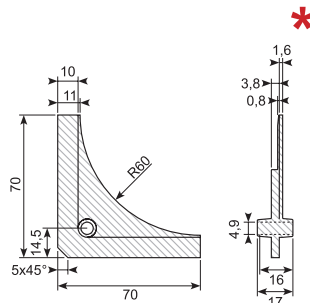
33.000

Hjørnestykke i nylon. Sikrer korrekt hjørneradius
Nylon corner piece. Ensures correct corner radius
 PA6 + 30% GF
Min. order: 100

*** Skaffevare Special order item**

Silikonekantlister

Silicone edge trims

Silikonekantlister anvendes som andre typer af kantlister. Silikone er dog meget mere resistent overfor højere temperaturer.

Vi tilbyder ligeledes FDA egnede silikonelister og / eller op til 270 °C varmebestandighed.

The silicone edge trims are used like other types of edge trims. However, silicone is much more resistant to higher temperatures.

We also offer FDA-approved silicone edge trims and / or with heat tolerance up to 270 °C.

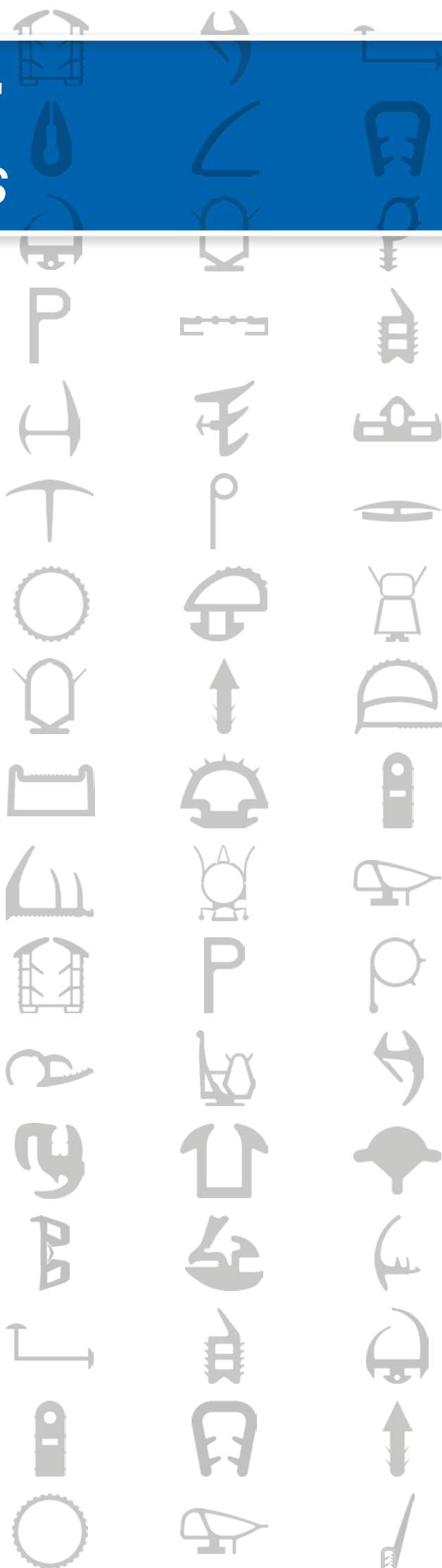

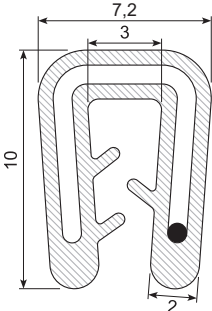
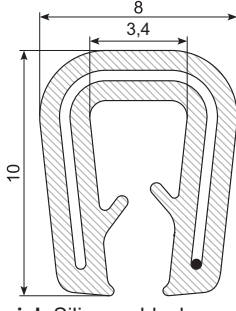
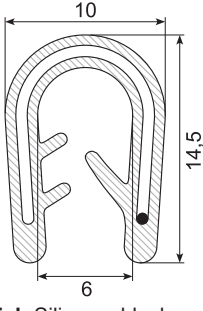
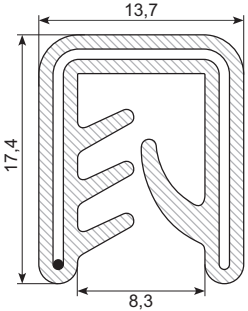
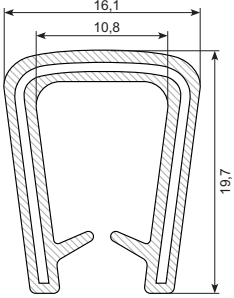
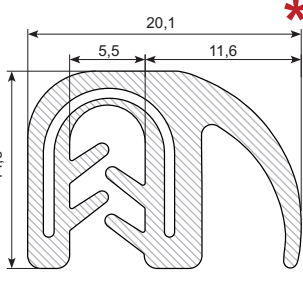
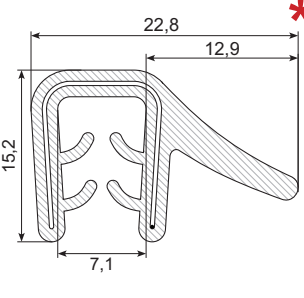
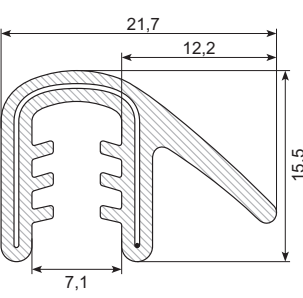
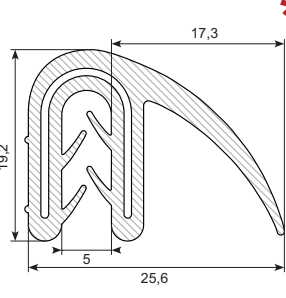
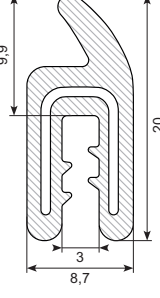
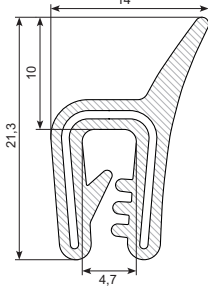
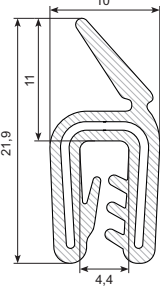
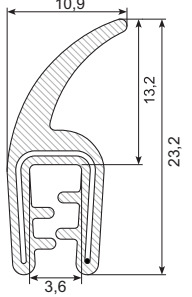
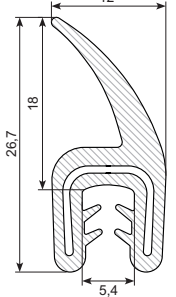
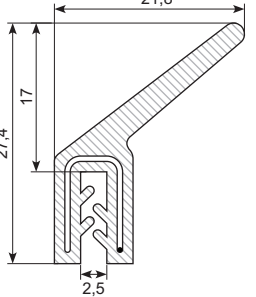
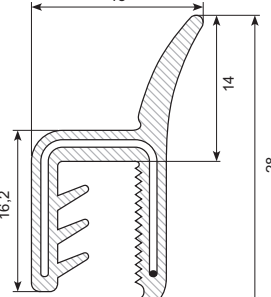
<p>33.311</p>  <p>Material: Silicone, black, FDA conform Grip range: 1 - 2 mm Hardness: SH 60 Insert: Wire 18 x 0,76 mm Varmebestandig Heat resistant 200° C</p>	<p>33.510 *</p>  <p>Material: Silicone, black, FDA conform Grip range: 1 - 2 mm Hardness: SH 65 Insert: Wire 26 x 0,76 mm Varmebestandig Heat resistant 200° C Min. order: 500 m</p>	<p>33.312 *</p>  <p>Material: Silicone, black, FDA conform Grip range: 3 - 4 mm Hardness: SH 60 Insert: Wire Varmebestandig Heat resistant 200° C Min. order: 500 m</p>	<p>33.429 *</p>  <p>Material: Silicone, black, FDA conform Grip range: 2,5 - 5 mm (5 - 7) Hardness: SH 60 Insert: Wire 39 x 0,76 mm Varmebestandig Heat resistant 200° C</p>
<p>33.534 *</p>  <p>Material: Silicone, black, FDA conform Grip range: 5 - 8 mm Hardness: SH 70 + - 5 Insert: Wire Varmebestandig Heat resistant 200° C Min. order: 500 m</p>	<p>33.537 *</p>  <p>Material: Silicone, black, FDA conform Grip range: 2 - 4 mm Hardness: SH 60 + - 5 Insert: Wire Varmebestandig Heat resistant 200° C Min. order: 500 m</p>	<p>33.531 *</p>  <p>Material: Silicone, black, FDA conform Grip range: 2,5 - 5 mm Hardness: SH 70 Insert: Wire Varmebestandig Heat resistant 200° C Min. order: 500 m</p>	<p>33.532</p>  <p>Material: Silicone, black, FDA conform Grip range: 4 - 6 mm Hardness: SH 65 Insert: Wire Varmebestandig Heat resistant 200° C</p>
<p>33.538 *</p>  <p>Material: Silicone, black, FDA conform Grip range: 3 - 4 mm Hardness: SH 60 + - 5 Insert: Wire Varmebestandig Heat resistant 200° C Min. order: 500 m</p>	<p>33.536 *</p>  <p>Material: Silicone, black, FDA conform Grip range: 1,5 - 2,5 mm Hardness: SH 60 + - 5 Insert: Wire Varmebestandig Heat resistant 200° C Min. order: 500 m</p>	<p>33.541 *</p>  <p>Material: Silicone, black, FDA conform Grip range: 2 - 3,5 mm Hardness: SH 68 + - 5 Insert: Wire Varmebestandig Heat resistant 200° C Min. order: 500 m</p>	<p>33.540 *</p>  <p>Material: Silicone, black, FDA conform Grip range: 1 - 3 mm Hardness: SH 60 + - 5 Insert: Wire Varmebestandig Heat resistant 200° C Min. order: 500 m</p>
<p>33.527 *</p>  <p>Material: Silicone, black, FDA conform Grip range: 1 - 2,5 mm Hardness: SH 65 Insert: Wire Varmebestandig Heat resistant 200° C Min. order: 500 m</p>	<p>33.539 *</p>  <p>Material: Silicone, black, FDA conform Grip range: 3,5 - 4,5 mm Hardness: SH 60 + - 5 Insert: Wire Varmebestandig Heat resistant 200° C Min. order: 500 m</p>	<p>33.529 *</p>  <p>Material: Silicone, black, FDA conform Grip range: 1 - 2 mm Hardness: SH 80 Insert: Wire Varmebestandig Heat resistant 200° C Min. order: 500 m</p>	<p>33.530</p>  <p>Material: Silicone, black, FDA conform Grip range: 4,5 - 6 mm Hardness: SH 70 Insert: Wire Varmebestandig Heat resistant 200° C</p>

* Skaffevare Special order item

Alle silikonekantlister kan laves med rustfri stålindlæg ved min. ordre 500 m
 All silicone edge trims can be done with stainless insert at min. order. 500 m

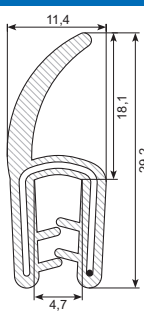
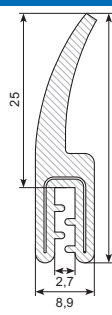
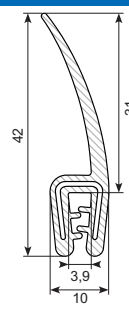
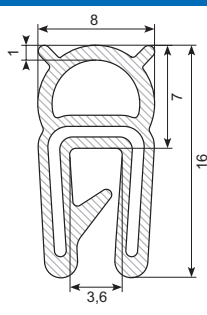
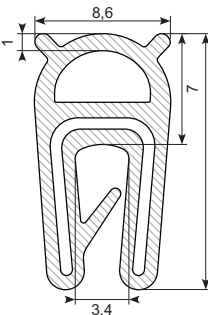
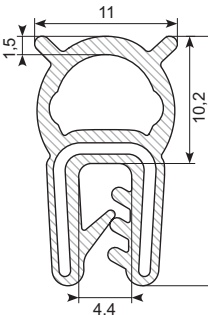
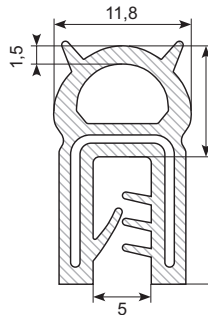
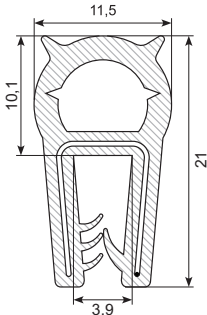
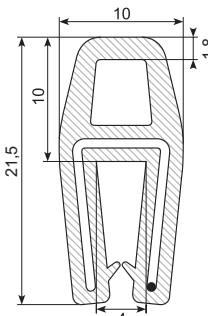
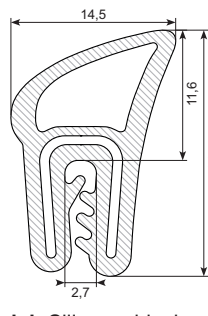
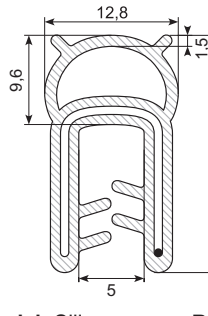
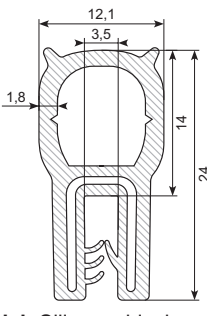
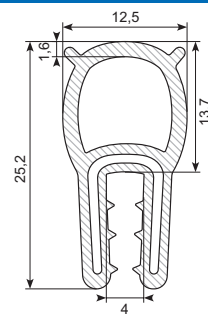
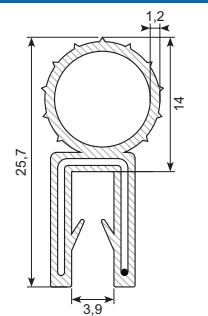
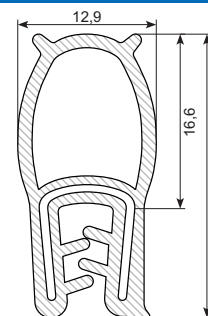
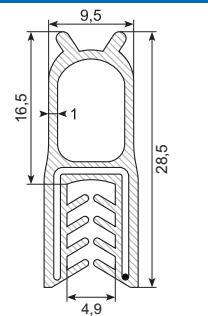
<p>33.528 *</p>  <p>Material: Silicone, black, FDA conform Grip range: 1,5 - 2 mm Hardness: SH 50 Insert: Wire Varmebestandig Heat resistant 200° C Min. order: 500 m</p>	<p>33.526 *</p>  <p>Material: Silicone, black, FDA conform Grip range: 1 - 2 mm Hardness: SH 62 Insert: Wire Varmebestandig Heat resistant 200° C Min. order: 500 m</p>	<p>33.535 *</p>  <p>Material: Silicone, black, FDA conform Grip range: 2 - 3 mm Hardness: SH 70 + - 5 Insert: Wire Varmebestandig Heat resistant 200° C Min. order: 500 m</p>	<p>33.552 *</p>  <p>Material: Silicone, black, FDA conform Grip range: 1 - 2,5 mm Hardness: SH 50 + - 5 Insert: Wire Varmebestandig Heat resistant 200° C Min. order: 500 m</p>
<p>33.555 *</p>  <p>Material: Silicone, black, FDA conform Grip range: 2 - 2,5 mm Hardness: SH 55 + - 5 Varmebestandig Heat resistant 200° C Min. order: 500 m</p>	<p>33.554 *</p>  <p>Material: Silicone, black, FDA conform Grip range: 1,5 - 2,5 Hardness: SH 65 + - 5 Varmebestandig Heat resistant 200° C Min. order: 500 m</p>	<p>33.513</p>  <p>Material: Silicone, black, FDA conform Grip range: 1,5 - 3,5 mm Hardness: SH 50 Insert: Wire Varmebestandig Heat resistant 200° C</p>	<p>33.512</p>  <p>Material: Silicone, black, FDA conform Grip range: 1,5 - 3,5 mm Hardness: SH 60 Insert: Wire Varmebestandig Heat resistant 200° C</p>
<p>33.511</p>  <p>Material: Silicone, black, FDA conform Grip range: 1,5 - 3,5 mm Hardness: SH 50 Insert: Wire Varmebestandig Heat resistant 200° C</p>	<p>33.556 *</p>  <p>Material: Silicone, black, FDA conform Grip range: 1 - 1,5 mm Hardness: SH 65 + - 5 Insert: Wire Varmebestandig Heat resistant 200° C Min. order: 500 m</p>	<p>33.431A</p>  <p>Material: Silicone, grey RAL 7035, FDA conform Grip range: 2 - 4 mm Hardness: SH 60/60, solid balloon Insert: Wire Varmebestandig Heat resistant 200° C</p>	<p>33.550 *</p>  <p>Material: Silicone, black, FDA conform Grip range: 1,5 - 2,5 Hardness: SH 50 + 5 Insert: Wire Varmebestandig Heat resistant 200° C Min. order: 500 m</p>
<p>33.553</p>  <p>Material: Silicone, black, FDA conform Grip range: 2 - 3 mm Hardness: SH 60 + - 5 Insert: Wire Varmebestandig Heat resistant 200° C Min. order: 500 m</p>	<p>33.514 *</p>  <p>Material: Silicone, black, FDA conform Grip range: 2 - 3 mm Hardness: SH 75 Insert: Wire Varmebestandig Heat resistant 200° C Min. order: 500 m</p>	<p>33.533 *</p>  <p>Material: Silicone, black, FDA conform Grip range: 1,5 - 3 mm Hardness: SH 40 Insert: Wire Varmebestandig Heat resistant 200° C Min. order: 500 m</p>	<p>33.515 *</p>  <p>Material: Silicone, black, FDA conform Grip range: 1 - 2 mm Hardness: SH 75 Insert: Wire Varmebestandig Heat resistant 200° C Min. order: 500 m</p>

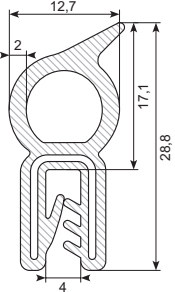
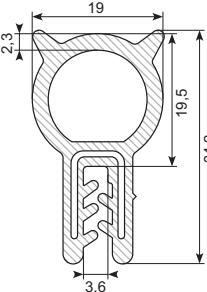
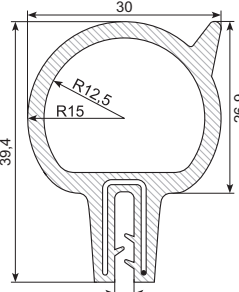
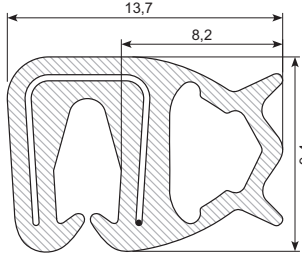
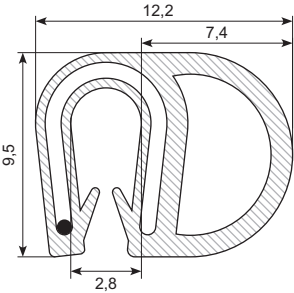
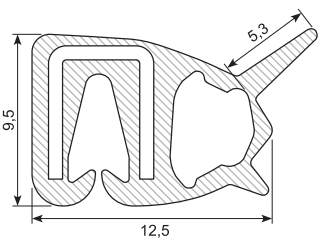
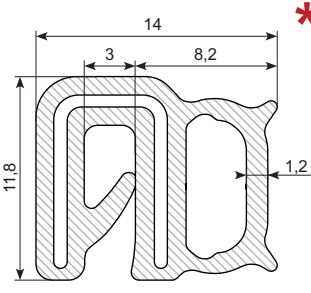
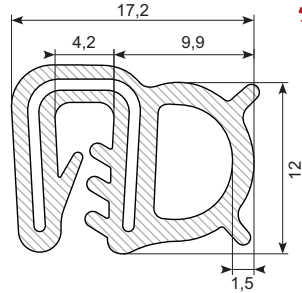
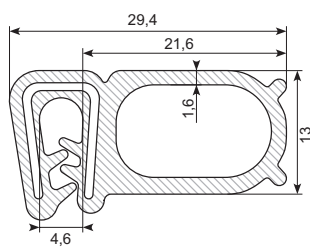
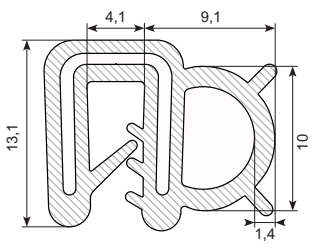
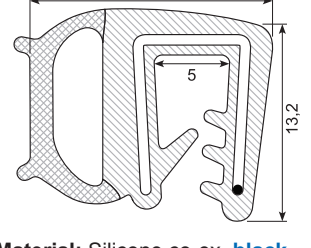
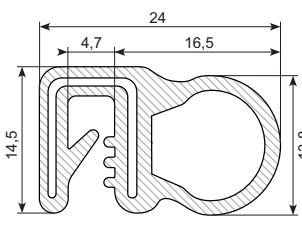
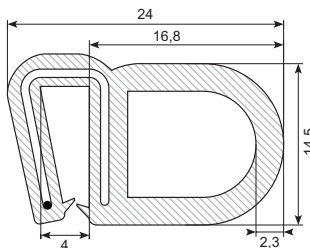
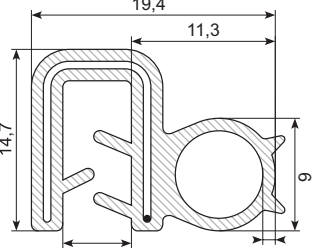
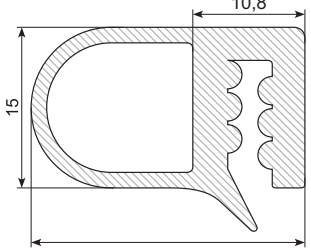
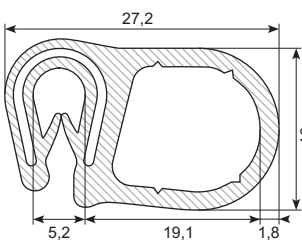
<p>33.548 *</p>  <p>Material: Silicone, black, FDA conform Grip range: 2 - 3 mm Hardness: SH 60 + - 5 Insert: Wire Varmebestandig Heat resistant 200° C Min. order: 500 m</p>	<p>33.551 *</p>  <p>Material: Silicone, black, FDA conform Grip range: 1,5 - 2,5 mm Hardness: SH 70 + - 5 Insert: Wire Varmebestandig Heat resistant 200° C Min. order: 500 m</p>	<p>33.516 *</p>  <p>Material: Silicone, black, FDA conform Grip range: 2 - 3 mm Hardness: SH 75 Insert: Wire Varmebestandig Heat resistant 200° C Min. order: 500 m</p>	<p>33.518 *</p>  <p>Material: Silicone, white, FDA conform Grip range: 2 - 3 mm Hardness: SH 60 Insert: Wire Varmebestandig Heat resistant 200° C Min. order: 500 m</p>
<p>33.517 *</p>  <p>Material: Silicone, black, FDA conform Grip range: 1,5 - 2 mm Hardness: SH 50 Insert: Wire Varmebestandig Heat resistant 200° C Min. order: 500 m</p>	<p>33.519 *</p>  <p>Material: Silicone, black, FDA conform Grip range: 2 - 2,5 mm Hardness: SH 45 Insert: Wire Varmebestandig Heat resistant 200° C</p>	<p>33.542 *</p>  <p>Material: Silicone, black, FDA conform Grip range: 1 Hardness: SH 65 + - 5 Insert: Wire Varmebestandig Heat resistant 200° C Min. order: 500 m</p>	<p>33.544 *</p>  <p>Material: Silicone, black, FDA conform Grip range: 1 - 3 mm Hardness: SH 65 + - 5 Insert: Wire Varmebestandig Heat resistant 200° C Min. order: 500 m</p>
<p>33.547 *</p>  <p>Material: Silicone, black, FDA conform Grip range: 2 - 3,5 mm Hardness: SH 60 + - 5 Insert: Wire Varmebestandig Heat resistant 200° C Min. order: 500 m</p>	<p>33.546 *</p>  <p>Material: Silicone, black, FDA conform Grip range: 1 - 3 Hardness: SH 60 + - 5 Insert: Wire Varmebestandig Heat resistant 200° C Min. order: 500 m</p>	<p>33.520 *</p>  <p>Material: Silicone co-ex, black and redbrown, FDA conform Grip range: 3 - 4 mm Hardness: SH 60 Density: 0,4 Insert: Wire Varmebestandig Heat resistant 200° C Min. order: 500 m</p>	<p>33.543 *</p>  <p>Material: Silicone, black, FDA conform Grip range: 2 - 3,5 mm Hardness: SH 75 + - 5 Insert: Wire Varmebestandig Heat resistant 200° C Min. order: 500 m</p>
<p>33.524 *</p>  <p>Material: Silicone, black, FDA conform Grip range: 3 - 4,5 mm Hardness: SH 55 Insert: Wire Varmebestandig Heat resistant 200° C Min. order: 500 m</p>	<p>33.521 *</p>  <p>Material: Silicone, black, FDA conform Grip range: 3 - 4,5 mm Hardness: SH 50 Insert: Wire Varmebestandig Heat resistant 200° C</p>	<p>33.523 *</p>  <p>Material: Silicone, black, FDA conform Grip range: 1,5 - 2 mm Hardness: SH 60 Insert: Wire Varmebestandig Heat resistant 200° C Min. order: 500 m</p>	<p>33.545 *</p>  <p>Material: Silicone, black, FDA conform Grip range: 1,5 - 3 mm Hardness: SH 60 + - 5 Insert: Wire Varmebestandig Heat resistant 200° C Min. order: 500 m</p>

* Skaffevare Special order item

Alle silikonekantlister kan laves med rustfri stålindlæg ved min. ordre 500 m
 All silicone edge trims can be done with stainless insert at min. order. 500 m

33.525

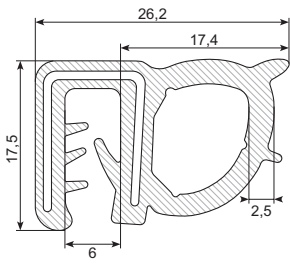

Material: Silicone, black,
FDA conform
Grip range: 3 - 4 mm
Hardness: SH 50
Insert: Wire
Varmebestandig
Heat resistant 200° C
Min. order: 500 m

33.848

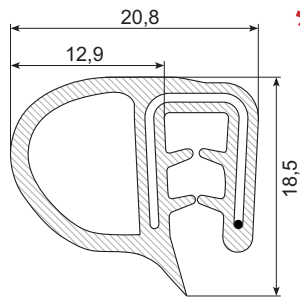

Material: Silicone, black,
FDA conform
Grip range: 2 - 4 mm
Hardness: SH 60
Insert: Wire
Varmebestandig
Heat resistant 200° C
Min. order: 500 m

POM-profiler

POM-profiles

POM-profiler har plastikindlæg, og de kan være et alternativ til kantlister med stål- eller metalindlæg. POM-profiler har mange gode egenskaber:

- God fleksibilitet
- Vejer meget mindre end profiler med metalindlæg
- Kan ikke ruste eller oxidere
- Større sikkerhed ved montering - ingen rifter fra skarpe metalstykker
- I modsætning til profiler med metalindlæg er POM-profiler ikke ledende, og de kan derfor anvendes til beskyttelse eller overflademateriale

POM profiles have plastic inserts and can be an alternative to edgings with steel or metal inserts. POM profiles have many great properties:

- *Good flexibility*
- *Much lighter than metal-based profiles*
- *Cannot corrode or oxidize*
- *Safer mountin - no cuts from sharp metal edges*
- *Unlike profiles with metal inlays, POM-profiles are non-conductive and can therefore be used as a protection or surface material*

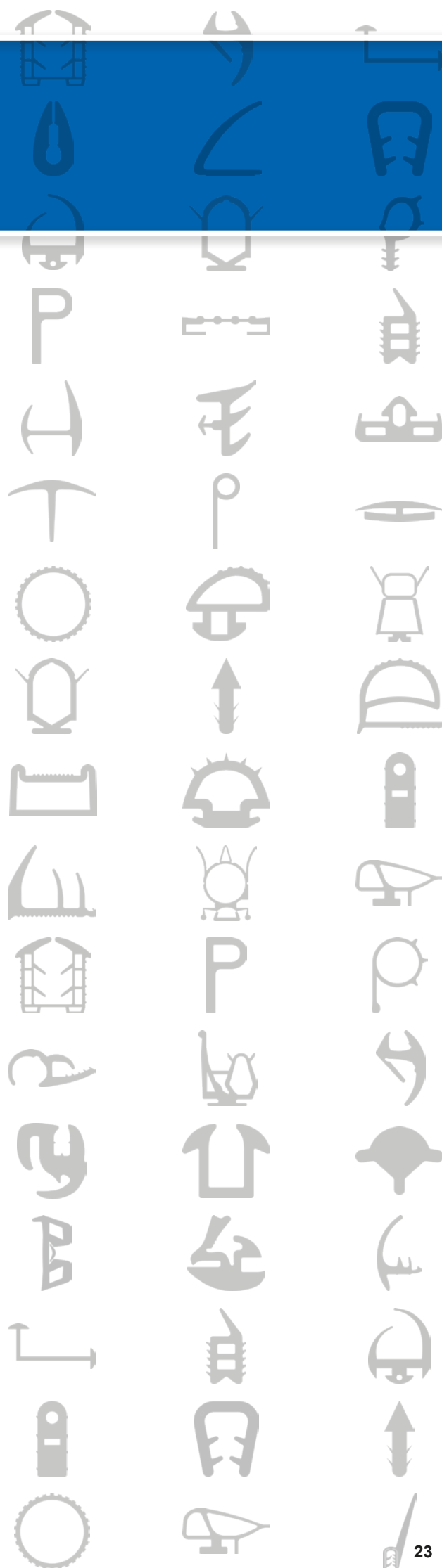

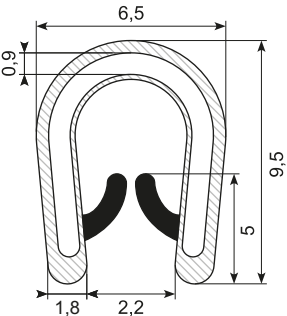
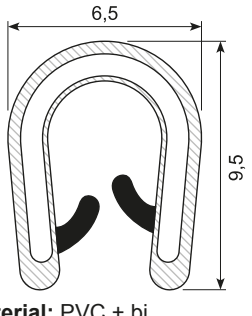
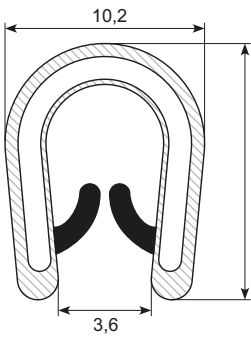
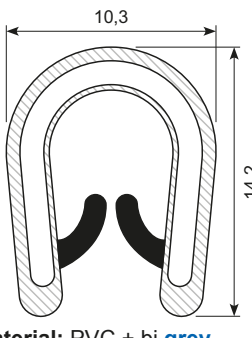
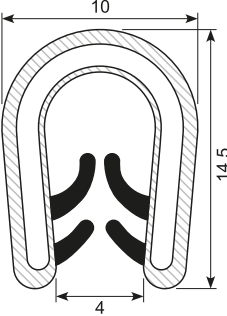
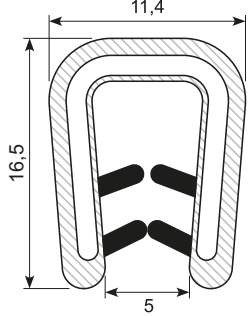
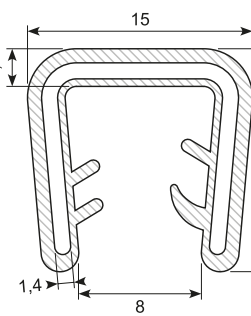
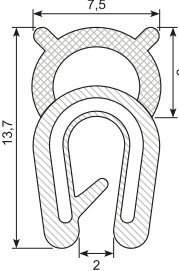
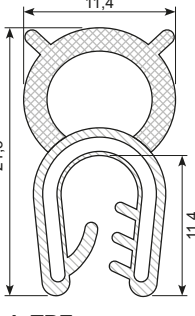
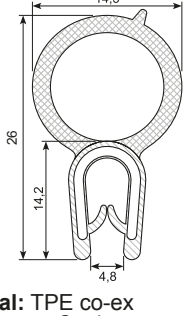
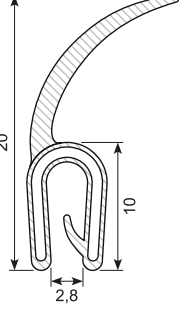
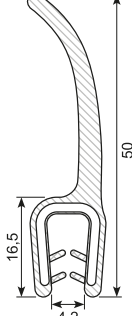
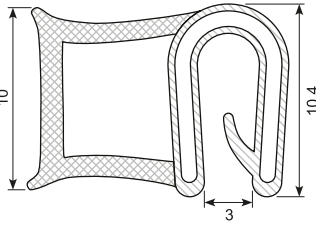
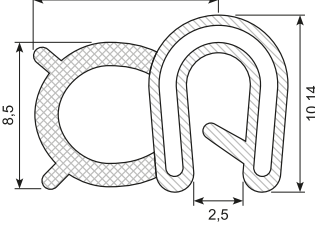
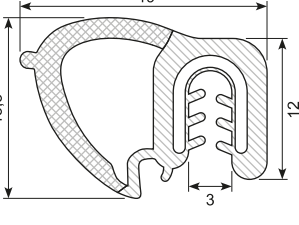
<p>33.409POM * (33.409POMX)</p>  <p>Material: PVC + bi Grip range: 1 - 2,5 mm (0,5 - 2 mm) Hardness: SH 75 / 65 Insert: POM plastic Ingen rust, nem at skære <i>No rust, easy cutting</i></p>	<p>33.410POMX</p>  <p>Material: PVC + bi Grip range: 0,8 - 1,5 mm Hardness: SH 75 / 65 Insert: POM plastic Ingen rust, nem at skære <i>No rust, easy cutting</i> Udgår: fejlleverance Discontinued: misdelivery</p>	<p>33.308POM</p>  <p>Material: PVC + bi Grip range: 1 - 3,5 mm Hardness: SH 75 / 65 Insert: POM plastic Ingen rust, nem at skære <i>No rust, easy cutting</i></p>	<p>33.308POMG * (33.308POMXG)</p>  <p>Material: PVC + bi grey Grip range: 1 - 3,5 mm (2 - 4,5 mm) Hardness: SH 75 / 65 Insert: POM plastic Ingen rust, nem at skære <i>No rust, easy cutting</i></p>
<p>33.200POM * (33.200POMX)</p>  <p>Material: PVC + bi Grip range: 2 - 5 mm (1 - 4 mm) Hardness: SH 75 / 65 Insert: POM plastic Ingen rust, nem at skære <i>No rust, easy cutting</i></p>	<p>33.201POM</p>  <p>Material: PVC + bi Grip range: 2 - 4 mm Hardness: SH 75 / 65 Insert: POM plastic Ingen rust, nem at skære <i>No rust, easy cutting</i></p>	<p>33.203POM * (33.203POMX)</p>  <p>Material: PVC + bi Grip range: 6 - 8 mm Hardness: SH 75 / 65 Insert: POM plastic Ingen rust, nem at skære <i>No rust, easy cutting</i></p>	<p>33.210POM * (33.210POMX)</p>  <p>Material: TPE co-ex Grip range: 1,5 - 2,5 mm (1 - 2 mm) Hardness: SH 75 Density: 0,65 Insert: POM plastic Ingen rust, nem at skære <i>No rust, easy cutting</i> Min. order: 1.000 m</p>
<p>33.211POM *</p>  <p>Material: TPE co-ex Grip range: 1,5 - 3 mm Hardness: SH 75 Density: 0,65 Insert: POM plastic Ingen rust, nem at skære <i>No rust, easy cutting</i></p>	<p>33.212POM</p>  <p>Material: TPE co-ex Grip range: 2 - 4 mm Hardness: SH 75 Density: 0,65 Insert: POM plastic Ingen rust, nem at skære <i>No rust, easy cutting</i></p>	<p>33.220POM</p>  <p>Material: TPE Grip range: 1,5 - 2,5 mm Hardness: SH 75 Density: 0,65 Insert: POM plastic Ingen rust, nem at skære <i>No rust, easy cutting</i></p>	<p>33.221POM</p>  <p>Material: TPE Grip range: 2 - 4 mm Hardness: SH 75 Insert: POM plastic Ingen rust, nem at skære <i>No rust, easy cutting</i></p>
<p>33.214POM</p>  <p>Material: TPE co-ex Grip range: 1,5 - 3 mm Hardness: SH 75 Density: 0,65 Insert: POM plastic Ingen rust, nem at skære <i>No rust, easy cutting</i></p>	<p>33.213POMX2</p>  <p>Material: TPE co-ex Grip range: 1 - 2,5 mm Hardness: SH 75 Density: 0,65 Insert: POM plastic Ingen rust, nem at skære <i>No rust, easy cutting</i></p>	<p>33.215POM</p>  <p>Material: TPE co-ex Grip range: 1 - 2 mm Hardness: SH 75 Density: 0,65 Insert: POM plastic Ingen rust, nem at skære <i>No rust, easy cutting</i></p>	

* Skaffevare Special order item

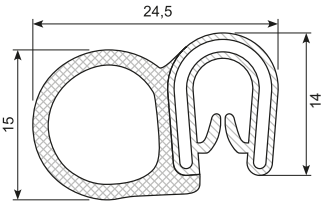
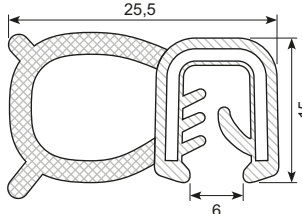
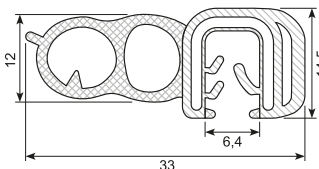
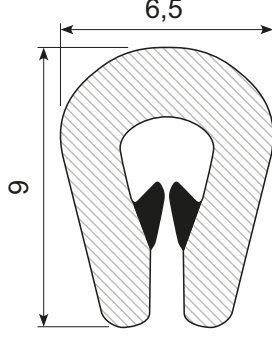
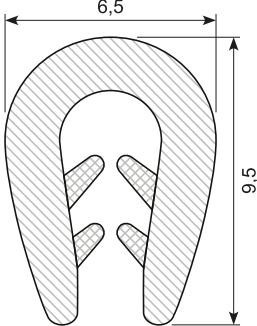
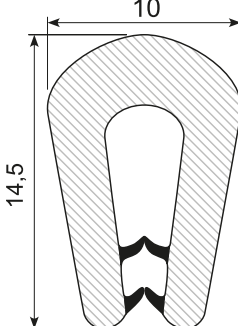
33.216POM	33.217POM *	33.218POM *	33.424
 <p>Material: TPE co-ex Grip range: 1,5 - 3 mm Hardness: SH 75 Density: 0,65 Insert: POM plastic Ingen rust, nem at skære <i>No rust, easy cutting</i></p>	 <p>Material: TPE co-ex Grip range: 1,5 - 4 mm Hardness: SH 75 Density: 0,65 Insert: POM plastic Ingen rust, nem at skære <i>No rust, easy cutting</i> Min. order: 2.000 m</p>	 <p>Material: TPE co-ex Grip range: 1,5 - 4 mm Hardness: SH 75 Density: 0,65 Insert: POM plastic Ingen rust, nem at skære <i>No rust, easy cutting</i> Min. order: 2.000 m</p>	 <p>Material: TPE + bi Grip range: 0,8 - 2,5 mm Hardness: SH 87 / 65 - 90 Insert: None Alternative: 33.424TPEX</p>
33.424TPEX (33.424TPE)	33.417TPEX (33.417TPE)		
 <p>Material: TPE + bi Grip range: 1 - 2 mm (0,5 - 1,5 mm) Hardness: SH 90 / 50 Insert: None</p>	 <p>Material: TPE + bi Grip range: 1 - 4 mm (0,5 - 2 mm) Hardness: SH 90 / 50 Insert: None</p>		

Energioptimering

BIBUS SINDBY A/S iværksatte i september 2022 en proces, hvor vi gennemgik vores el- og gasforbrug. Med en ny investering i belysning samt en simpel adfærsændring, lykkedes vi med at reducere vores elforbrug med over **40%**. Vi offentliggør vores forbrug internt en gang i måneden for konstant at holde hinanden op på bedre forbrugsvaner. På vores hjemmeside kan du se hvordan vores energiforbrug har udviklet sig. Vil du høre mere om vores tiltag, så er du altid velkommen til at kontakte os.

*In September 2022, BIBUS SINDBY A/S initiated a process to review our electricity and gas consumption. With a new investment in lighting and a simple behavioural change, we managed to reduce our electricity consumption by over **40%**.*

We publish our consumption internally once a month to constantly keep each other up on better consumption habits. On our website you can see how our energy consumption has evolved. If you want to know more about our initiatives, please feel free to contact us.



Gummisnor

Rubber cord

Gummisnor anvendes som pakningsmateriale og kan monteres i f.eks. et udfræset spor eller limes på.

Uanset hvilken gummisnor du har brug for, har vi løsningen til dig. I vores sortiment fører vi gummisnor i forskellige størrelser (fra 1 - 40 mm) og gummityper. Gummisnorene kan anvendes til mange formål.

Rubber cord profiles are used as gasket material and can be inserted in a cutout or glued on.

Whatever rubber cord profile you need, we have the solution for you. In our assortment we have rubber cord profiles in different sizes (from 1 - 40 mm) and materials. The rubber cords can be used for many purposes.

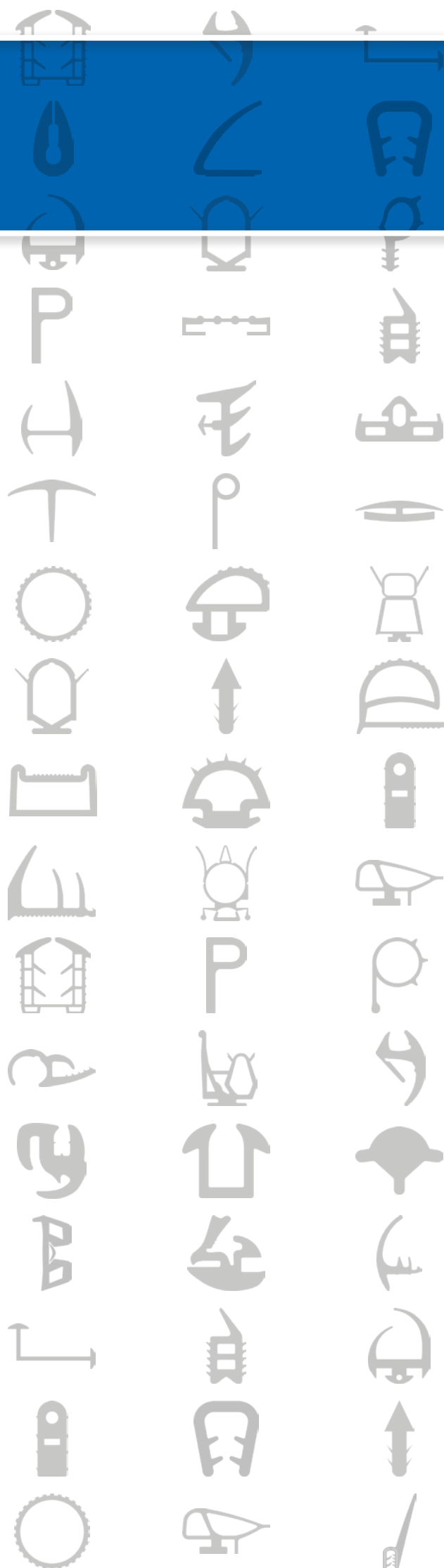

Gummisnor *Rubber cord*

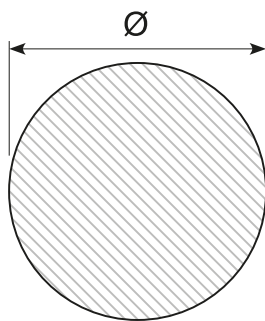

EPDM, sort *black* Shore A 65 - 70

Varenr. <i>Item no.</i>	Ø
30.101 *	1 mm
30.101.25 *	1,25 mm
30.101.5	1,5 mm
30.102	2 mm
30.102E *	2 mm <i>Single cord</i>
30.103E *	3 mm
30.103EX	3 mm
30.104E *	4 mm
30.104.5E *	4,5 mm
30.105E	5 mm
30.106E	6 mm
30.107E	7 mm
30.108E	8 mm
30.109E	9 mm
30.110E	10 mm
30.112E *	12 mm
30.113E	13 mm
30.114E *	14 mm
30.115E *	15 mm
30.116E *	16 mm
30.117E	17 mm
30.118E	18 mm
30.119E	19 mm
30.120E	20 mm
30.121E *	21 mm
30.122E	22 mm
30.124E	24 mm
30.125E *	25 mm
30.135E *	35 mm <i>(SH 75)</i>

CR, sort *black* Shore A 60

Varenr. <i>Item no.</i>	Ø
30.103CR *	3 mm
30.103.5CR *	3,5 mm
30.104CR	4 mm
30.104.5CR *	4,5 mm
30.105CR *	5 mm
30.105.3CR *	5,3 mm
30.105.7CR *	5,7 mm
30.106CR *	6 mm
30.106.5CR *	6,5 mm
30.107CR *	7 mm
30.107.5CR *	7,5 mm
30.108CR *	8 mm
30.108.4CR *	8,4 mm
30.109CR *	9 mm
30.109.5CR *	9,5 mm
30.110CR *	10 mm
30.111CR *	11 mm
30.112CR *	12 mm
30.113CR *	13 mm
30.114CR *	14 mm
30.115CR *	15 mm
30.116CR *	16 mm
30.118CR	18 mm
30.120CR *	20 mm
30.122CR *	22 mm
30.125CR *	25 mm
30.130CR *	30 mm
30.132CR *	32 mm
30.140CR *	40 mm
30.150CR *	50 mm

NBR, sort *black* Shore A 65

Varenr. <i>Item no.</i>	Ø
30.102NBR *	2 mm
30.103NBR	3 mm
30.103.5NBR *	3,5 mm
30.104NBR *	4 mm
30.104.5NBR *	4,5 mm
30.105NBR *	5 mm
30.105.3NBR *	5,3 mm
30.105.7NBR *	5,7 mm
30.106NBR *	6 mm
30.106.5NBR *	6,5 mm
30.107NBR *	7 mm
30.107.5NBR *	7,5 mm
30.108NBR *	8 mm
30.108.4NBR *	8,4 mm
30.109NBR *	9 mm
30.109.5NBR *	9,5 mm
30.110NBR *	10 mm
30.111NBR *	11 mm
30.112NBR *	12 mm
30.113NBR *	13 mm
30.114NBR *	14 mm
30.116NBR *	16 mm
30.118NBR *	18 mm
30.120NBR *	20 mm
30.122NBR *	22 mm
30.125NBR *	25 mm
30.130NBR *	30 mm
30.132NBR *	32 mm
30.135NBR *	35 mm
30.140NBR *	40 mm

Silicone, gennemsigtig *translucent* Shore A 60

Varenr. <i>Item no.</i>	Ø
30.103SIH *	3 mm
30.104SIH *	4 mm
30.105SIH	5 mm
30.106SIH	6 mm
30.108SIH *	8 mm
30.108SIHX *	8 mm

Elastiksnor *Elastic cord*

Varenr. <i>Item no.</i>	Ø
50.260-4	4 mm
50.260-5	5 mm
50.260-6	6 mm
50.260-8	8 mm
50.260-10	10 mm
50.260-10T <i>Trampoline cord, black</i>	10 mm

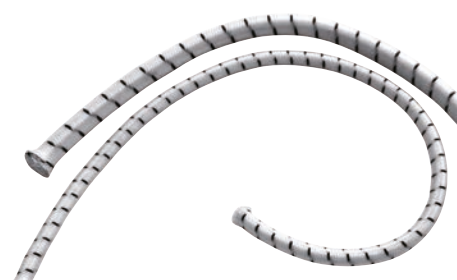

* Skaffevare *Special order item*

Specialprofiler

Special profiles

I denne gruppe finder du nogle af vores knap 7.000 specialprofiler. De kan bruges som forsegling mellem to flader.

In this group you will find some of our almost 7.000 special profiles. They are used as a seal between two surfaces.

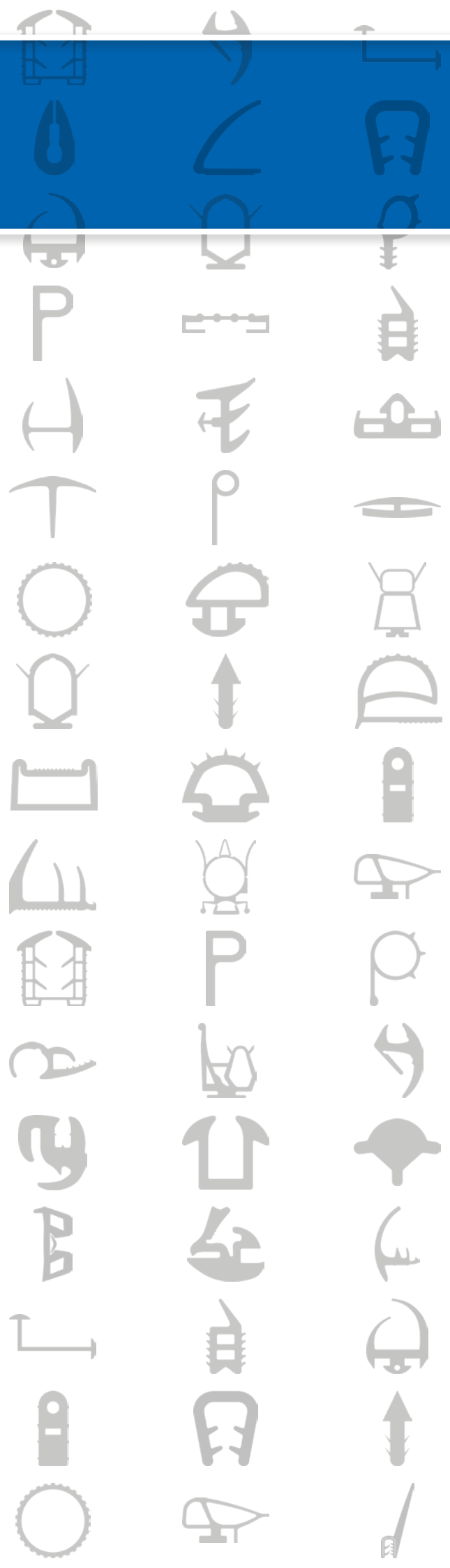

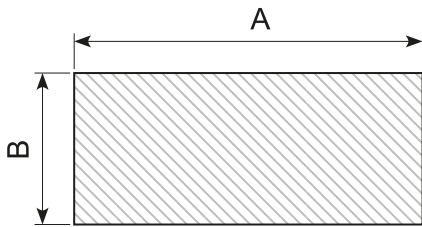

Flere størrelser kan skaffes.
På vores hjemmeside finder du den komplette liste af [firkant/retangulærprofiler](#) eller scan QR-koden forneden.

More sizes are available. On our website you will find the complete list of [square/rectangular profiles](#) or scan the QR code below



Varenr. <i>Item no.</i>	Materiale <i>Material</i>	A	B	Hårdhed <i>Hardness</i>	Klæb <i>Adhesive</i>	Min. <i>order</i>
30.1201KE *	EPDM	12 mm	1 mm	SH 65	Ja <i>Yes</i>	2.000 m
30.2005E *	EPDM	20 mm	5 mm	SH 65	Nej <i>No</i>	3.000 m
30.2310E *	EPDM	23 mm	10 mm	SH 60	Nej <i>No</i>	500 m
30.2505E *	EPDM	25 mm	5 mm	SH 65	Nej <i>No</i>	3.000 m
30.3003E	EPDM	30 mm	3 mm	SH 65	Nej <i>No</i>	
30.3006E *	EPDM	30 mm	6 mm	SH 65	Nej <i>No</i>	3.000 m
30.3305E *	EPDM	33 mm	5 mm	SH 65	Nej <i>No</i>	3.000 m
30.3310E *	EPDM	33 mm	10 mm	SH 65	Nej <i>No</i>	2.000 m
30.4003E	EPDM	40 mm	3 mm	SH 65	Nej <i>No</i>	
30.5003E	EPDM	50 mm	3 mm	SH 65	Nej <i>No</i>	
30.5003K	SBR	50 mm	3 mm	SH 70	Ja <i>Yes</i>	
30.5004E *	EPDM	50 mm	4 mm	SH 60	Nej <i>No</i>	600 m
30.5005E *	EPDM	50 mm	5 mm	SH 65	Nej <i>No</i>	2.000 m
30.5010E *	EPDM	50 mm	10 mm	SH 65	Nej <i>No</i>	1.500 m
30.5808E *	EPDM	58 mm	8 mm	SH 65	Nej <i>No</i>	1.500 m
30.6502.5E *	EPDM	65 mm	2,5 mm	SH 65	Nej <i>No</i>	500 m
30.6705E *	EPDM	67 mm	5 mm	SH 65	Nej <i>No</i>	2.000 m
30.6710E *	EPDM	67 mm	10 mm	SH 65	Nej <i>No</i>	1.000 m
30.7505E *	SBR	75 mm	5 mm	SH 65	Nej <i>No</i>	1.500 m
30.10003K	EPDM	100 mm	3 mm	SH 70	Ja <i>Yes</i>	
30.10005E *	EPDM	100 mm	5 mm	SH 65	Nej <i>No</i>	1.500 m
30.15005E *	EPDM	150 mm	5 mm	SH 65	Nej <i>No</i>	1.000 m
30.15005KE	EPDM	150 mm	5 mm	SH 65	Ja <i>Yes</i>	

Flere størrelser kan skaffes ved forespørgsel
Other sizes can be obtained on request

<p>30.262S</p> <p>Material: EPDM, black Hardness: SH 65 - 75</p>	<p>30.WI660</p> <p>Material: EPDM Hardness: SH 60 External: 40 x 45 x 5 mm</p>	<p>30.7367</p> <p>Material: CR, black Hardness: SH 65 Betinget oliebestandig <i>Conditional oil resistant</i></p>	<p>30.9691-5500 *</p> <p>Material: EPDM, white Hardness: SH 65 Fixed length: 5.500 mm Min. order: 1.100 m</p>
<p>30.7696</p> <p>Material: CR, black Hardness: SH 65 Betinget oliebestandig <i>Conditional oil resistant</i></p>	<p>30.12759</p> <p>Material: EPDM, black Hardness: SH 60</p>	<p>30.OT1024 */ 30.OT1024B</p> <p>Material: Silicone Hardness: SH 60 With adhesive 30.OT1024 *: White 30.OT1024B: Black</p>	<p>30.216S</p> <p>Material: EPDM, black Hardness: SH 65</p>

* Skaffevare *Special order item*

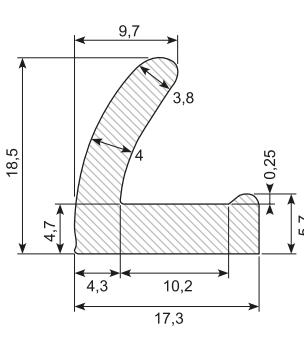
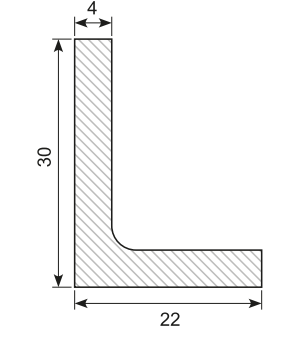
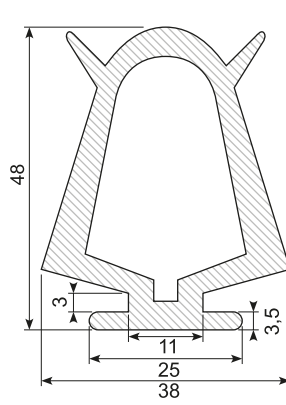
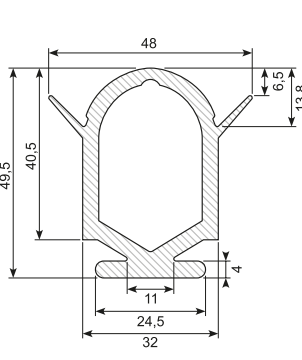
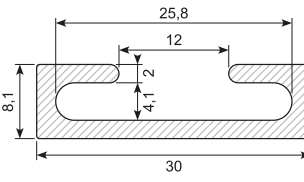
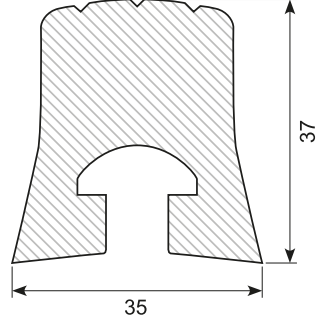
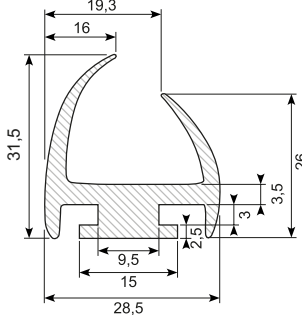
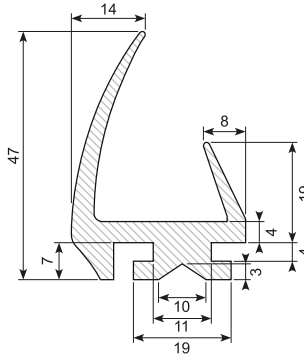
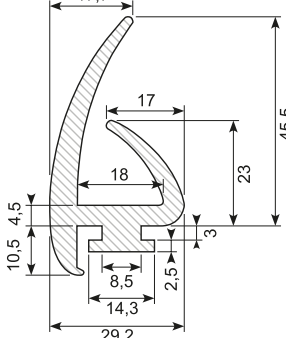
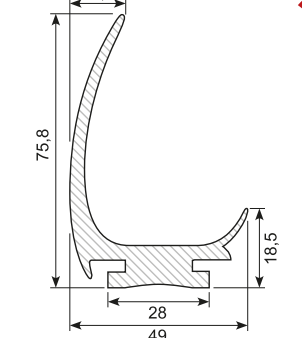
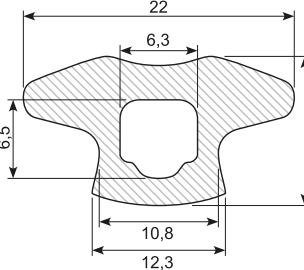
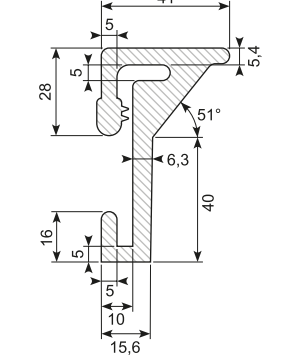
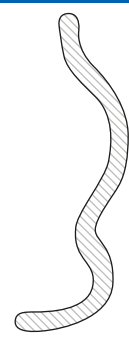
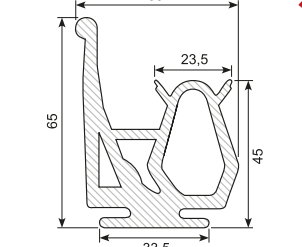
<p>30.218S</p>  <p>Material: EPDM, black Hardness: SH 75 - 81</p>	<p>30.220L</p>  <p>Material: CR, black Hardness: SH 65 Length: 6,5 m Betinget oliebestandig <i>Conditional oil resistant</i></p>	<p>30.331</p>  <p>Material: EPDM, black Hardness: SH 70</p>	<p>30.9996-10</p>  <p>Material: EPDM Hardness: SH 70</p>
<p>41.675A / 41.674A</p>  <p>Material: Aluminium 41.674A: 5 m anodiseret <i>anodized</i> 41.675A: 5,2 m ubehandlet <i>untreated</i></p>	<p>39.1208P</p>  <p>Fenderprofil med kanal <i>Fender profile with channel</i> Material: PE Length: 3 m</p>		<p>30.7933</p>  <p>H-profil til aluminiumsskinne <i>H-profile for aluminium rail</i> Material: EPDM Hardness: SH 70</p>
<p>30.12957-2</p>  <p>Material: EPDM Hardness: SH 65 Length: 4,3 m</p>		<p>30.7932</p>  <p>Gummiprofil til alu-skinne <i>Rubber profile for alu-track</i> Material: EPDM Hardness: SH 70</p>	<p>30.7935 *</p>  <p>Material: EPDM, black Hardness: SH 65 Length: 2,8 m Min. order: 22,4 m</p>
<p>30.7652</p>  <p>Material: EPDM Hardness: SH 65</p>	<p>30.333X</p>  <p>L-profile Material: EPDM Hardness: SH 70 Rulle med <i>Roll of 50 m</i></p>	<p>41.333S</p>  <p>Stålprofil til montering af gummiprofil 30.333 <i>Steel profile for mounting of rubber profile 30.333</i> Length: 2,6 m</p>	<p>30.8469 *</p>  <p>Læsebagsmækprofil med vandnøse, alu. <i>Rubber profile with drip cap. For loading tail board</i> Material: EPDM Hardness: SH 67 Length: 8 m Min. order: 80 m</p>

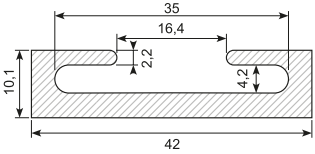
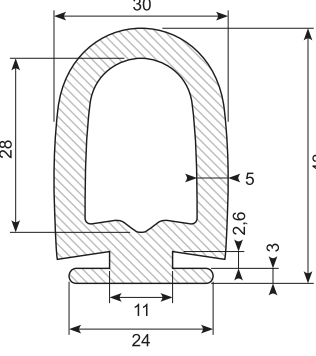
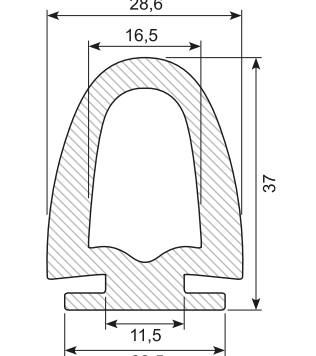
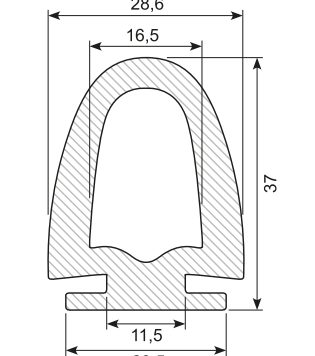
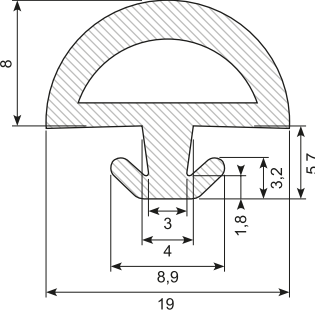
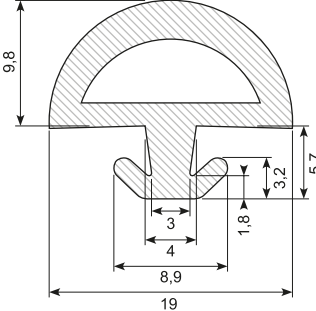
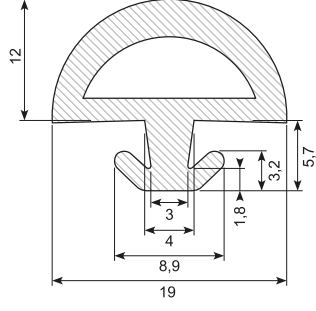
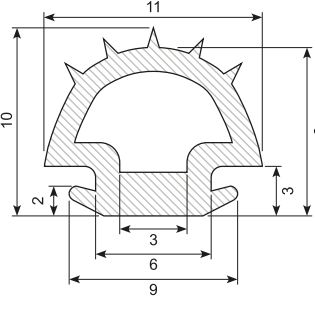
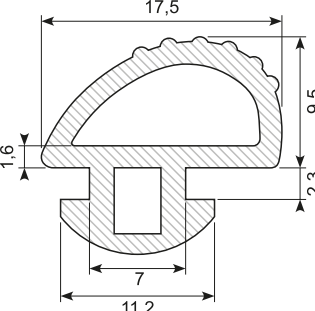
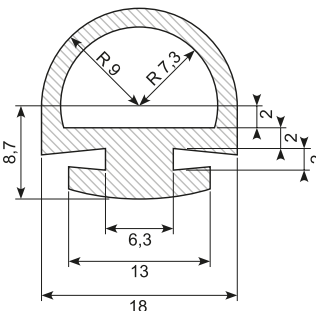
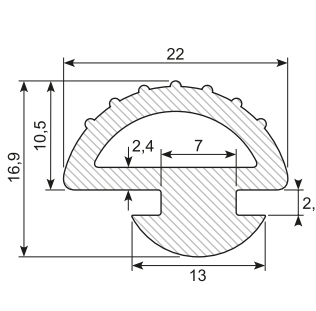
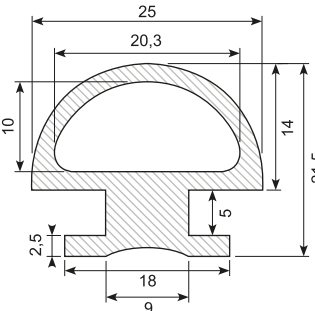
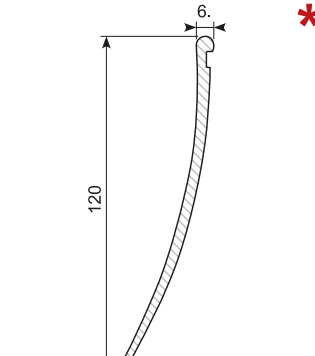
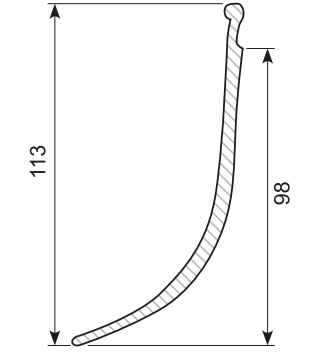
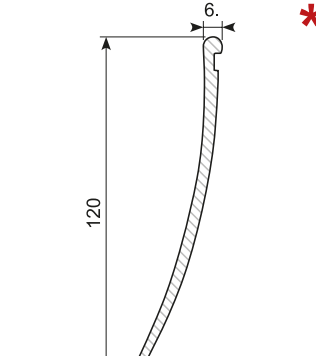
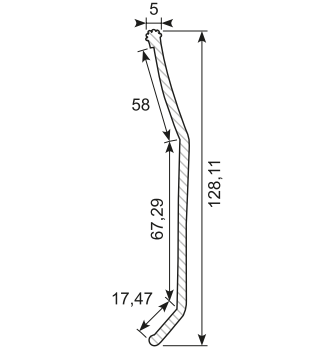
<p>41.678</p>  <p>Alu C-profil Length: 5,2 m Passer til <i>Fits 30.8469</i></p>	<p>30.325X</p>  <p>Material: EPDM, black Hardness: SH 65 Length: 5 m</p>	<p>30.324S</p>  <p>Material: EPDM, black Hardness: SH 65 Length: 5 m</p>	<p>30.324SB</p>  <p>Material: EPDM, black Hardness: SH 45 (blød <i>soft</i>) Length: 5 m</p>
<p>30.7649-8</p>  <p>D-tætningsprofil <i>D-weatherstrip</i> Material: EPDM, black Hardness: SH 60 Min. order: 1.000 m</p>	<p>30.7649</p>  <p>D-tætningsprofil <i>D-weatherstrip</i> Material: EPDM, black Hardness: SH 60</p>	<p>30.7649-12</p>  <p>D-tætningsprofil <i>D-weatherstrip</i> Material: EPDM, black Hardness: SH 60 Min. order: 1.000 m</p>	<p>30.12957-3</p>  <p>Material: EPDM Hardness: SH 60</p>
<p>30.14098-2</p>  <p>Material: EPDM Hardness: SH 60</p>	<p>30.9691-3</p>  <p>Material: EPDM, black Hardness: SH 65</p>	<p>30.7650</p>  <p>D-tætningsprofil <i>D-weatherstrip</i> Material: EPDM Hardness: SH 70</p>	<p>30.5881</p>  <p>Material: CR, black Hardness: SH 65 Betinget oliebestandig <i>Conditional oil resistant</i></p>
<p>30.2151</p>  <p>Skørteprofil Skirt profile Hardness: PVC, <i>white</i> Rulle med <i>Roll of 14 m</i> Min. order: 560 m</p>	<p>30.6648 / 30.6648G / 30.6648S</p>  <p>Skørteprofil Skirt profile Hardness: SH 75 30.6648: EPDM black 30.6648G *: TPE <i>grey</i> 30.6648S *: TPE black</p>	<p>30.2151S</p>  <p>Material: PVC, black Hardness: SH 75 - 80 Min. order: 280 m</p>	<p>30.2566</p>  <p>Skørteprofil Skirt profile Material: PVC, black Hardness: SH 80 Height: 125 mm Rulle med <i>Roll of 64 m</i></p>

* Skaffevare *Special order item*

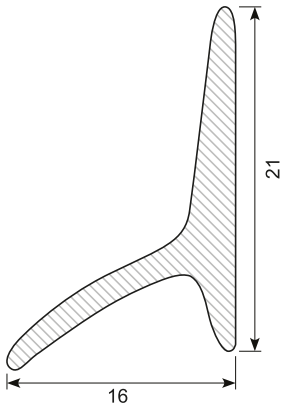
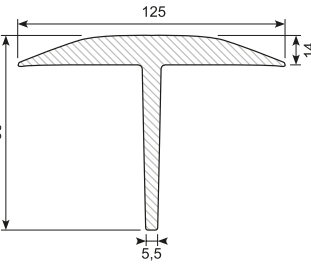
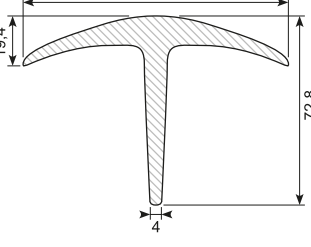
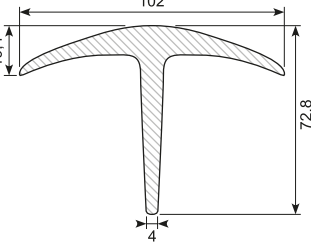
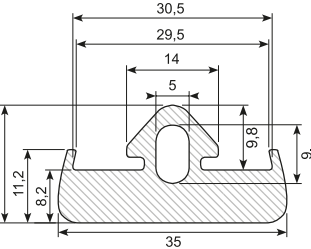
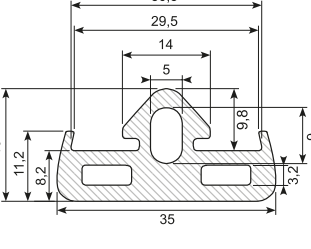
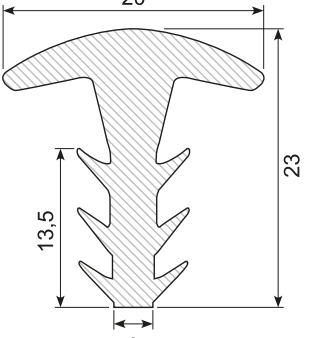
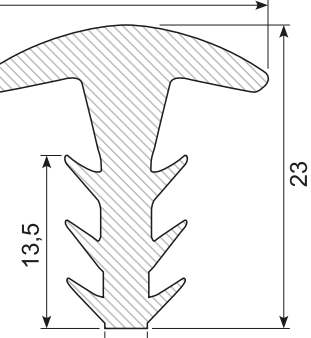
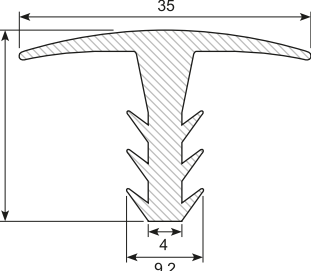
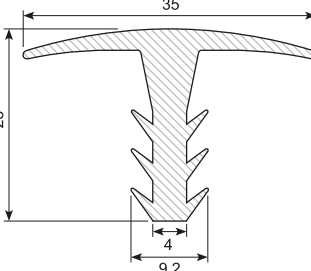
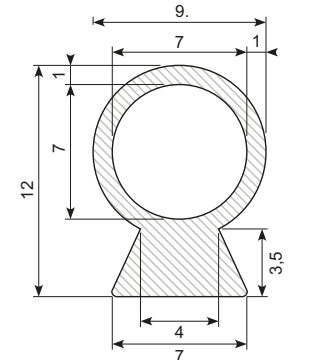
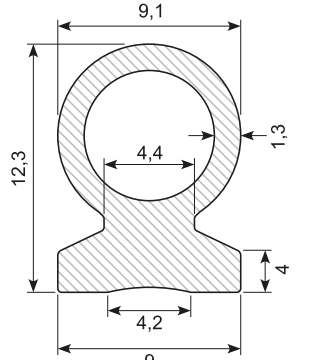
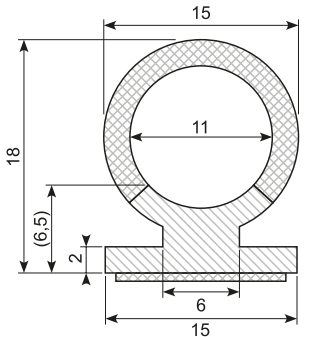
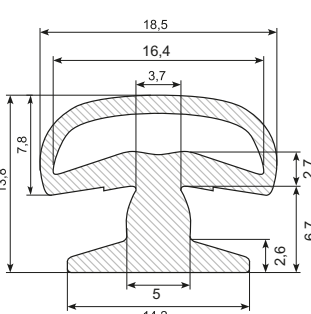
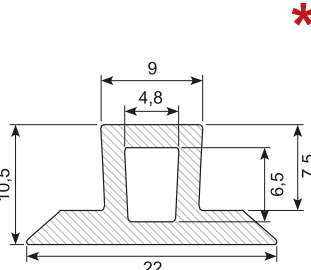
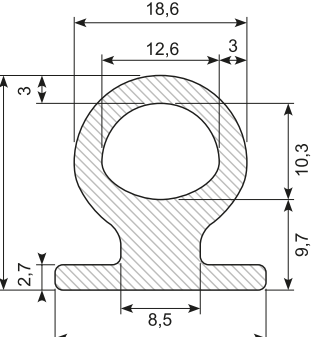
<p>30.257S</p>  <p>Material: EPDM, black Hardness: SH 65</p>	<p>30.7780/4</p>  <p>Material: EPDM, black Hardness: SH 65 Length: 4 m</p>	<p>30.7300 / 30.7300/4</p>  <p>Material: EPDM, black Hardness: SH 65 30.7300: length: 3 m 30.7300/4: length: 4 m</p>	<p>30.7300/4Y *</p>  <p>Material: EPDM, yellow Hardness: SH 65 Min. order: 64 m</p>
<p>30.6944 *</p>  <p>Material: EPDM, black Hardness: SH 65 Min. order: 200 m</p>	<p>30.5550M</p>  <p>Material: EPDM, black Hardness: SH 65</p>	<p>30.2653 *</p>  <p>Material: EPDM, black Hardness: SH 65 Min. order: 1.000 m</p>	<p>30.5981</p>  <p>Material: EPDM, black Hardness: SH 65</p>
<p>30.8199</p>  <p>Material: EPDM, black Hardness: SH 65 Length: 4 m</p>	<p>30.8199W *</p>  <p>Material: EPDM, white Hardness: SH 65 Length: 4 m Min. order: 223 m</p>	<p>30.314S</p>  <p>Gummiprofil Rubber profile Material: EPDM Hardness: SH 60 / 65</p>	<p>30.7651</p>  <p>Ballonprofil Balloon profile Material: EPDM Hardness: SH 65</p>
<p>30.313</p>  <p>Co-ex profile Material: EPDM / sponge rubber Hardness: SH 80 Med klæb With adhesive</p>	<p>30.7648</p>  <p>Material: EPDM, black Hardness: SH 65</p>	<p>30.7106 *</p>  <p>Material: EPDM, black Hardness: SH 65 Min. order: 1.000 m</p>	<p>30.315S</p>  <p>Material: EPDM, black Hardness: SH 65 Length: 10 m</p>

* Skaffevare Special order item

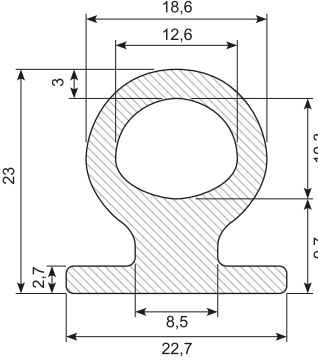
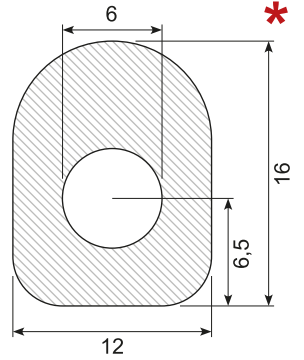
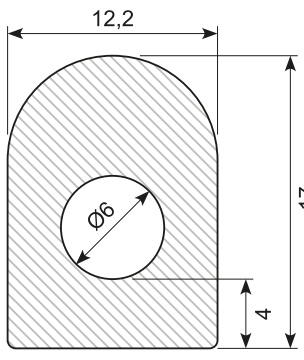
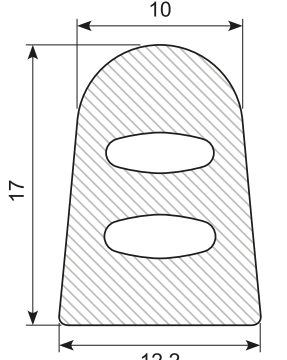
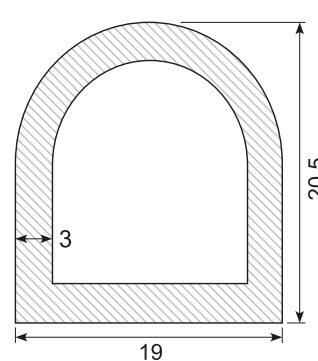
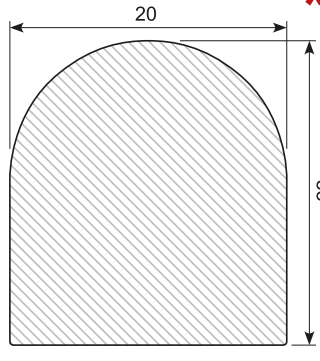
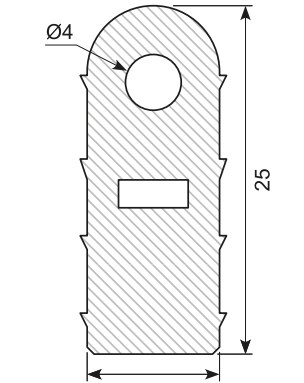
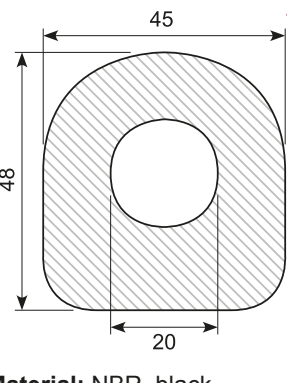
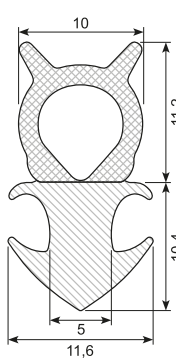
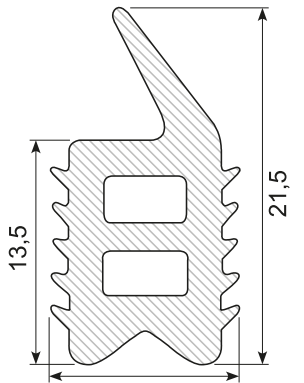
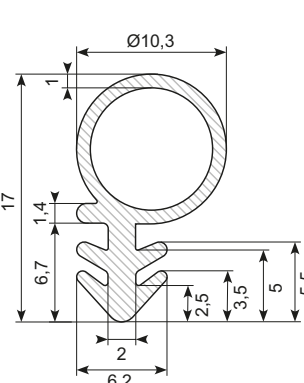
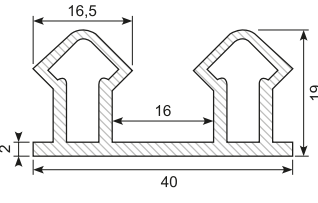
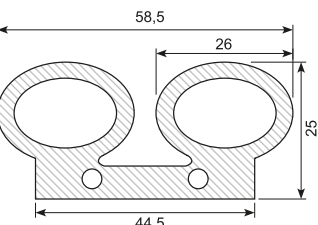
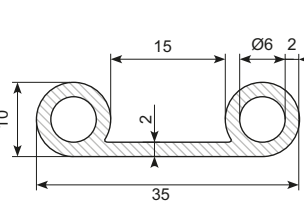
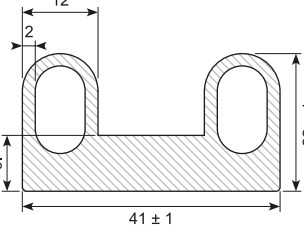
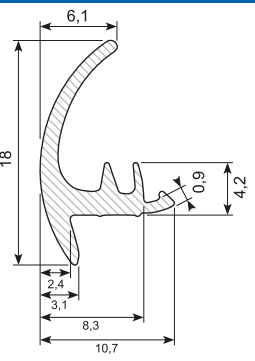
<p>30.315SB</p>  <p>Material: EPDM, black Hardness: SH 45 Length: 10 m</p>	<p>30.50967 *</p>  <p>Material: NBR, black Hardness: SH 65 Olieb Bestandig Oil resistant Min. order: 500 m</p>	<p>30.13841</p>  <p>Material: NBR, black Hardness: SH 45 Olieb Bestandig Oil resistant</p>	<p>30.14053</p>  <p>Material: NBR, black Hardness: SH 50 Olieb Bestandig Oil resistant</p>
<p>30.OT3354</p>  <p>Material: Silicone, white Hardness: SH 60</p>	<p>30.7645 *</p>  <p>Material: EPDM, black Hardness: SH 45 Min. order: 50 m</p>	<p>30.13421</p>  <p>Material: EPDM Hardness: SH 65</p>	<p>30.7559 *</p>  <p>Material: NBR, black Hardness: SH 60 Olieb Bestandig Oil resistant Min. order: 30 m</p>
<p>30.14130</p>  <p>Co-ex profile Material: EPDM Hardness: SH 70 Density: 85 - 95</p>	<p>30.190</p>  <p>Material: PVC Hardness: SH 57</p>	<p>30.OT10644</p>  <p>Material: Silicone, light grey Ø10 mm balloon</p>	<p>30.OT1387 *</p>  <p>Material: Silicone, grey Hardness: SH 60 Min. order: 40 m</p>
<p>30.OT3272 *</p>  <p>Material: Silicone, blue Hardness: SH 60 Min. order: 50 m</p>	<p>30.1428 *</p>  <p>Material: Silicone, red/brown Hardness: SH 60</p>	<p>30.15170</p>  <p>Material: PVC, black Hardness: SH 72</p>	<p>32.8518 *</p>  <p>Rudeprofil End-stop profile Material: EPDM Hardness: SH 65 Rulle med Roll of 50 m</p>

* Skaffevare Special order item

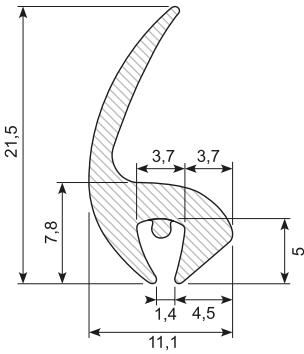
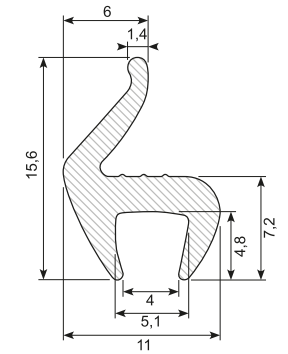
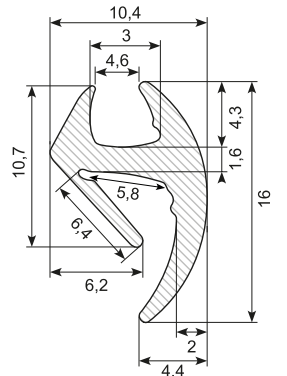
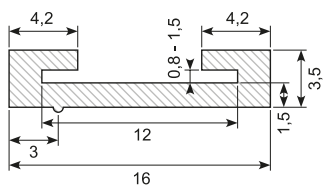
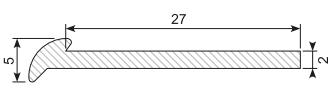
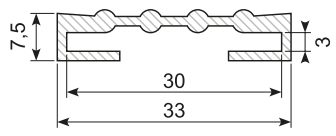
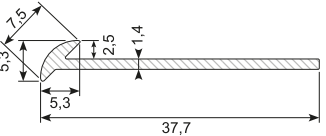
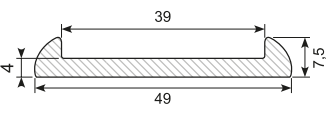
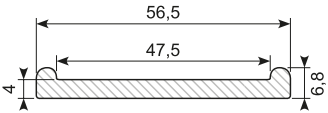
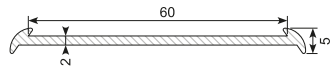
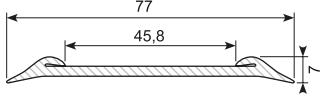
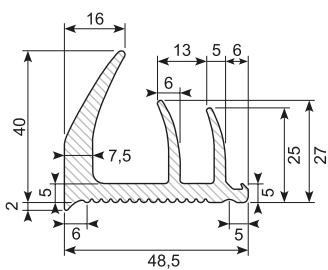
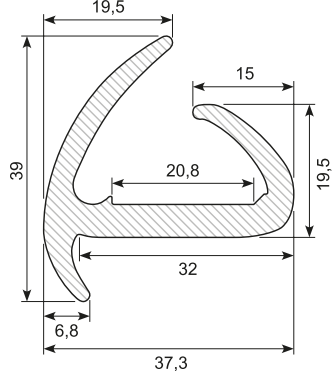
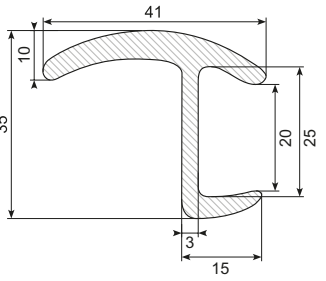
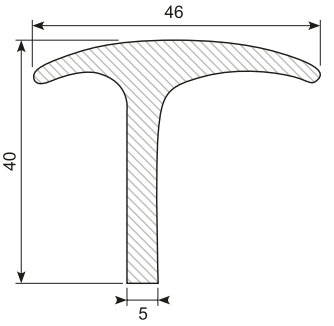
<p>32.8517</p>  <p>Rudeprofil End-stop profile Material: EPDM Hardness: SH 65 Rulle med Roll of 50 m</p>	<p>32.8520</p>  <p>Rudeprofil End-stop profile Material: EPDM Hardness: SH 65 Rulle med Roll of 50 m</p>	<p>31.369</p>  <p>Rudeprofil End-stop profile Material: EPDM, black Hardness: SH 65</p>	<p>30.798</p>  <p>Material: EPDM, black Hardness: SH 65</p>
<p>30.14163-1</p>  <p>Material: EPDM Hardness: SH 65</p>	<p>30.144</p>  <p>Material: EPDM, black Hardness: SH 60</p>	<p>30.5179</p>  <p>Material: EPDM</p>	<p>30.141</p>  <p>Material: EPDM Hardness: SH 60</p>
<p>30.142S</p>  <p>Material: EPDM, black Hardness: SH 65</p>	<p>30.14163</p>  <p>Material: EPDM Hardness: SH 65</p>		<p>30.145</p>  <p>Material: EPDM, black Hardness: SH 70 Min. order: 200 m</p>
<p>30.13447-8</p>  <p>Container profile Material: EPDM Hardness: SH 70 Length: 2,5 m Min. order: 500 m</p>	<p>30.7663</p>  <p>Material: EPDM, black Hardness: SH 65 Length: 5 m</p>	<p>30.340</p>  <p>Material: EPDM, black Hardness: SH 50 Length: 3 m</p>	<p>30.2438</p>  <p>Material: EPDM, black Hardness: SH 65 Length: 2,2 m</p>

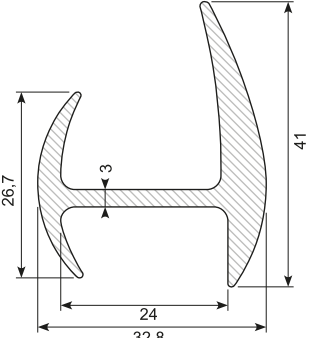
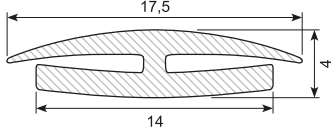
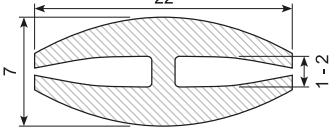
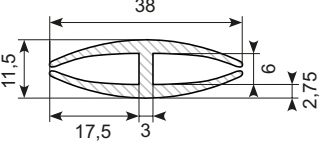
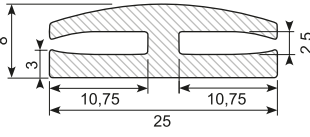
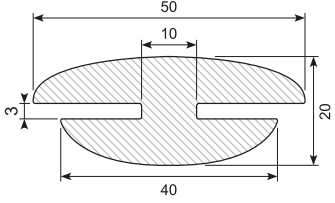
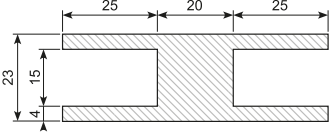
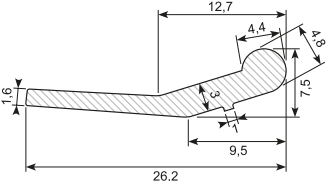
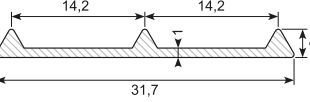
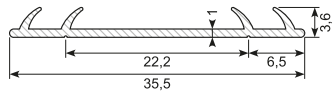
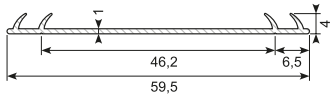
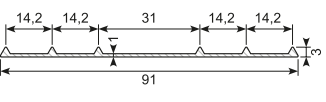
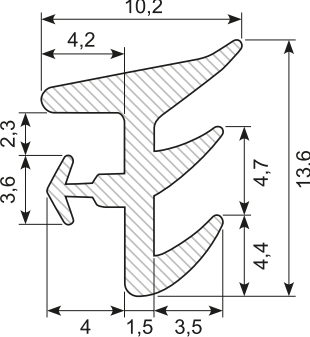
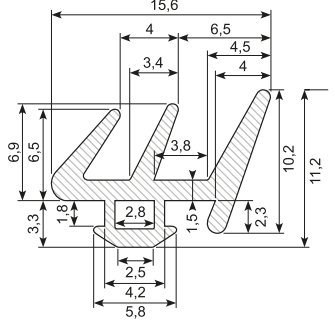
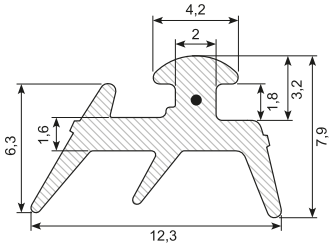
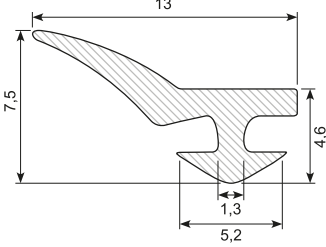
<p>30.4437 *</p>  <p>Material: EPDM, black Hardness: SH 60 Min. order: 85 m</p>	<p>30.7411</p>  <p>Material: EPDM, black Hardness: SH 65 Grip range: 1 - 1,5 mm</p>	<p>34.7528-2 *</p>  <p>Material: PVC, grey Min. order: 1.000 m</p>	<p>30.21202300 *</p>  <p>Material: EPDM Hardness: SH 70A For 6 mm glasplade Min. order: 50 m</p>
<p>30.762</p>  <p>Material: EPDM, black Hardness: SH 65</p>	<p>30.7266 *</p>  <p>Material: EPDM, black Hardness: SH 65 Min. order: 50 m</p>	<p>30.12932-2 *</p>  <p>Material: EPDM, black Hardness: SH 60 Min. order: 400 m</p>	<p>30.16688</p>  <p>Material: EPDM Hardness: SH 70</p>
<p>30.13049-4</p>  <p>Material: EPDM, black Hardness: SH 60</p>	<p>30.13049-2 *</p>  <p>Material: EPDM Hardness: SH 60 Min. order: 5.000 m</p>	<p>30.13049-1 *</p>  <p>Material: EPDM Hardness: SH 60 Min. order: 4.000 m</p>	<p>30.13049-5</p>  <p>Material: EPDM, black Hardness: SH 60</p>
<p>30.4469</p>  <p>Material: EPDM Hardness: SH 60 Silikoniseret <i>Coated with silicone</i></p>	<p>30.10485</p>  <p>Material: EPDM Silikoniseret <i>Coated with silicone</i></p>	<p>30.9387-2 *</p>  <p>Material: EPDM Med indvendig snor <i>With internal cord</i> Min. order: 5.000 m</p>	<p>31.702 *</p>  <p>Material: EPDM, black Hardness: SH 70 Min. order: 2.000 m</p>

* Skaffevare Special order item

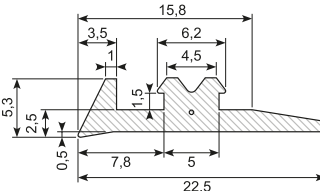
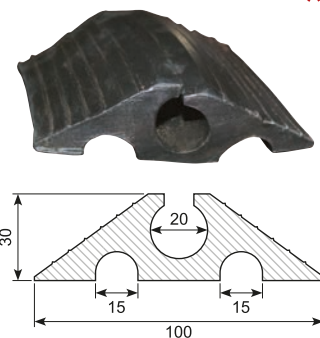
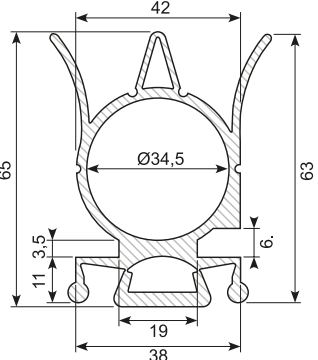
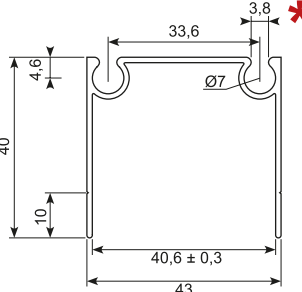
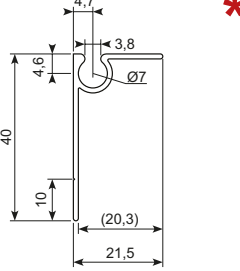
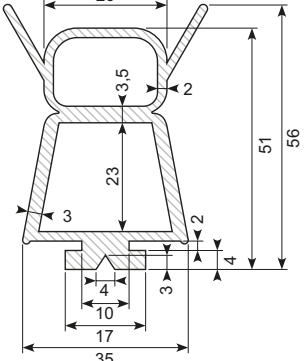
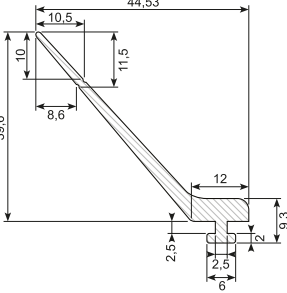
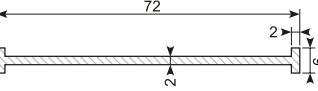
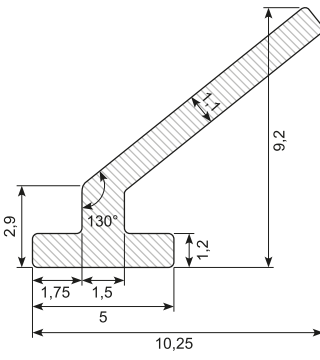
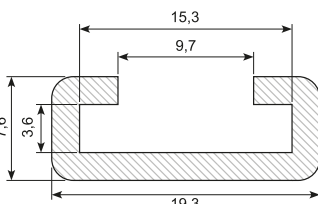
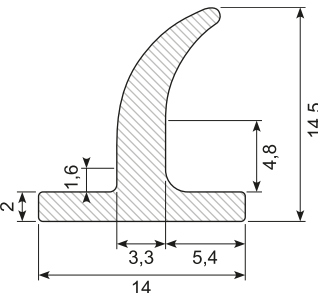
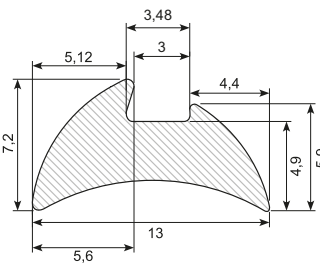
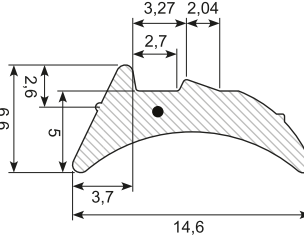
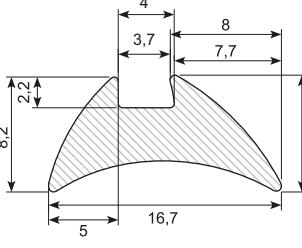
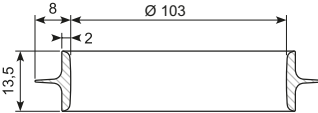
<p>30.10461-2 *</p>  <p>Profil med fod og indvendig snor. Profile with foot and internal cord. Material: EPDM, with cord Min. order: 3.000 m</p>	<p>52.PP106 *</p>  <p>Kabel overkørsel Cable transmission Material: NR / SBR Rulle med Roll of 9 m</p>	<p>30.13503</p>  <p>Material: EPDM, black Hardness: SH 60 For skinne For rail: 41.13459</p>	<p>41.13459 *</p>  <p>Aluprofil for port, eloxeret overflade. Aluprofile for gate, anodized surface. Length: 6 m Calculated weight: 479 g/m For profile: 30.13503</p>
<p>41.13459X *</p>  <p>Aluprofil for port, eloxeret overflade. Aluprofile for gate, anodized surface. Length: 6 m Calculated weight: 239 g/m For profile: 30.13503 Min. order: 50 pcs. + add on costs</p>	<p>30.9215</p>  <p>Material: EPDM Hardness: SH 65 - 70</p>	<p>30.9826-1</p>  <p>Material: EPDM Hardness: SH 70</p>	<p>30.9826-2</p>  <p>Material: EPDM Hardness: SH 70</p>
<p>30.10036</p>  <p>Material: EPDM Hardness: SH 70</p>		<p>41.670</p>  <p>Eloxeret aluminium 3 m med montagehuller. Ø4 hver 200 mm. For profile 30.13242</p>	<p>30.16239</p>  <p>Material: EPDM Hardness: SH 70</p>
<p>30.9996-5</p>  <p>Material: EPDM Hardness: SH 70</p>	<p>30.9387-1</p>  <p>Material: EPDM Hardness: SH 70 Med indvendig snor With internal cord</p>	<p>30.9996-4</p>  <p>Material: EPDM Hardness: SH 70</p>	<p>30.9437-125</p>  <p>Ventilation ring Material: EPDM, black Hardness: SH 60 - 65</p>

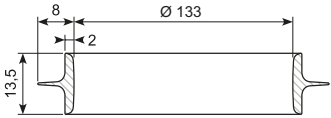
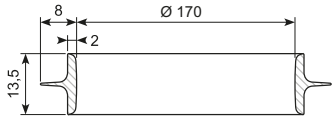
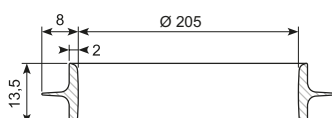
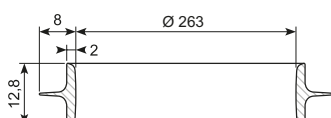
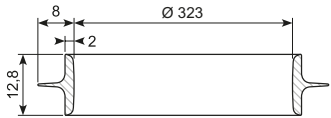
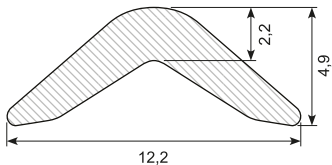
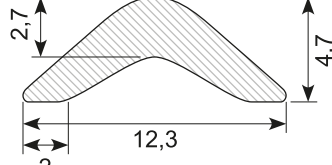
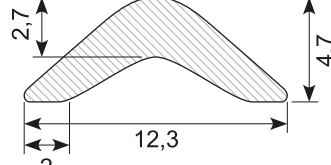
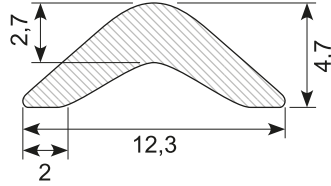
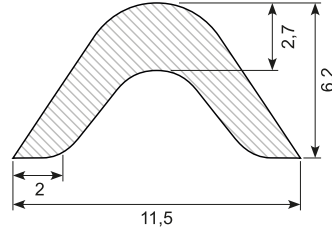
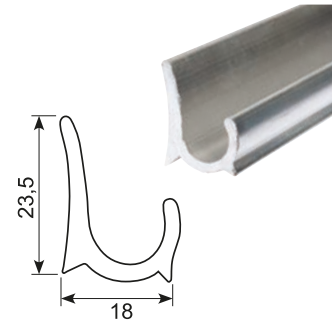
30.9437-160	30.9437-200	30.9437-250	30.9437-315
 <p>Ventilation ring Material: EPDM, black Hardness: SH 60 - 65</p>	 <p>Ventilation ring Material: EPDM, black Hardness: SH 60 - 65</p>	 <p>Ventilation ring Material: EPDM, black Hardness: SH 60 - 65</p>	 <p>Ventilation ring Material: EPDM, black Hardness: SH 60 - 65</p>
30.9437-400	45.205SX	45.209BX	45.210BX
 <p>Ventilation ring Material: EPDM, black Hardness: SH 60 - 65</p>	 <p>Material: PVC, silver grey Min. order: 3.000 m</p>	 <p>Material: PVC, black</p>	 <p>Material: PVC, white</p>
45.210C / 45.210CX	45.208	41.406	
 <p>Material: PVC, off white</p>	 <p>Material: PVC, blue</p>	 <p>Vandrende, upoleret <i>Water gutter, unpolished</i> Size: 17 x 24 Length: 5 m</p>	

Silikoneprofiler (skaffevarer)

Silicone profiles (special order items)







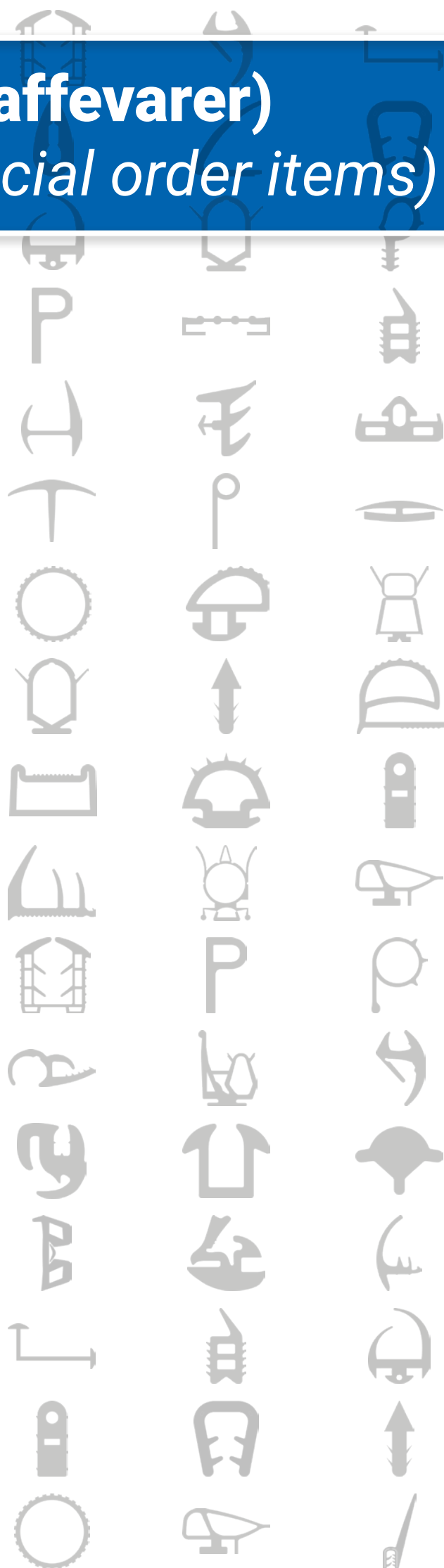

Her kan du finde et udvalg af de silikoneprofiler, som vi kan skaffe på bestilling. Vi har meget mere udvalg end der bliver vist i dette katalog, så kontakt os gerne, hvis du ikke finder det rette.

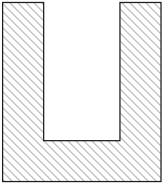
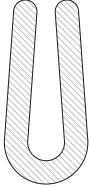
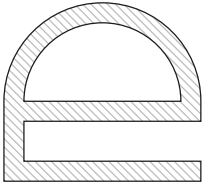
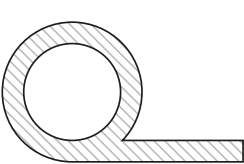
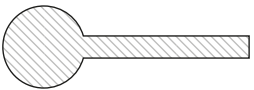
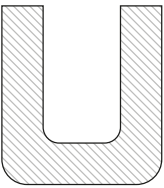
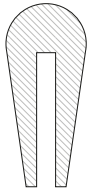
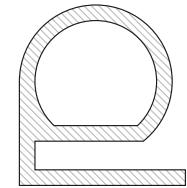
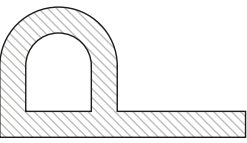
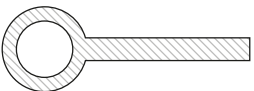
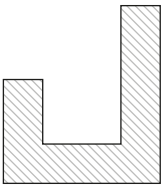
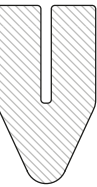
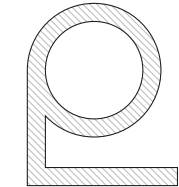
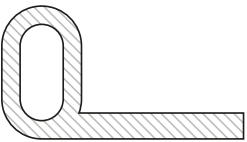
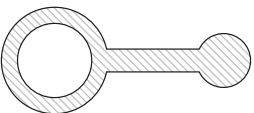
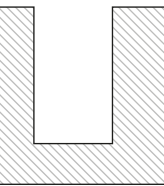

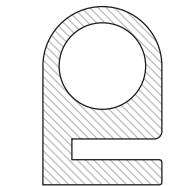
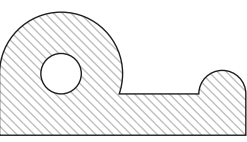

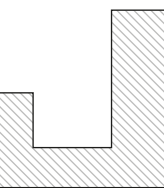
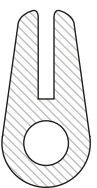
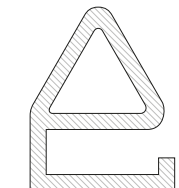
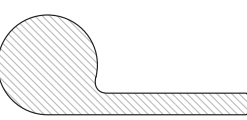
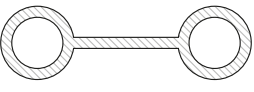
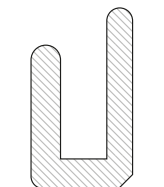
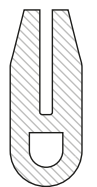
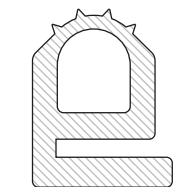
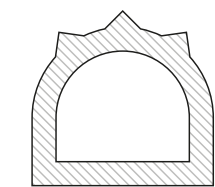
Here you can find a selection of the silicone profiles we can provide on order.

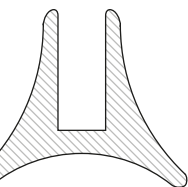

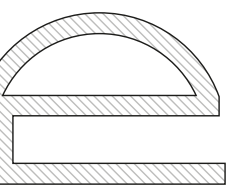
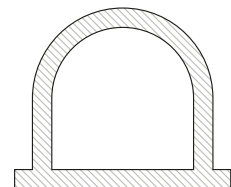
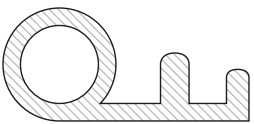
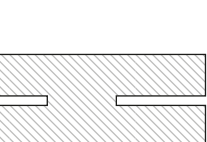
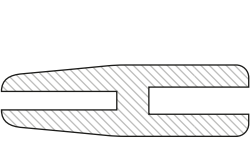
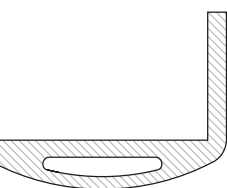
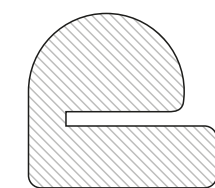
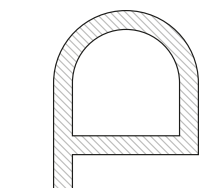

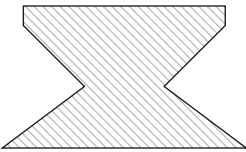
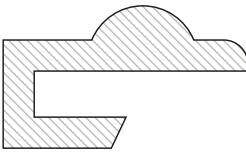
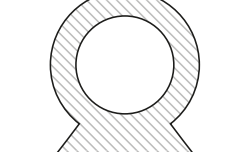
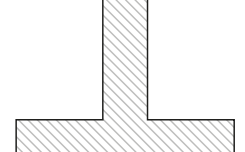
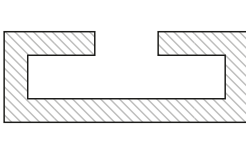
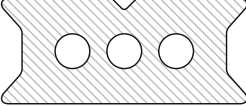
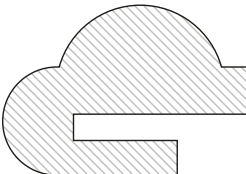
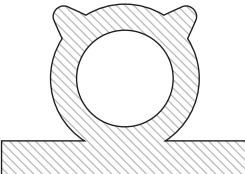
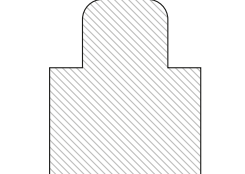
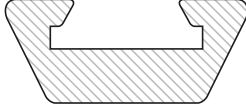
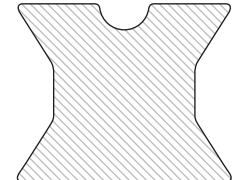
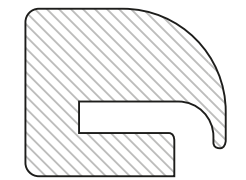
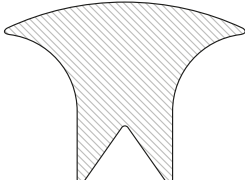
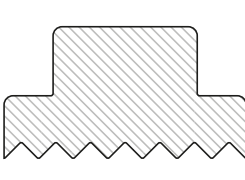
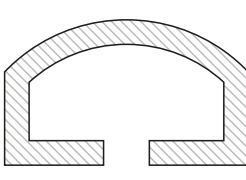
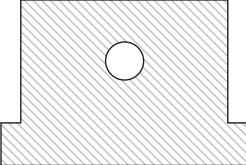

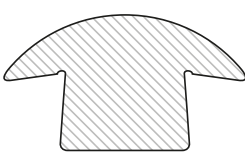
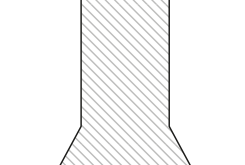
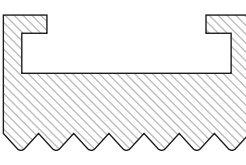
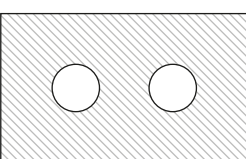
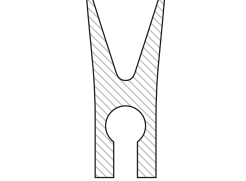
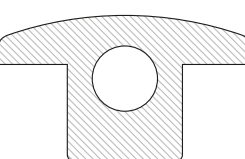

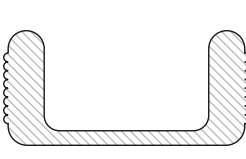
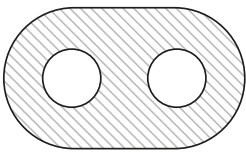
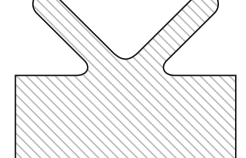
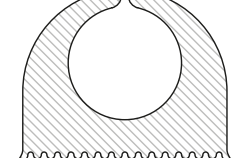
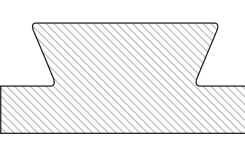
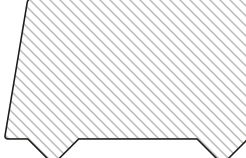
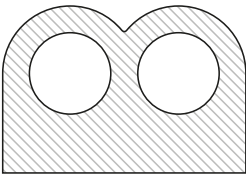
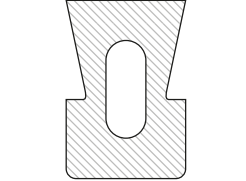
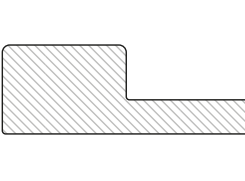
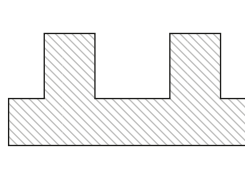
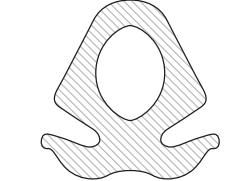
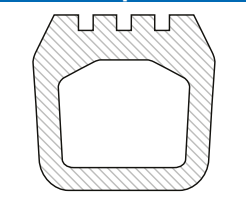
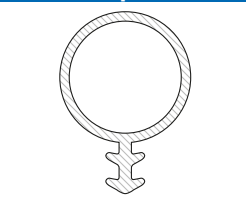
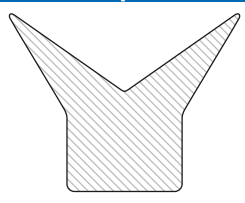
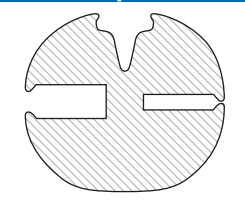
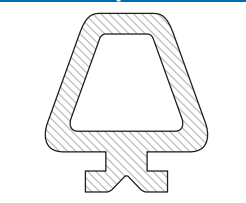
We have a much wider selection than shown in this catalog, so please contact us if you can't find what you're looking for.

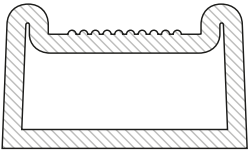
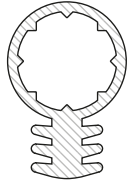
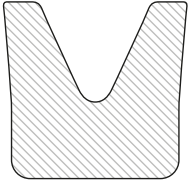
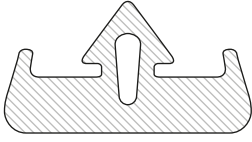
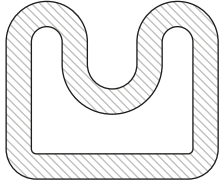
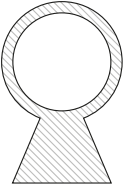
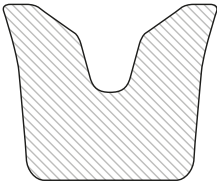
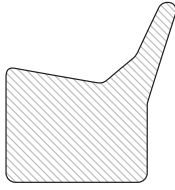
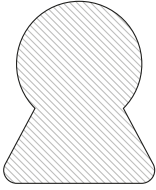
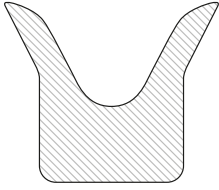
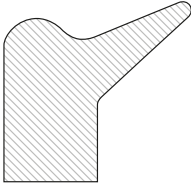

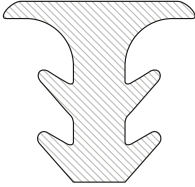
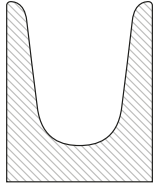
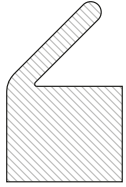
Group 0010	Group 0021	Group 0023	Group 0107	Group 0030
Group 0011	Group 0175	Group 0201	Group 0106	Group 0120
Group 0012	Group 0022	Group 0024	Group 0209	Group 0124
Group 0020	Group 0101	Group 0025	Group 0111	Group 0126
Group 0121	Group 0100	Group 0109	Group 0110	Group 0125
Group 0139	Group 0108	Group 0153	Group 0112	Group 0160
Group 0150	Group 0186	Group 0169	Group 0192	Group 0159
Group 0178	Group 0113	Group 0208	Group 0214	Group 0119

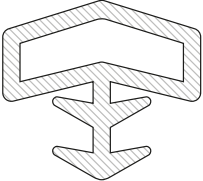
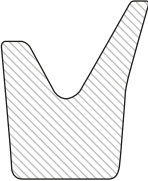
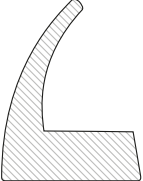
Group 0102 	Group 0104 	Group 0129 	Group 0127 	Group 0171 
Group 0517 	Group 0145 	Group 0130 	Group 0191 	Group 0516 
Group 0102A 	Group 0179 	Group 0131 	Group 0206 	Group 0144 
Group 0103 	Group 0105 	Group 0132 	Group 0134 	Group 0194 
Group 0103A 	Group 0172 	Group 0133 	Group 0211 	Group 0147 
Group 0146 	Group 0188 	Group 0181 	Group 0167 	Group 0128 
Group 0199 	Group 0158 	Group 0170 	Group 0140 	Group 0137 
Group 0155 	Group 0141 	Group 0207 	Group 0508 	Group 0148 

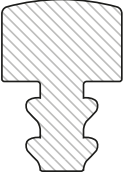
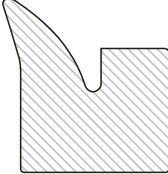
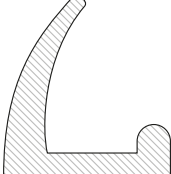
Group 0122	Group 0176	Group 0177	Group 0143	Group 0164
				
Group 0123	Group 0197	Group 0165	Group 0117	Group 0166
				
Group 0157	Group 0173	Group 0182	Group 0187	Group 0138
				
Group 0151	Group 0189	Group 0190	Group 0115	Group 0196
				
Group 0200	Group 0152	Group 0215	Group 0210	Group 0205
				
Group 0180	Group 0168	Group 0198	Group 0213	Group 0163
				
Group 0156	Group 0142	Group 0154	Group 0512	Group 0193
				
Group 0183	Group 0202	Group 0116	Group 0510	Group 0193
				

Group 0514	Group 0195	Group 0501	Group 0174	Group 0507
				
Group 0203	Group 0502	Group 0184	Group 0212	Group 0503
				
Group 0184	Group 0118	Group 0185	Group 0504	Group 0513
				
Group 0161	Group 0204	Group 0505	Group 0136	Group 0515
				
Group 0511	Group 0506	Group 0135	Group 0509	
				

Co-ekstruderede plastprofiler

Co-extruded plastic profiles

Co-ekstruderede plastprofiler anvendes som dørtætningslister. Profilerne består af to dele. Den ene del er hård og monteres på sandwich-delen, og den anden del (læberne) er blød. Dermed får man en optimal tætning.

Co-extruded plastic profiles are used as door sealing trims. The profiles consist of two parts. One part is hard and is mounted on the sandwich-part and the other part (the lips) are soft. This gives an optimal seal.

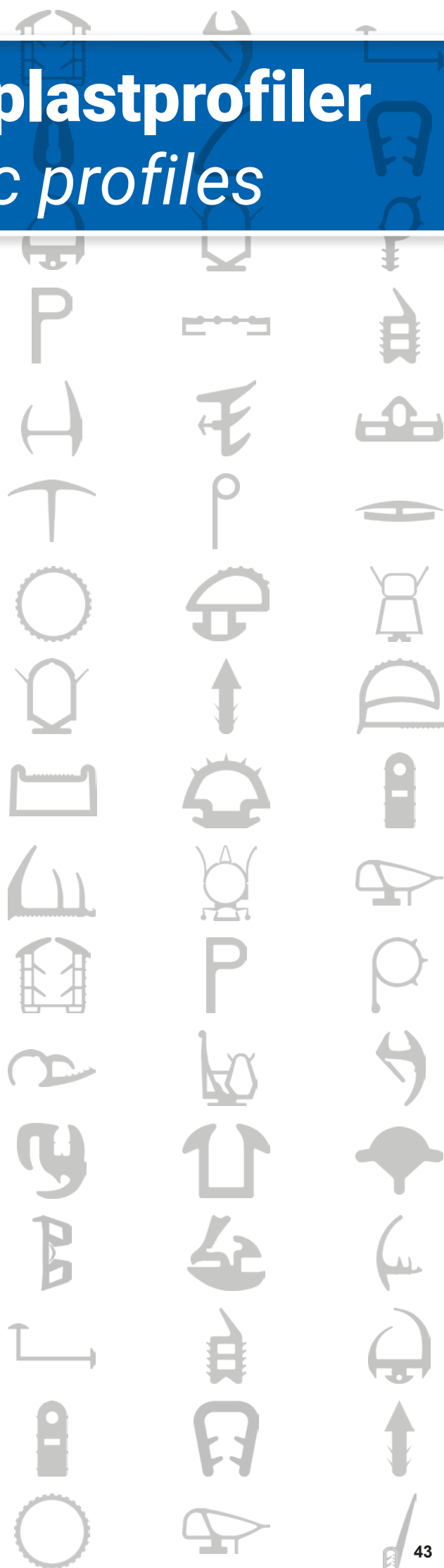

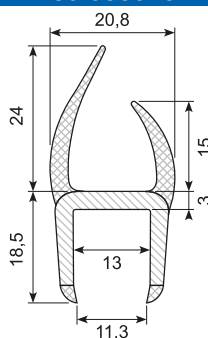
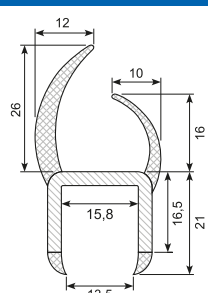
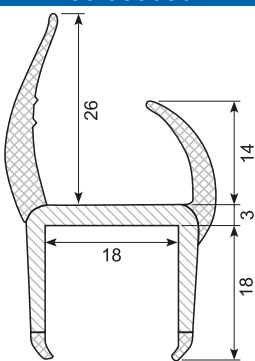
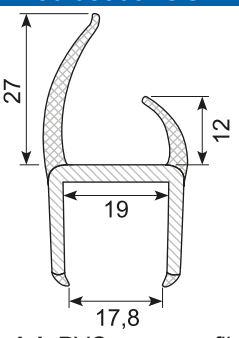
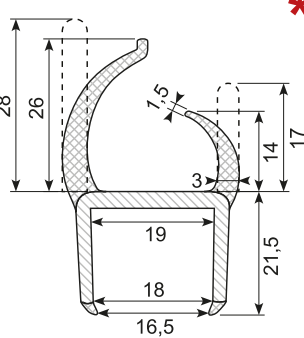
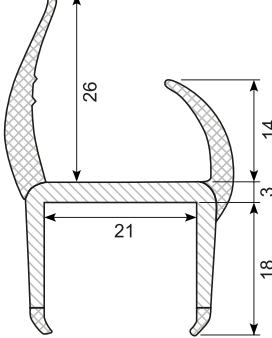
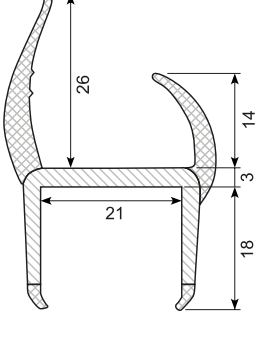
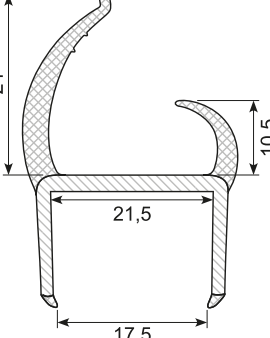
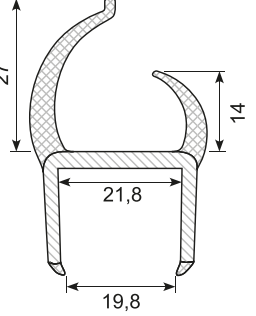
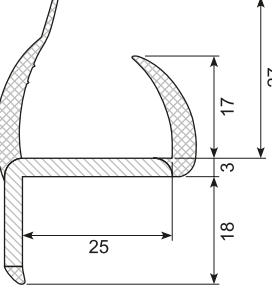
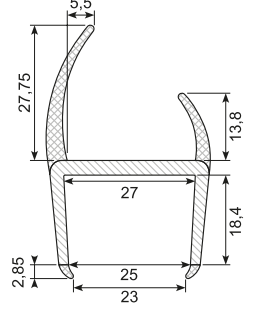
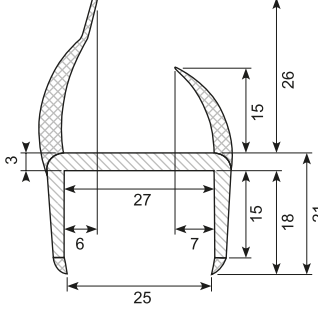
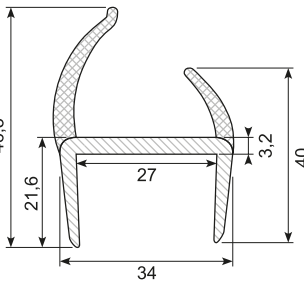
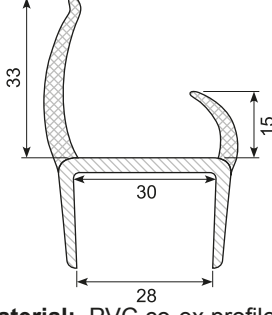
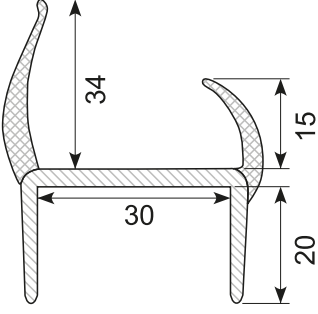
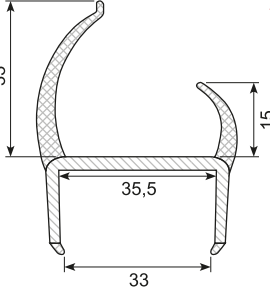
<p>50.083013</p>  <p>Material: PVC co-ex profile, 13 mm, black / white lips Length: 5 m 4 bløde læber 4 soft lips Min. order: 1.000 m</p>	<p>50.083015GG * / 50.083015GGX</p>  <p>Material: PVC co-ex profile, 15 mm, grey / light grey lips Length: 5 m / 4 m 4 bløde læber 4 soft lips 50.083015GGX: light grey / light grey lips 50.083015GG: Min. order: 2.400 m</p>	<p>50.083030</p>  <p>Material: PVC co-ex profile, 18 mm, white / black lips Length: 5 m 4 bløde læber 4 soft lips</p>	<p>50.083032GG</p>  <p>Material: PVC co-ex profile, 18,4 mm, grey / grey lips Length: 6 m 4 bløde læber 4 soft lips Kan fås i andre farver <i>Available in other colors</i></p>
<p>50.083033 *</p>  <p>Material: PVC co-ex profile, 19 mm, light grey / black lips Length: 5 m 4 bløde læber 4 soft lips Min. order: 2.500 m</p>	<p>50.083040GS</p>  <p>Material: PVC co-ex profile, 21 mm, black / grey lips Length: 6 m 4 bløde læber 4 soft lips</p>	<p>50.083040</p>  <p>Material: PVC co-ex profile, 21 mm, black / white lips Length: 5 m 4 bløde læber 4 soft lips Min. order: 200 m</p>	<p>50.083040G</p>  <p>Material: PVC co-ex profile, 21 mm, grey / grey lips Length: 5 m 4 bløde læber 4 soft lips</p>
<p>50.083040GG *</p>  <p>Material: PVC co-ex profile, 20,8 mm, grey / grey lips Length: 6 m 4 bløde læber 4 soft lips Kan fås i andre farver <i>Available in other colors</i></p>	<p>50.083045X *</p>  <p>Material: PVC co-ex profile, 25 mm Length: 5 m 3 bløde læber 3 soft lips Kan fås i andre farver <i>Available in other colors</i> Min. order: 250 m (China)</p>	<p>54.710720 *</p>  <p>Material: PVC co-ex profile, 25 mm Hardness: Hard/soft Length: 3 m 4 bløde læber 4 soft lips Min. order: 25 m</p>	<p>50.083045G</p>  <p>Material: PVC co-ex profile, 25 mm Length: 6 m 4 bløde læber 4 soft lips Kan fås i andre farver <i>Available in other colors</i></p>
<p>50.083046 *</p>  <p>Material: Co-ex profile, 27 mm light grey / light grey lips Length: 5 m 2 bløde læber 2 soft lips Min. order: 500 m</p>	<p>50.083050GG *</p>  <p>Material: PVC co-ex profile, 30 mm, grey / grey lips Length: 5 m 2 bløde læber 2 soft lips Kan fås i andre farver <i>Available in other colors</i> Min. order: 500 m</p>	<p>50.083050</p>  <p>Material: PVC co-ex profile, 30 mm, black / white lips Length: 5 m 2 bløde læber 2 soft lips</p>	<p>50.083052G *</p>  <p>Material: PVC co-ex profile, 35 mm, grey / grey lips Length: 3 m 4 bløde læber 4 soft lips Kan fås i andre farver <i>Available in other colors</i> Min. order: 300 m</p>

* Skaffevare Special order item

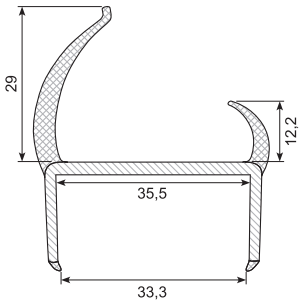
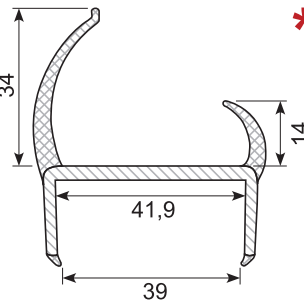
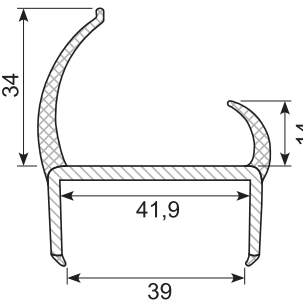
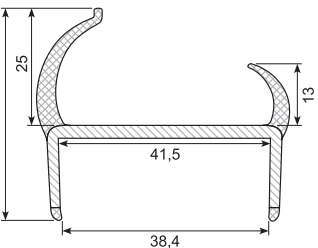
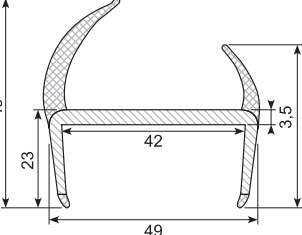
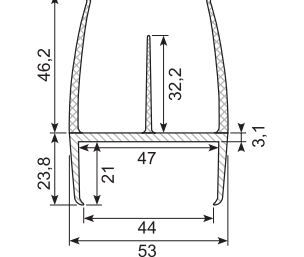
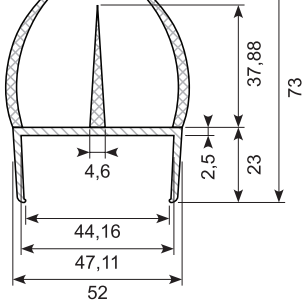
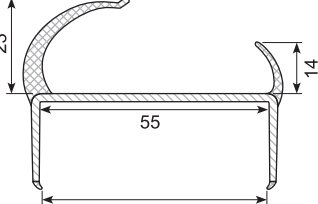
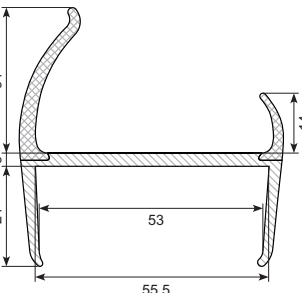
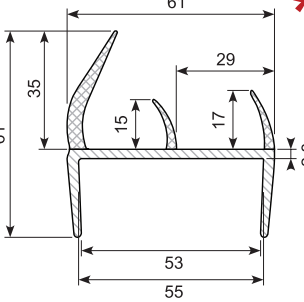
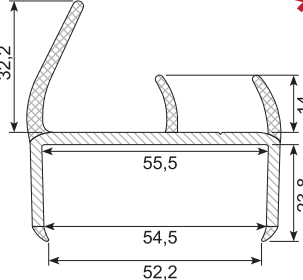
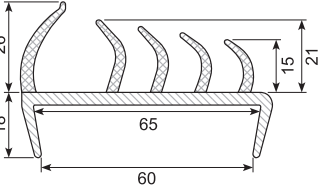
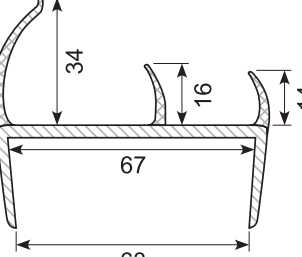
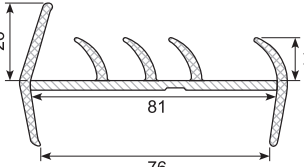
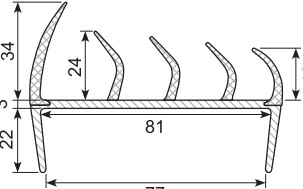
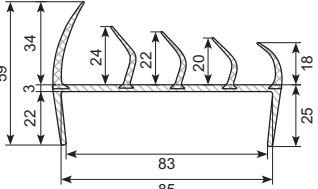
<p>50.083055G</p>  <p>Material: PVC co-ex profile, 35 mm, light grey / grey lips Length: 5 m 4 bløde læber 4 soft lips</p>	<p>50.083060 *</p>  <p>Material: PVC co-ex profile, 40 mm, white / black lips Length: 5 m 4 bløde læber 4 soft lips Kan fås i andre farver Available in other colors Min. order: 500 m</p>	<p>50.083060GG</p>  <p>Material: PVC co-ex profile, 40 mm, Grey/Grey lips Length: 5 m 4 bløde læber 4 soft lips</p>	<p>50.083060G</p>  <p>Material: PVC co-ex profile, 40 mm, light grey / grey lips Length: 5 m 2 bløde læber 2 soft lips Udgår! not available</p>
<p>50.083061 *</p>  <p>Material: PVC co-ex profile, 42 mm, white / black lips Length: 5 m 4 bløde læber 4 soft lips Min. order: 250 m (China)</p>	<p>50.083065 *</p>  <p>Material: PVC co-ex profile, 45 mm, grey / grey lips Length: 5 m 3 bløde læber 3 soft lips Kan fås i andre farver Available in other colors Min. order: 250 m</p>	<p>50.083065G</p>  <p>Material: Co-ex profile, 45 mm, off white / black lips Length: 5 m</p>	<p>50.083070G *</p>  <p>Material: PVC co-ex profile, 55 mm, light grey / grey lips Length: 5 m 4 bløde læber 4 soft lips Min. order: 1.500 m</p>
<p>50.083070GG *</p>  <p>Material: PVC co-ex profile, 55 mm, light grey / grey lips Length: 5 m 4 bløde læber 4 soft lips Min. order: 300 m</p>	<p>50.083070B *</p>  <p>Material: PVC co-ex profile, 55 mm, white / black lips Length: 5 m 4 bløde læber 4 soft lips Min. order: 500 m</p>	<p>54.710770 *</p>  <p>Material: PVC co-ex profile, 30 mm, grey Length: 3 m 4 bløde læber 4 soft lips Min. order: 50 m</p>	<p>50.083081</p>  <p>Material: PVC co-ex profile, 65 mm, black 5 bløde læber 5 soft lips</p>
<p>50.083080G</p>  <p>Material: PVC co-ex profile, 65 mm, grey / grey lips Length: 5 m 2 bløde læber 2 soft lips</p>	<p>50.083088 *</p>  <p>Material: PVC co-ex profile, 81 mm, black / black lips 5 bløde læber 5 soft lips Min. order: 250 m</p>	<p>50.083089</p>  <p>Material: PVC co-ex profile, 81 mm, black / black lips 5 bløde læber 5 soft lips</p>	<p>50.083095BB</p>  <p>Material: PVC, black Length: 5 m Hardness: SH 60 5 bløde læber 5 soft lips</p>

* Skaffevare Special order item

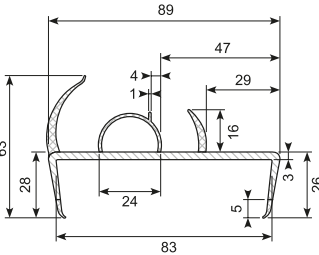
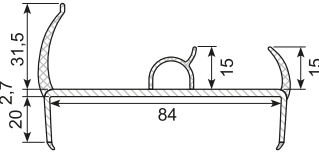
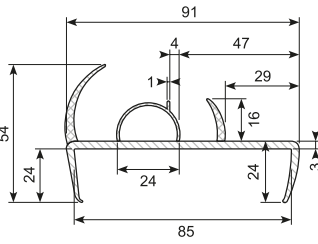
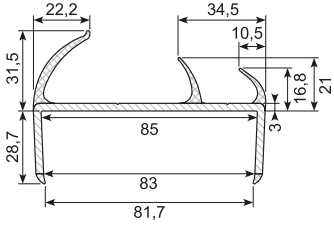
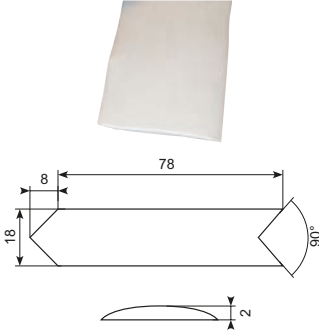
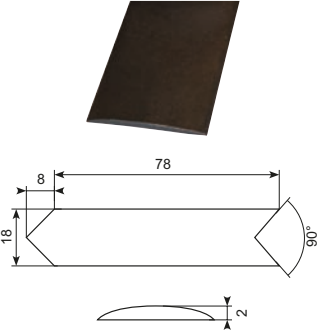
50.083090	50.083095B *	50.083095G *	54.710780 *
 <p>Material: PVC co-ex profile, 83 mm, light grey / light grey lips Length: 5 m 4 bløde læber 4 soft lips</p>	 <p>Material: PVC co-ex profile, 84 mm, white / black lips Length: 5 m 4 bløde læber 4 soft lips Min. order: 500 m</p>	 <p>Material: PVC co-ex profile, 85 mm, white / black lips Length: 5 m 4 bløde læber 4 soft lips Min order: 250 m</p>	 <p>Material: PVC co-ex profile, 85 mm, black / grey lips Hardness: Hard / soft Length: 3 m 4 bløde læber 4 soft lips Min. order: 50 pcs.</p>
50.083000GG	50.083000SS		
 <p>Grå hjørneband, blød PVC. I løbende meter. <i>Grey connection part. Soft PVC. In running meters.</i></p>	 <p>Sort hjørneband, blød PVC. I løbende meter. <i>Grey connection part. Soft PVC. In running meters.</i></p>		

U-profiler

U-profiles



En U-profil er en ren gummiliste uden indlæg. Den fremstilles i flere forskellige størrelser, varianter og materialer som bl.a. EPDM, NR, CR, NBR, SBR og silikonegummi.

U-profiler er fortrinlige til at beskytte paneler, døre, kanter og glas og kan bruges i bl.a. maskiner, biler, møbler osv.

A U-profile is a pure rubber trim without inserts. It is produced in different sizes, variants and materials such as EPDM, NR, CR, NBR, SBR and silicone rubber.

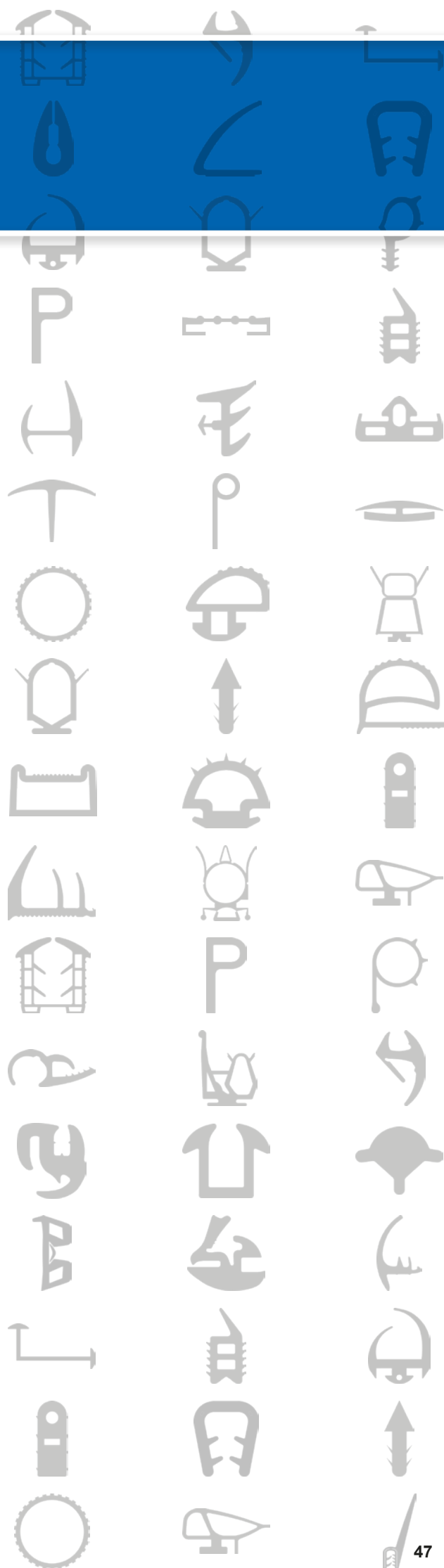
U-profiles are excellent for protecting panels, doors, edges and glass and can be used for machines, cars, furniture, etc.

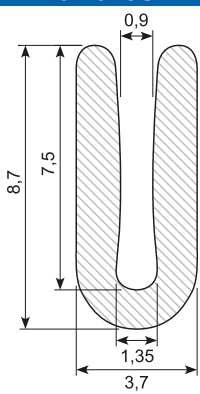
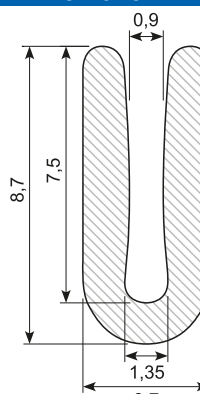
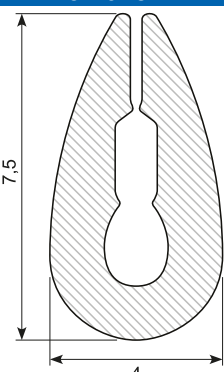
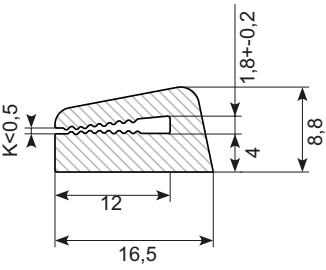
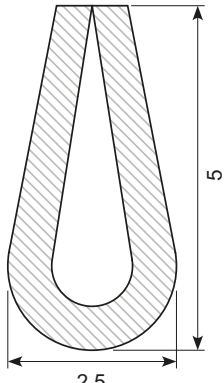
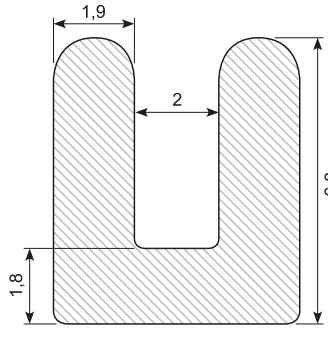
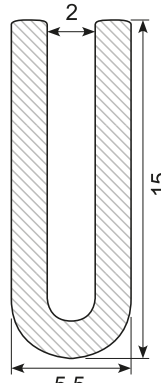

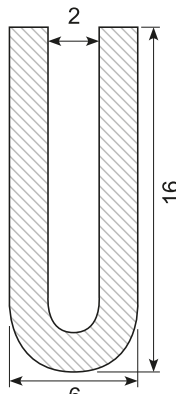
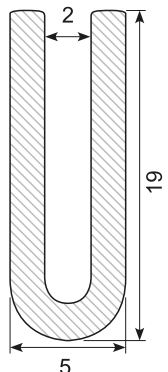
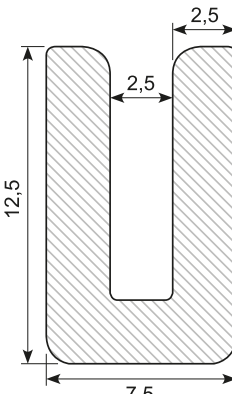
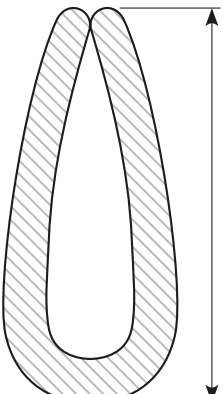
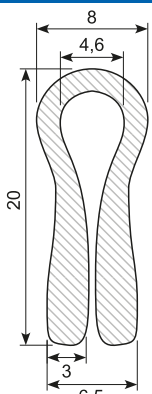
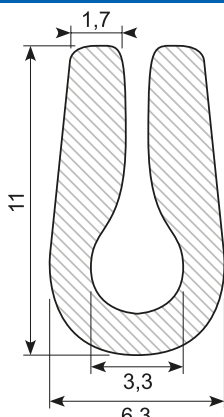
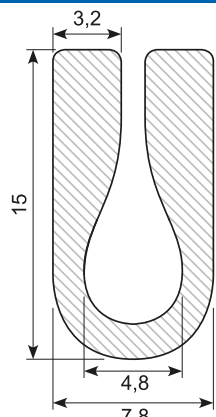
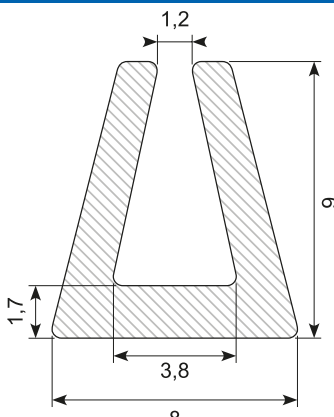
<p>31.018S *</p>  <p>Material: EPDM, black Hardness: SH 65 Min. order: 4.100 m</p>	<p>31.018X</p>  <p>Material: PVC, black Hardness: SH 65</p>	<p>34.018X</p>  <p>Material: PVC, light grey Hardness: Soft Plate: 1 mm</p>	<p>30.11393</p>  <p>Material: Silicone, grey Hardness: SH 50</p>
<p>34.14334X</p>  <p>Material: Hard PVC, black Plate: 1,5 - 2 mm</p>	<p>31.060S</p>  <p>Material: EPDM, black Hardness: SH 65</p>	<p>31.041S</p>  <p>Material: EPDM, black Hardness: SH 65</p>	<p>31.042S</p>  <p>Material: EPDM, black Hardness: SH 65</p>
<p>30.OT3394 *</p>  <p>Material: Silicone, black Min. order: 100 m</p>	<p>31.047 *</p>  <p>Material: EPDM, black Hardness: SH 65 Min. order: 1.000 m</p>	<p>31.063</p>  <p>Material: EPDM, black Hardness: SH 65</p>	<p>30.9548</p>  <p>Material: PVC hard, light grey Length: 3,9 m</p>
<p>31.025S *</p>  <p>Material: EPDM, black Hardness: SH 65 Min. order: 600 m</p>	<p>31.021S</p>  <p>Material: EPDM, black Hardness: SH 65</p>	<p>31.022S</p>  <p>Material: EPDM, black Hardness: SH 65</p>	<p>34.031X</p>  <p>Material: PVC, transparent Hardness: Soft</p>

* Skaffevare Special order item

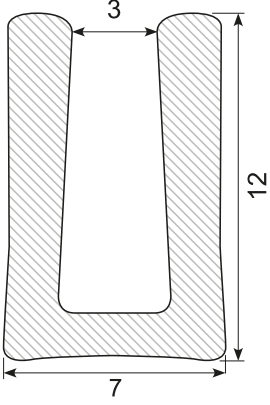
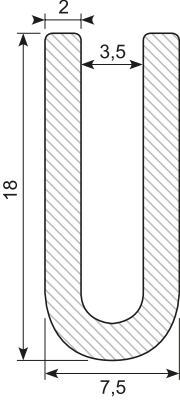
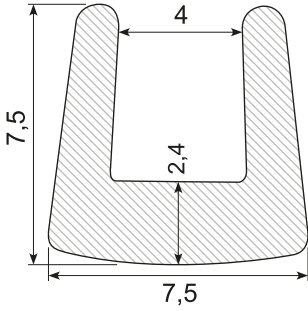
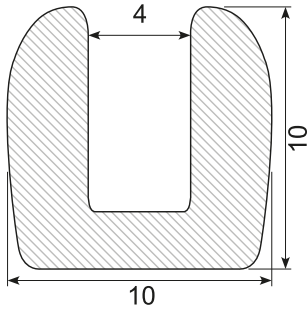
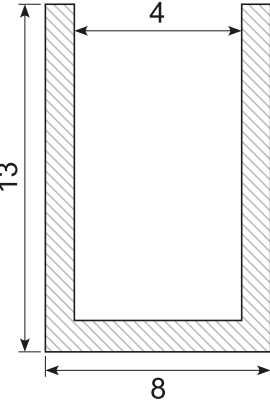
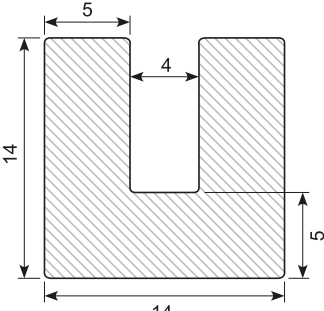
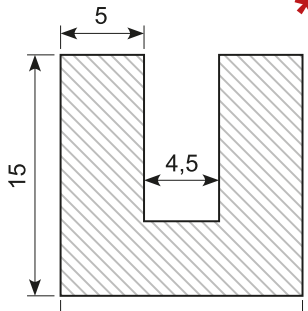
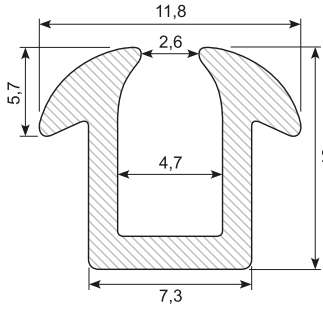
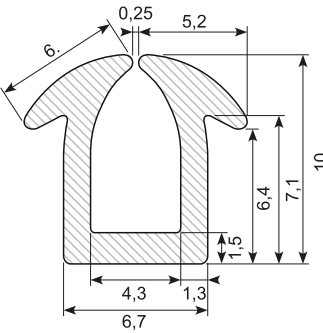
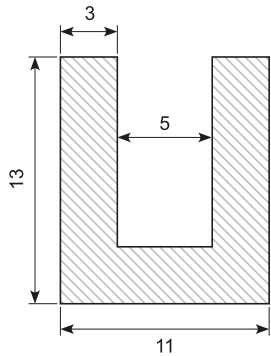
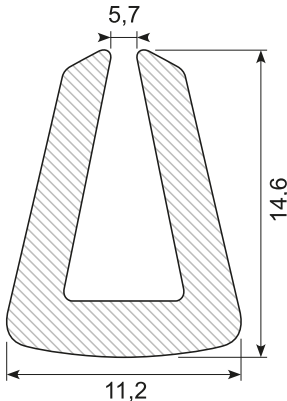
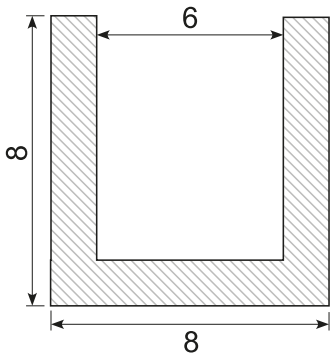
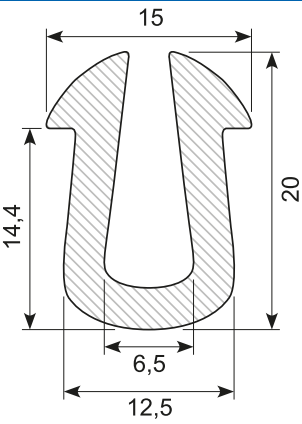
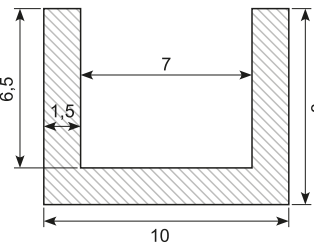
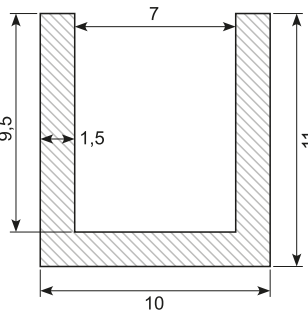
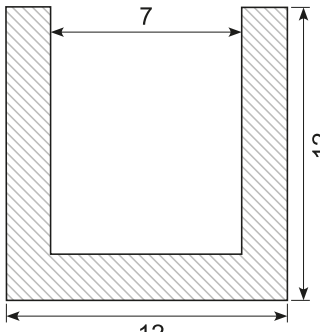
<p>30.13086</p>  <p>Material: EPDM, black Hardness: SH 80</p>	<p>31.043S</p>  <p>Material: EPDM, black Hardness: SH 65</p>	<p>31.064</p>  <p>Material: EPDM, black Hardness: Hard</p>	<p>31.065S</p>  <p>Material: EPDM, black Hardness: SH 65</p>
<p>31.061S</p>  <p>Material: EPDM, black Hardness: SH 65</p>	<p>30.6622N</p>  <p>Material: NBR, black Hardness: SH 65 Oliebestendig Oil resistant</p>	<p>30.6622 *</p>  <p>Material: EPDM, black Hardness: SH 65 Min. order: 500 m</p>	<p>31.216ST</p>  <p>Material: EPDM, black Hardness: SH 65</p>
<p>31.216GS</p>  <p>Material: Silicone, light grey Ral 7040 Hardness: SH 70</p>	<p>30.11459 *</p>  <p>Material: Transparent silicone Hardness: SH 45 Min. order: 250 m</p>	<p>34.035</p>  <p>Material: PVC, transparent Hardness: Hard</p>	<p>31.066</p>  <p>Material: Silicone, black Hardness: SH 70</p>
<p>30.6724</p>  <p>Material: EPDM, black Hardness: SH 65</p>	<p>30.14507-1 *</p>  <p>Material: EPDM, black Min. order: 3.000 m</p>	<p>30.14507-2 *</p>  <p>Material: EPDM, black Min. order: 3.000 m</p>	<p>31.068S</p>  <p>Material: EPDM, black Hardness: SH 65</p>

* Skaffevare Special order item

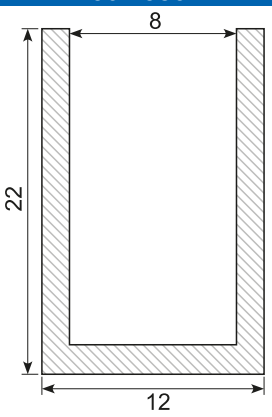
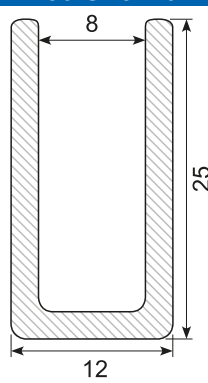
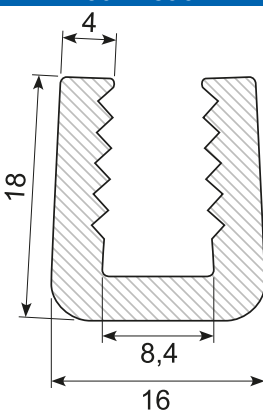
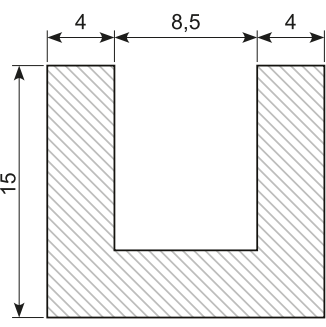
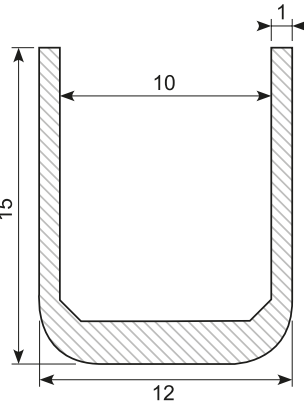
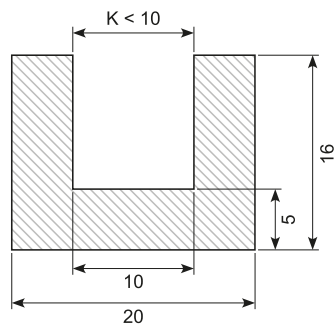
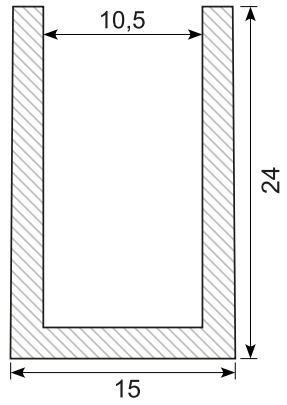
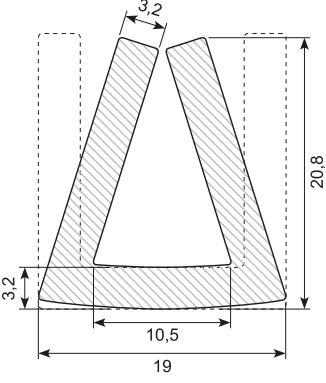
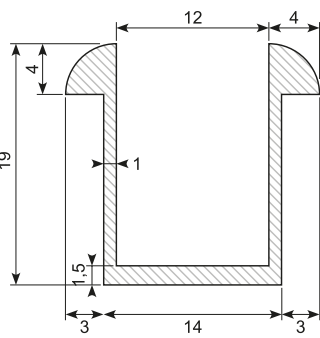
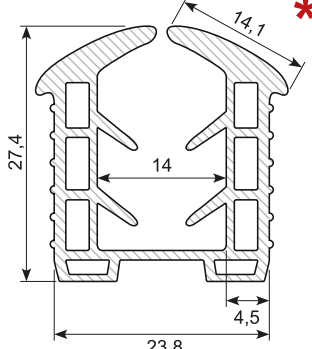
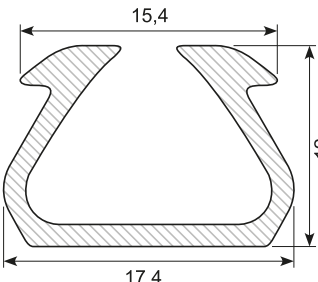
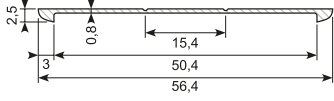
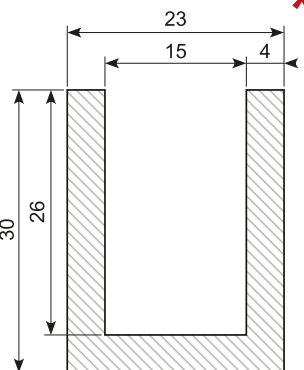
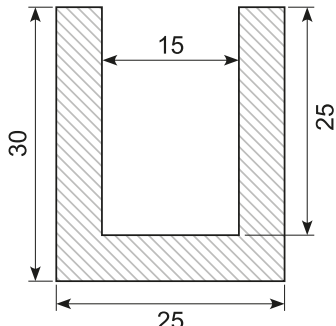
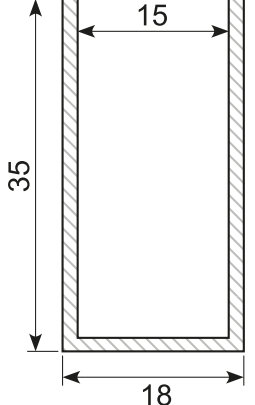
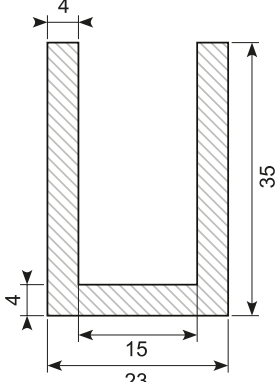
<p>30.1386</p>  <p>Material: EPDM, black Hardness: SH 65</p>	<p>30.OT3440 *</p>  <p>Material: Silicone, black Hardness: SH 60 Min. order: 100 m</p>	<p>30.12896</p>  <p>Material: EPDM, black Hardness: SH 65</p>	<p>31.074S *</p>  <p>Material: EPDM, black Min. order: 1.000 m</p>
<p>30.7987</p>  <p>Material: EPDM, black Hardness: SH 65</p>	<p>30.OT0136 *</p>  <p>Material: Silicone, white Min. order: 100 m</p>	<p>31.070S</p>  <p>Material: EPDM, black Hardness: SH 50</p>	<p>31.071S</p>  <p>Material: EPDM, black Hardness: SH 65</p>
<p>30.2455</p>  <p>Material: PVC, black Length: 3.111 mm</p>	<p>30.11774 *</p>  <p>Material: EPDM Hardness: SH 65 10-13 mm glass Min. order: 1.000 m</p>	<p>30.7508 *</p>  <p>Material: EPDM, black Hardness: SH 65 Min. order: 400 m</p>	<p>30.9519 *</p>  <p>Material: PVC soft, black Min. order: 7.000 m</p>
<p>30.12932-1 *</p>  <p>Material: EPDM, black Hardness: SH 60 Min. order: 500 m</p>	<p>30.13535 *</p>  <p>Material: EPDM, black Hardness: SH 60 Min. order: 420 m</p>	<p>30.7509</p>  <p>Material: EPDM, black Hardness: SH 65</p>	<p>30.10777-1 *</p>  <p>Material: TPE, black Hardness: SH 60 Min. order: 100 m</p>

* Skaffevare Special order item

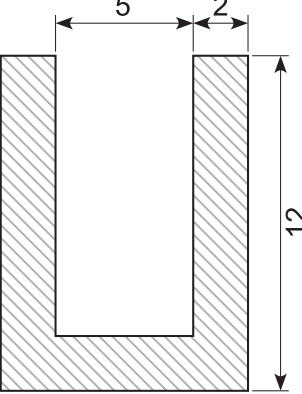
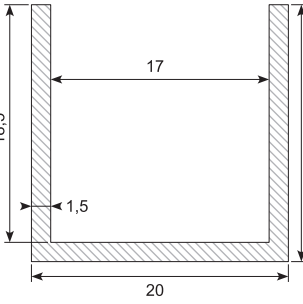
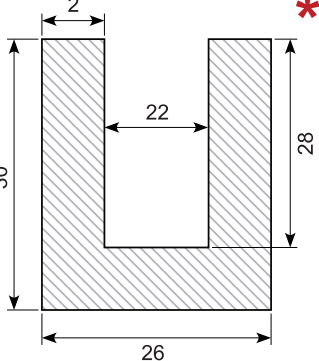
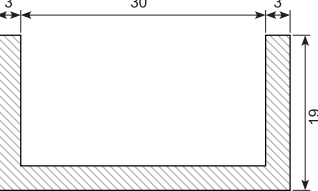
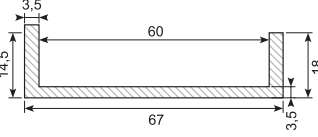
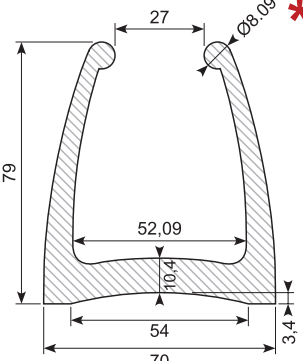
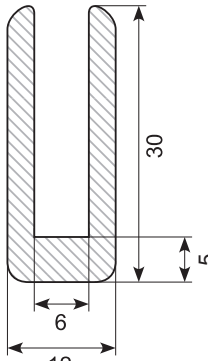
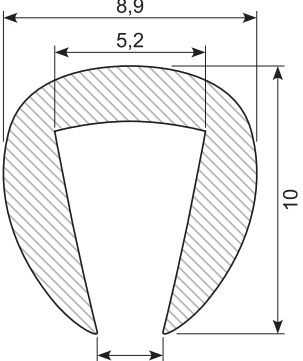
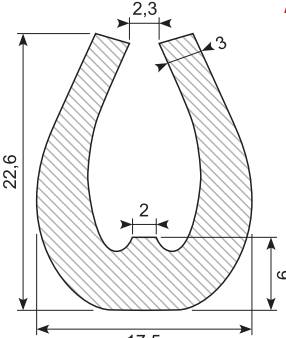
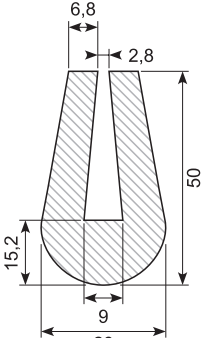
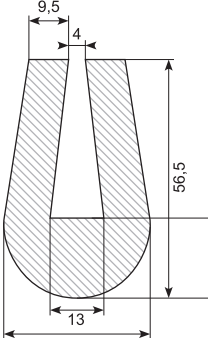
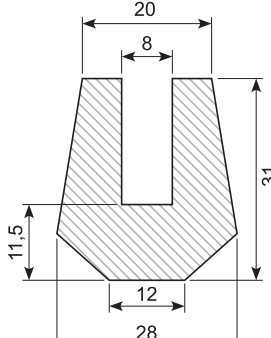
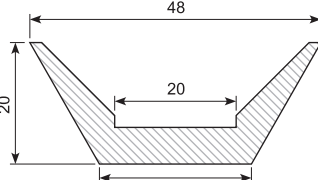
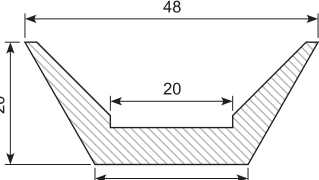
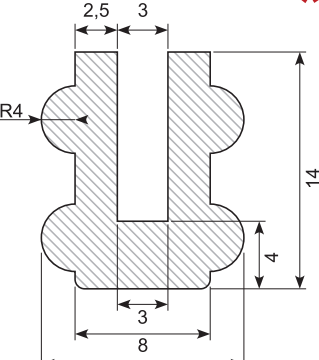
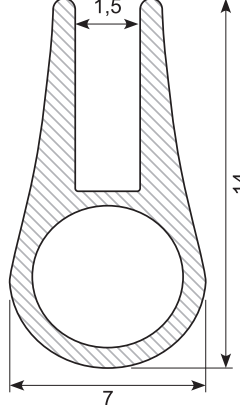
<p>30.21101205</p>  <p>Material: EPDM Hardness: SH 70</p>	<p>30.14507-3 *</p>  <p>Material: EPDM Min. order: 2.000 m</p>	<p>31.050 *</p>  <p>Material: EPDM, black Hardness: SH 65 Min. order: 500 m</p>	<p>30.14356 *</p>  <p>Material: TPE, black Hardness: SH 60 Min. order: 50 - 100 m</p>
<p>31.048 *</p>  <p>Material: EPDM, black Hardness: SH 65 Min. order: 250 m</p>	<p>30.11911 *</p>  <p>Material: EPDM Hardness: SH 65 Min. order: 300 m</p>	<p>30.2984-5</p>  <p>U-profile Material: EPDM Hardness: SH 70</p>	<p>34.117/6</p>  <p>Material: Plastic, metal grey</p>
<p>30.2984-6 *</p>  <p>U-profile Material: EPDM Hardness: SH 80 Rulle med Roll of 50 m</p>	<p>30.2984-1</p>  <p>U-profile Material: EPDM Hardness: SH 70 Rulle med Roll of 25 m</p>	<p>30.2984-2</p>  <p>U-profile Material: EPDM Hardness: SH 65 Rulle med Roll of 25 m</p>	<p>30.2984-3</p>  <p>U-profile Material: EPDM Hardness: SH 70 Rulle med Roll of 25 m</p>
<p>30.7519NBR *</p>  <p>Material: NBR, grey Hardness: SH 65 Length: 3 m Olieb Bestandig Oil resistant Min. order: 500 m</p>	<p>30.7519 *</p>  <p>Material: EPDM, black Hardness: SH 65 Length: 50 m coils Min. order: 50 - 250 m</p>	<p>30.14227 *</p>  <p>Material: Silicone, transparent Min. order: 100 m</p>	<p>31.037SI</p>  <p>Material: Silicone, black</p>

* Skaffevare Special order item

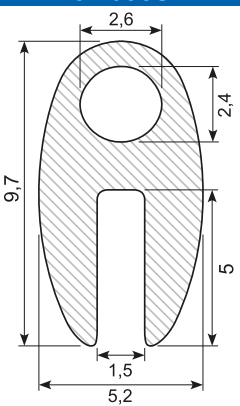
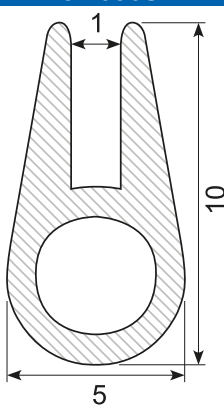
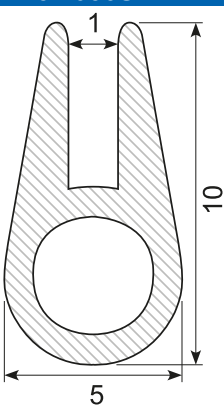
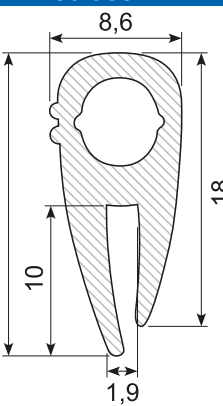
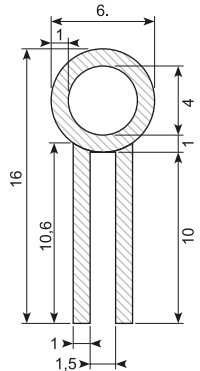
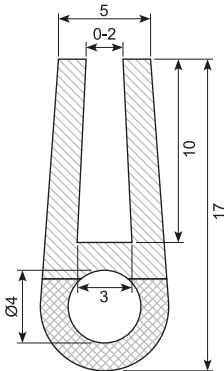
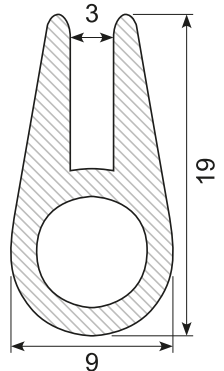
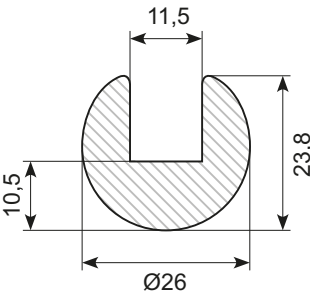
<p>31.035S</p>  <p>Material: EPDM, black Hardness: SH 65</p>	<p>31.036SI *</p>  <p>Material: Silicone, black Min. order: 200 m</p>	<p>31.036SI-LTC</p>  <p>Material: Silicone, black UL94 godkendt approved</p>	<p>30.9884X *</p>  <p>Material: EPDM Min. order: 3.000 m</p>
<p>31.037 *</p>  <p>Material: EPDM Hardness: SH 56 - 60 Min. order: 2.000 m</p>	<p>30.9885</p>  <p>Material: EPDM Hardness: SH 60</p>	<p>31.038SI</p>  <p>Material: Silicone, black Hardness: SH 60</p>	<p>30.211.04.385 *</p>  <p>Material: EPDM Hardness: SH 70 Min. order: 50 m</p>

P-profiler

P-profiles

P-profiler anvendes generelt til tætning af sprækker og andet ved f.eks. døre, vinduer og maskiner.

Alt efter hvilken hårdhed man vælger, kan man befæste profilet på flere måder. Valget af materiale afhænger af omgivelserne.

P-profiles are generally used for sealing cracks on e.g. doors, windows or machines.

Depending on the selected hardness you can attach the profile in different ways. The choice of material depends on the environment.

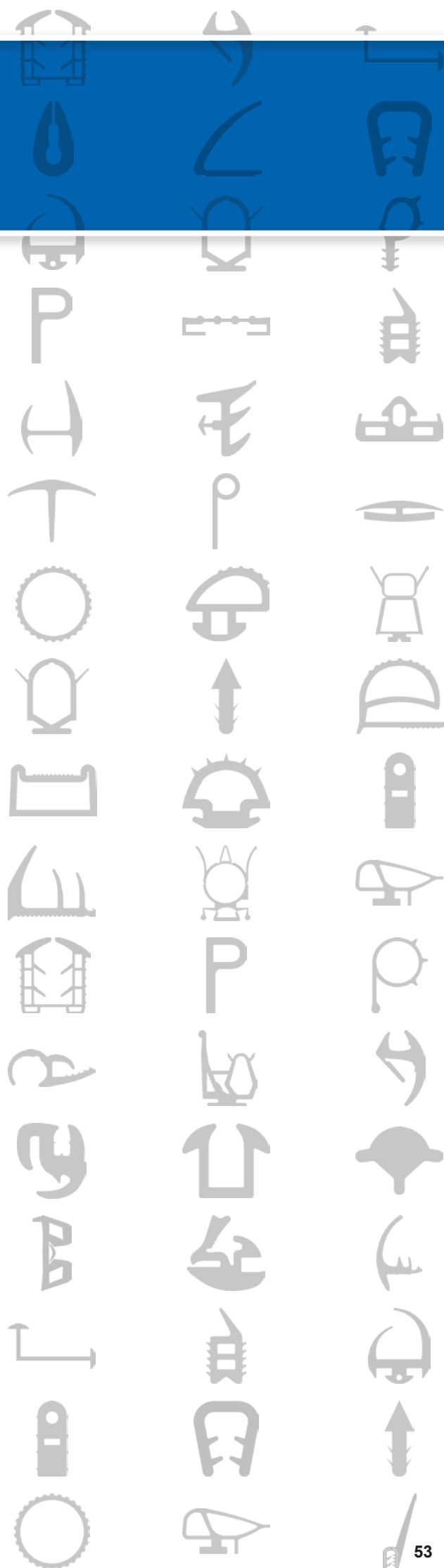

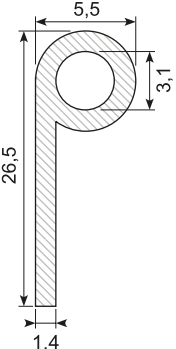
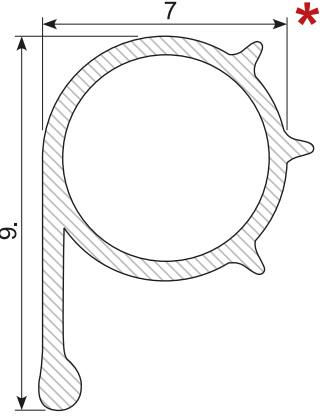
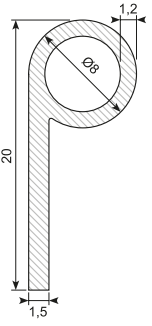
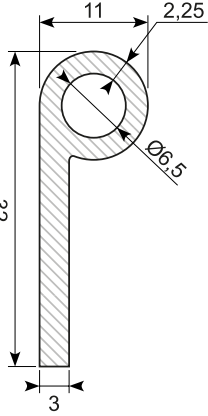
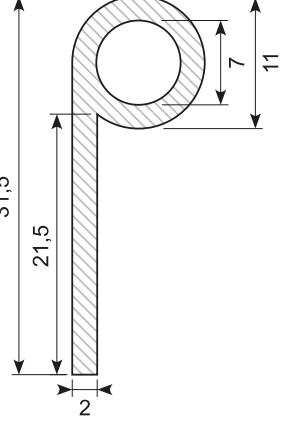
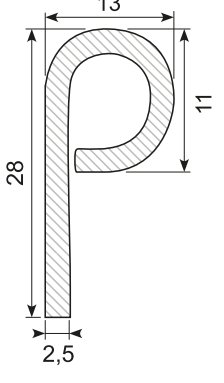
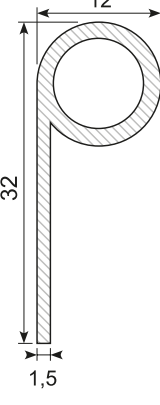
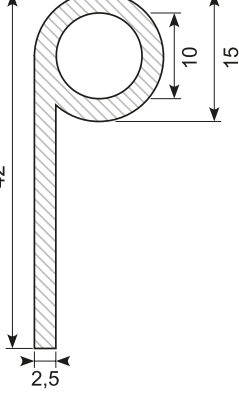
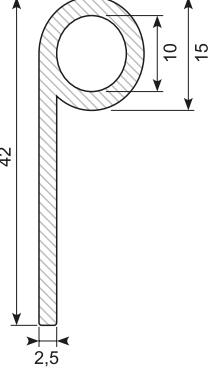
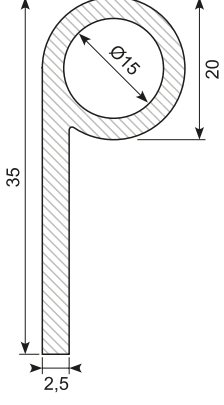
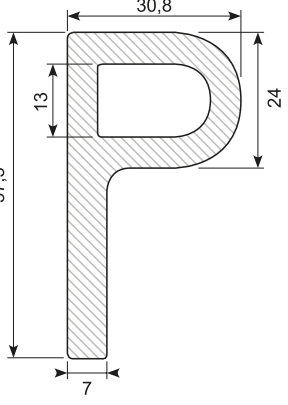
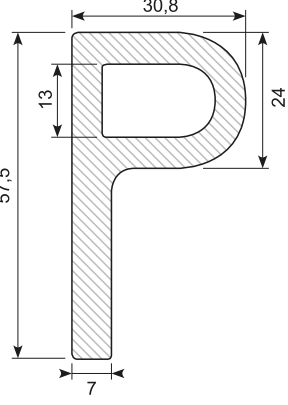
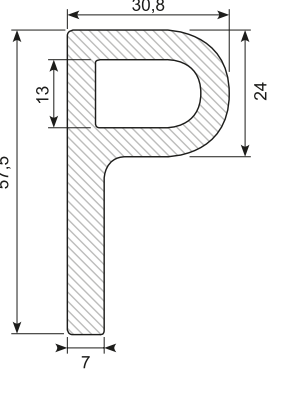
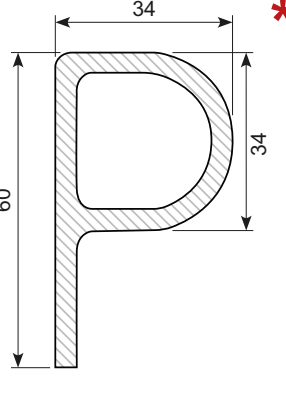
<p>30.22381</p>  <p>Material: CR, black Hardness: SH 70 Betinget oliebestandig <i>Conditional oil resistant</i></p>	<p>30.OT101</p>  <p>Material: Silicone, brown Min. order: 100 m</p>	<p>30.182</p>  <p>Material: Silicone, FDA conform, grey RAL 7040 Hardness: SH 60 Max. 180 °C</p>	<p>30.13708</p>  <p>Material: Silicone, white Hardness: SH 45</p>
<p>30.7408X</p>  <p>Material: EPDM, black</p>	<p>30.148S</p>  <p>Material: EPDM, black Hardness: SH 65 Min. order: 450 m</p>	<p>30.OT2036</p>  <p>Material: Silicone, black Max. 270 °C</p>	<p>30.138S</p>  <p>Material: EPDM, black Hardness: SH 65</p>
<p>30.138NBR</p>  <p>Material: NBR Oliebestandig Oil resistant Min. order: 100 m</p>	<p>30.140</p>  <p>Material: SEBS, black Hardness: SH 60</p>		
<p>30.136</p>  <p>Material: EPDM, black Hardness: SH 65</p>	<p>30.136/45</p>  <p>Material: EPDM, black Hardness: SH 45, soft</p>	<p>30.136NBR</p>  <p>Material: NBR, black Hardness: SH 65 Oliebestandig Oil resistant</p>	<p>30.OT1057</p>  <p>Material: Silicone, white Max. 270 °C Min. order: 50 m</p>

* Skaffevare Special order item

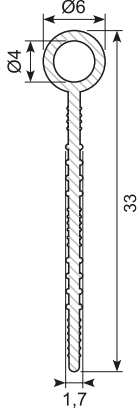
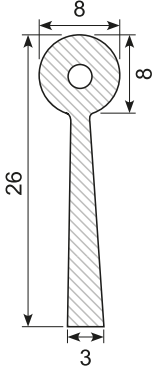
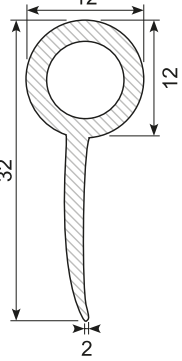
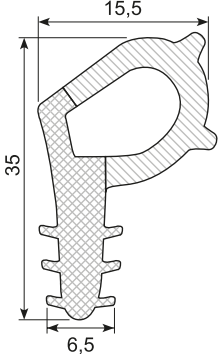
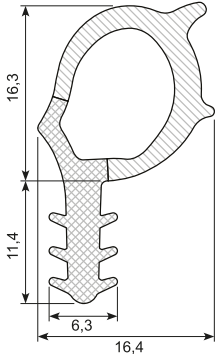
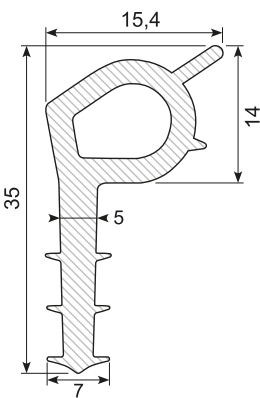
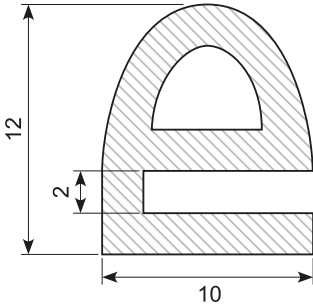
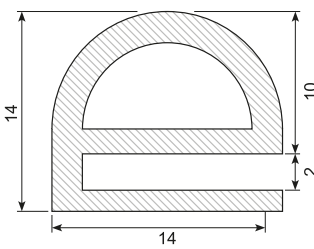
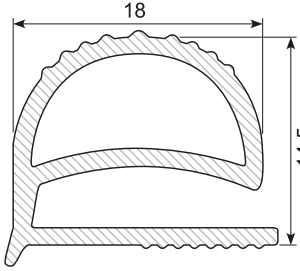
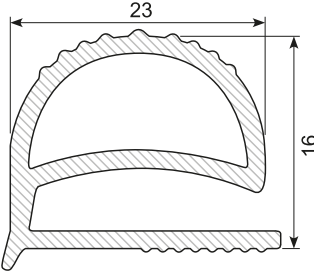
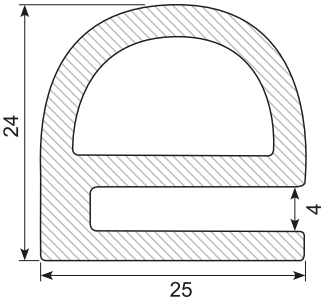
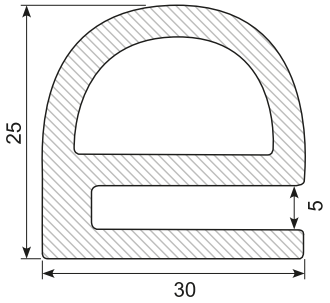
<p>52.269X</p>  <p>Material: PVC, black Hardness: Medium</p>	<p>30.176 *</p>  <p>Material: EPDM, black Hardness: SH 65 Min. order: 1.000 m</p>	<p>30.180</p>  <p>Material: EPDM, black Hardness: SH 65</p>	
<p>30.8538 *</p>  <p>Material: EPDM co-ex Hardness: SH 70 Density: 0,65 Min. order: 2.000 m</p>	<p>30.8538B *</p>  <p>Material: EPDM co-ex Hardness: SH 65 Density: 0,5 Min. order: 2.000 m</p>	<p>30.OT3271 *</p>  <p>Material: Silicone, light grey Min. order: 1.000 m</p>	
<p>30.OT1080</p>  <p>Material: Silicone, white Hardness: SH 60</p>	<p>30.OT1081</p>  <p>Material: Silicone, white</p>	<p>30.6487 *</p>  <p>Material: PVC, grey Length: 3 m Min. order: 1.000 m</p>	<p>30.SM251 *</p>  <p>Material: TPE / EPDM, grey Hardness: SH 65 Length: 25 m Min. order: 200 m</p>
<p>30.OT3334</p>  <p>Material: Silicone, white</p>	<p>31.OT2179 *</p>  <p>Material: Silicone, white Min. order: 100 m</p>		

* Skaffevare Special order item

Rudeprofiler

Glazing sections

Rudeprofiler (også kaldet rudelister) sikrer, at glasset sidder fast i rammen og beskytter det mod stød og bevægelser. Rudelister bruges til bl.a. vinduer i biler, både, busser, maskiner, campingvogne og bygninger.

Husk, at nogle rudeprofiler skal bruge en låsekile, som du kan finde i næste kapitel "Låsekiler".

Hvis du har brug for en rudeprofil med lidt anderledes mål, hjælper vi dig gerne med at finde en løsning.

Glazing sections ensure that the glass is fixed in the frame and protect it from shocks and movement.

Glazing sections are used for windows in cars, boats, buses, machinery, caravans and buildings.



Remember that for several glazing sections you need to use a filler strip, which you can find in the next chapter "Filler strips".

If you need a glazing section with a slightly different size, we will be happy to assist you to find a solution.

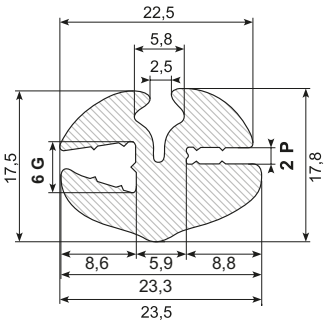
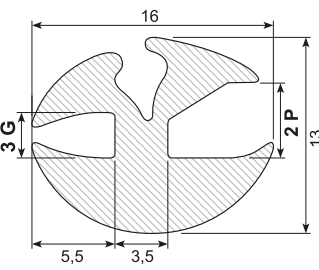
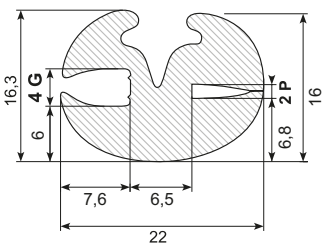
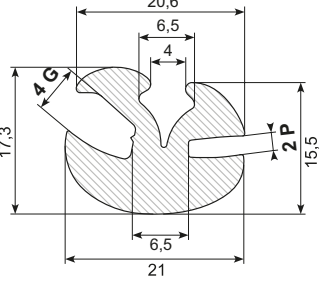
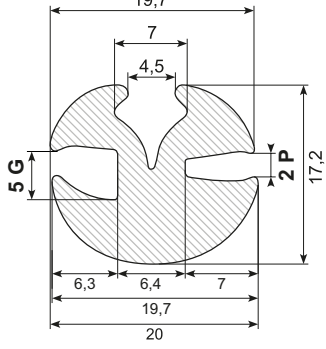
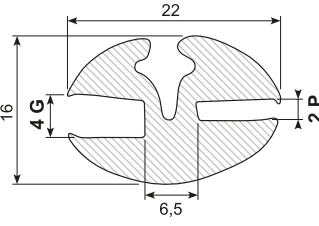
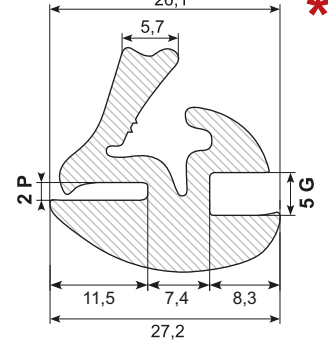
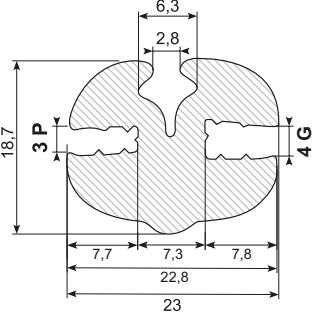
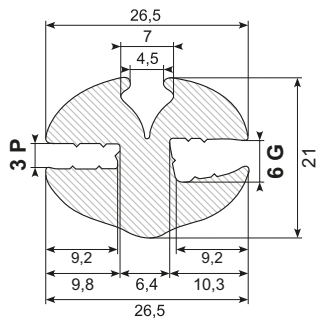
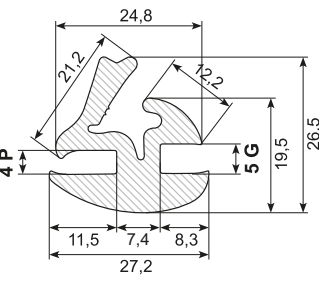
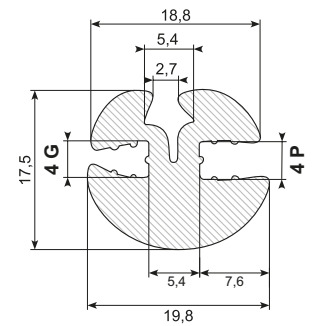
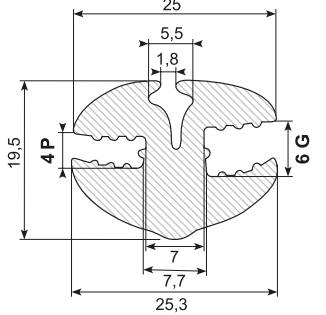
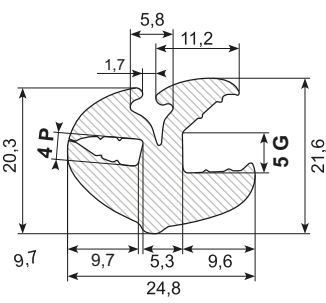
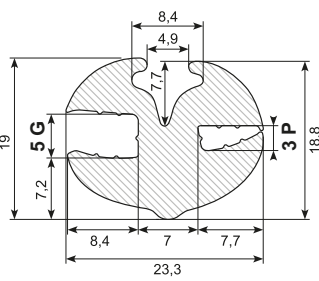
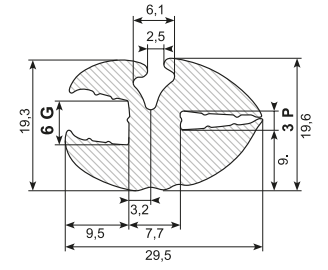
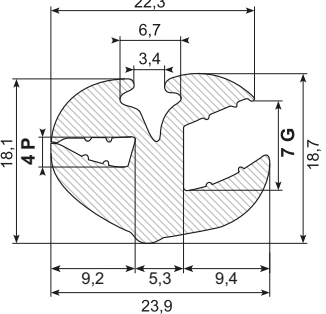

<p>32.016S</p>  <p>Material: EPDM, black Hardness: SH 65 Min. radius: 90 mm</p>	<p>32.924</p>  <p>Material: EPDM, black Hardness: SH 60 Min. radius: 30 mm Husk special låsekile <i>Remember special filler strip:</i> 32.924K</p>	<p>32.2024CR *</p>  <p>Material: CR, black Hardness: SH 65 Min. radius: 80 mm Olieb Bestandig Oil resistant Min. order: 200 m</p>	<p>32.1024S</p>  <p>Material: EPDM, black Hardness: SH 65 Min. radius: 80 mm</p>
<p>32.1025S</p>  <p>Material: EPDM, black Hardness: SH 65 Min. radius: 80 mm</p>	<p>32.2024M</p>  <p>Material: EPDM, black Hardness: SH 65 Min. radius: 80 mm</p>	<p>32.1025SK *</p>  <p>Material: EPDM, black Hardness: SH 65 Min. radius: 80 mm Inkl. kile Incl. wedge</p>	<p>32.034S</p>  <p>Material: EPDM, black Hardness: SH 65 Min. radius: 90 mm</p>
<p>32.036S</p>  <p>Material: EPDM, black Hardness: SH 65 Min. radius: 75 mm</p>	<p>32.1045SK *</p>  <p>Material: EPDM, black Hardness: SH 65 Min. radius: 80 mm Inkl. kile Incl. wedge Min. order: 100 m</p>	<p>32.044S</p>  <p>Material: EPDM, black Hardness: SH 65 Min. radius: 75 mm</p>	<p>32.046S</p>  <p>Material: EPDM, black Hardness: SH 65 Min. radius: 90 mm</p>
<p>32.2045M</p>  <p>Material: EPDM, black Hardness: SH 65 Min. radius: 90 mm</p>	<p>30.8439</p>  <p>Material: EPDM Hardness: SH 65</p>	<p>32.036X</p>  <p>Material: EPDM Hardness: SH 65</p>	<p>32.047</p>  <p>Material: EPDM, black Hardness: SH 65 Min. radius: 90 mm</p>

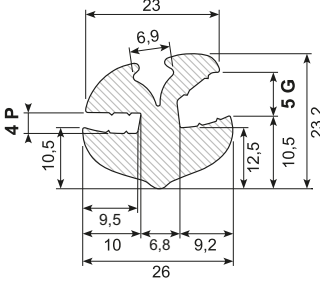
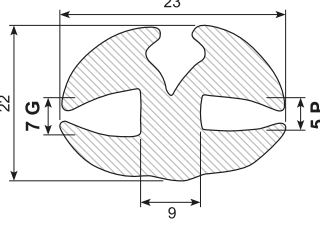
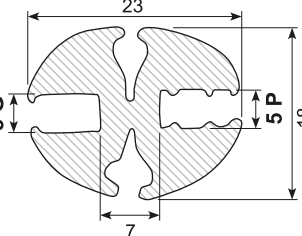
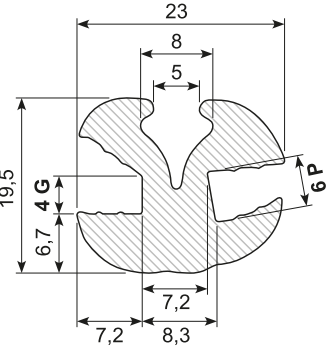
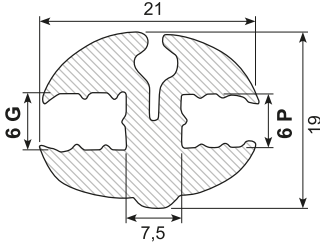
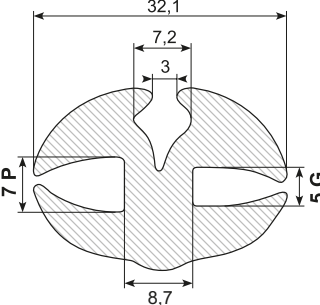
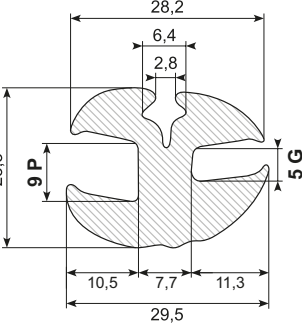
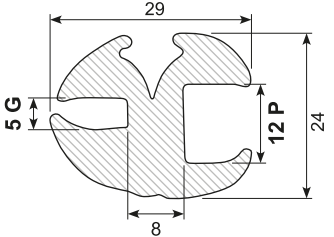
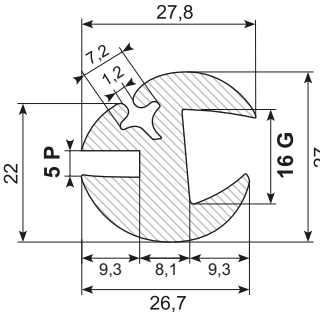
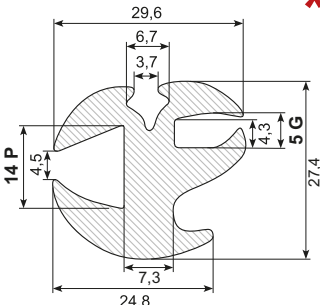
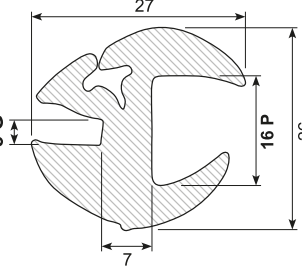
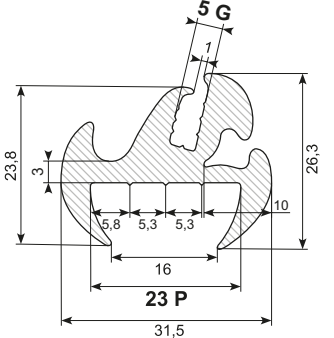
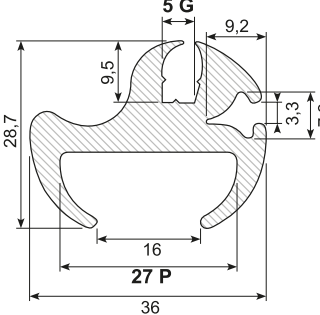
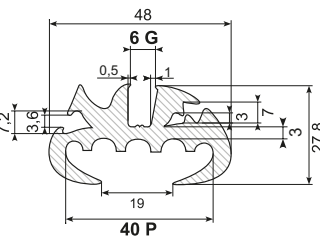
* Skaffevare Special order item

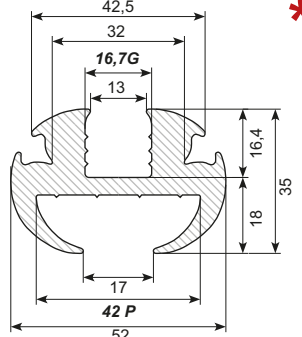
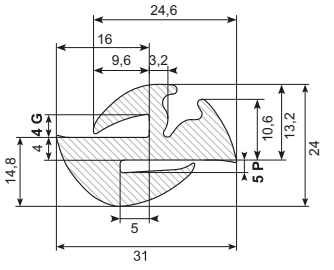
<p>32.1045S</p>  <p>Material: EPDM, black Hardness: SH 65 Min. radius: 90 mm</p>	<p>32.057 *</p>  <p>Material: EPDM, black Hardness: SH 65 Min. radius: 100 mm Min. order: 300 m</p>	<p>32.255S</p>  <p>Material: EPDM, black Hardness: SH 65 Min. radius: 100 mm</p>	<p>32.064S</p>  <p>Material: EPDM, black Hardness: SH 70</p>
<p>32.066</p>  <p>Material: EPDM, black Hardness: SH 65 Min. radius: 80 mm</p>	<p>32.075</p>  <p>Material: EPDM, black Hardness: SH 65 Min. radius: 100 mm</p>	<p>32.095S</p>  <p>Material: EPDM, black Hardness: SH 65 Min. radius: 115 mm</p>	<p>32.512</p>  <p>Material: EPDM, black Hardness: SH 65 Min. radius: 115 mm</p>
<p>32.165</p>  <p>Material: EPDM, black Hardness: SH 65 Min. radius: 120 mm</p>	<p>32.514S *</p>  <p>Material: EPDM, black Hardness: SH 65 Min. radius: 110 mm Min. order: 300 m</p>	<p>32.516S</p>  <p>Material: EPDM, black Hardness: SH 65 Min. radius: 120 mm</p>	<p>32.523S</p>  <p>Material: EPDM, black Hardness: SH 65 Min. radius: 110 mm</p>
<p>32.527</p>  <p>Material: EPDM, black Hardness: SH 65 Min. radius: 120 mm</p>	<p>32.1037S</p>  <p>Husk låsekiler <i>Remember filler strips</i></p> <p> 32.1307S  32.309X</p> <p>Material: EPDM, black Hardness: SH 65 Min. radius: 120 mm</p>	<p>32.1640 *</p>  <p>Material: EPDM, black Hardness: SH 65 Min. radius: 120 mm Min. order: 50 m</p>	<p>32.754S</p>  <p>Material: EPDM, black Hardness: SH 65 Min. radius: 100 mm Sikkerhedsgummi <i>Safety rubber</i></p>

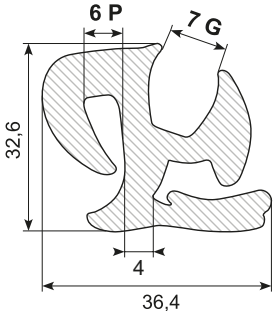
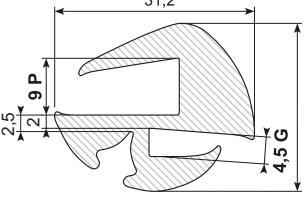
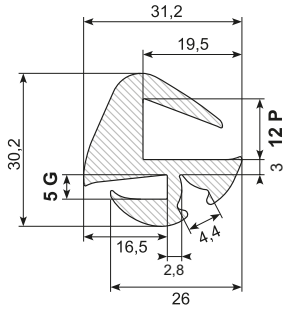
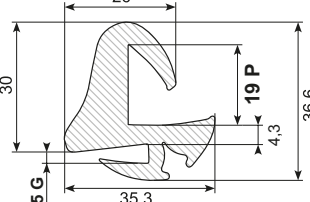
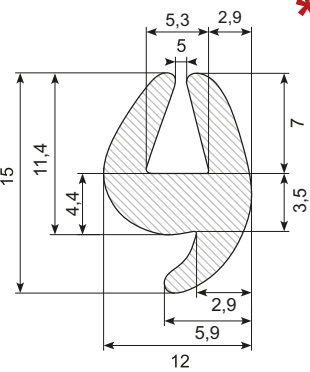
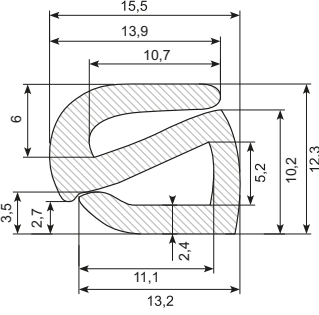
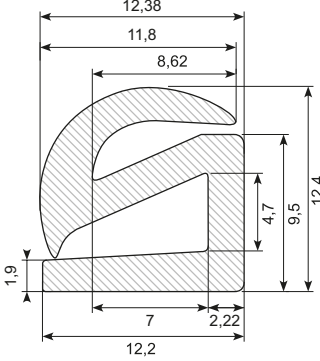
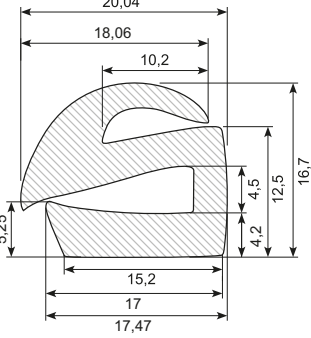
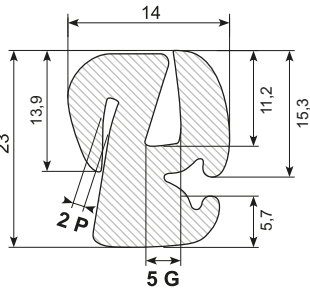
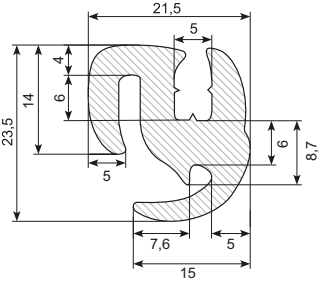
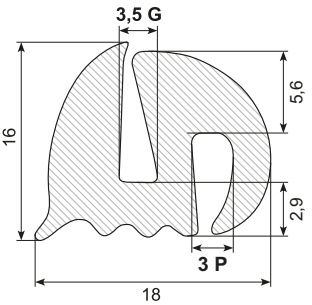
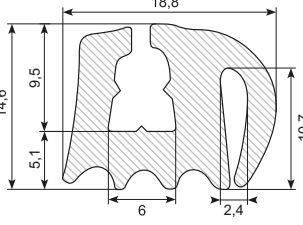
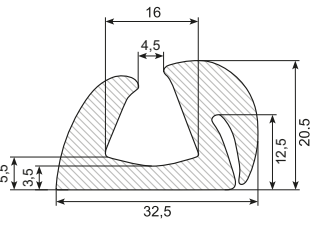
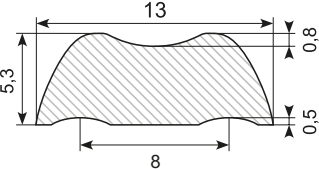
<p>32.866 *</p>  <p>Material: EPDM, black Hardness: SH 65 Min. radius: 120 mm Sikkerhedsgummi <i>Safety rubber</i> Min. order: 250 m</p>	<p>32.795S *</p>  <p>Material: EPDM, black Hardness: SH 65 Min. radius: 100 mm Sikkerhedsgummi <i>Safety rubber</i> Min. order: 50 m</p>	<p>32.7125 *</p>  <p>Material: EPDM, black Hardness: SH 65 Min. radius: 120 mm Sikkerhedsgummi <i>Safety rubber</i> Min. order: 250 m</p>	<p>32.7195S</p>  <p>Material: EPDM, black Hardness: SH 65 Min. radius: 120 mm Sikkerhedsgummi <i>Safety rubber</i></p>
<p>31.365 *</p>  <p>Material: EPDM, black Hardness: SH 65 Min. order: 1.000 m</p>	<p>31.116S</p>  <p>Material: EPDM, black Hardness: SH 65</p>	<p>31.112S</p>  <p>Material: EPDM, black Hardness: SH 65</p>	<p>31.145S</p>  <p>Material: EPDM, black Hardness: SH 65</p>
<p>31.148</p>  <p>Material: EPDM, black Hardness: SH 65</p>	<p>31.155</p>  <p>Material: EPDM, black Hardness: SH 65</p>	<p>31.6701 *</p>  <p>Material: EPDM, black Hardness: SH 65</p>	<p>31.6703 *</p>  <p>Material: EPDM, black Hardness: SH 65</p>
<p>31.6702 *</p>  <p>Material: EPDM, black Hardness: SH 65 Min. order: 500 m</p>	<p>32.1307S</p>  <p>Material: EPDM, black Hardness: SH 65</p>		

* Skaffevare Special order item

Låsekiler

Filler strips

Låsekiler anvendes som fiksering sammen med rudeprofiler. Når en rudeprofil er sat på plads, låses det med en låsekile for at sikre et fast greb om ruden.

Kilerne fås i et utal af farver og kan give en maskine eller bil et helt nyt udtryk. Låsekilen har altså ikke bare en funktionel betydning men også en æstetisk.

Filler strips are used as a fastening together with glazing sections. Once a glazing section is in place, it is fastened in place with a filler strip to ensure a tight fit around the window.

The filler strips are available in countless colors and can give a whole new look to a machine or car. The filler strip does not have just a functional significance, but also an aesthetic.

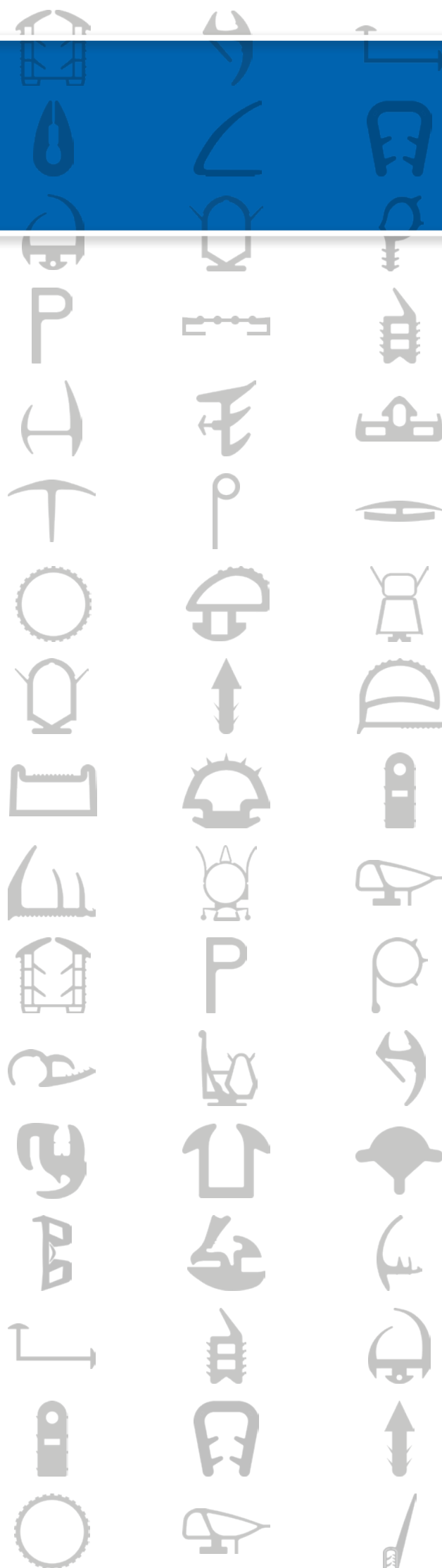

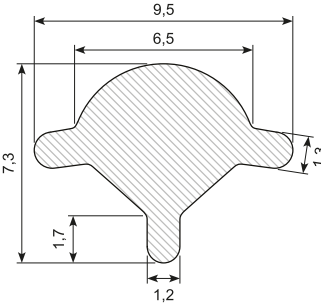
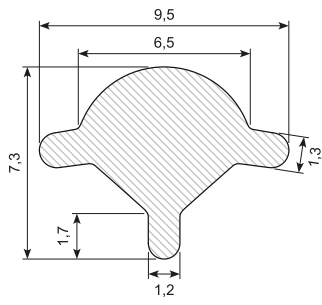
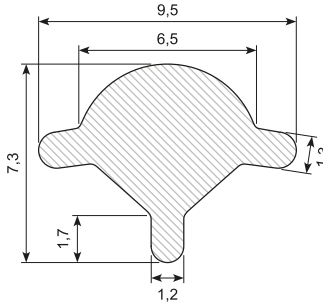
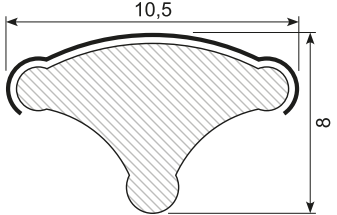
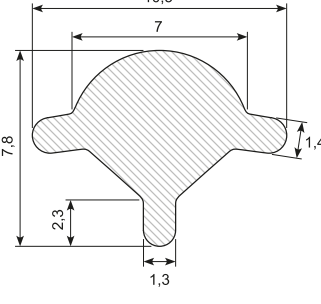
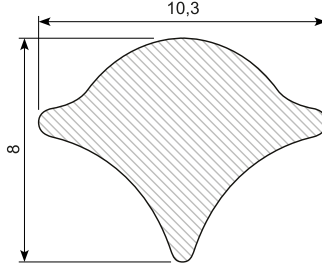
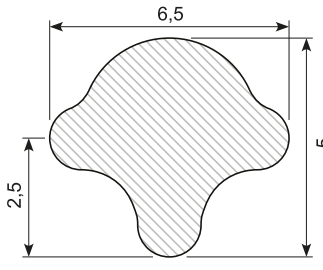
32.309X	32.301X	32.300X	32.1301
 <p>Material: PVC, black</p>	 <p>Material: PVC, dark grey</p>	 <p>Material: PVC, white</p>	 <p>Material: PVC, chrome</p>
32.409X	32.009S	32.924K	
 <p>Material: PVC, black</p>	 <p>Material: EPDM, black Hardness: SH 65</p>	 <p>Material: EPDM, black For 32.924</p>	

Svampegummi

Sponge rubber

Svampegummi er en opskummet og blød gummitype med en åben struktur og stor elasticitet. Det gør materialet optimalt til forsegling eller tætning.

Skal du bruge forsegling, hvor der f.eks. er store krav til UV- eller temperaturrestandigheden?

Eller måske til udfyldnings- og tætningsopgaver i industrien? De forseglende egenskaber er anvendelige i en lang række af industrier.

Tætningsegenskaberne ved denne gummitype kan f.eks. bruges omkring ventilations- og klimaeanlæg eller ved stanseforme, lamper, karrosseridele, stålskabe og døre. Svampegummi kan findes i forskellige gummityper med flere typer af klæb.

Sponge rubber is a foamed and soft type of rubber with a open structure and great elasticity, making the material optimal for sealing or caulking.

Do you need a sealer with high UV- or temperature resistance? Or perhaps for sealing and caulking applications in industry? The sealing properties of sponge rubber are useful in a variety of industries.

For example, the sealing properties of this type of rubber can be used around ventilation and air conditioning systems, as well as for cutting dies, lamps, body panels, steel cabinets and steel doors. Sponge rubber is available with different types of adhesive and rubber.



Svampegummisnor *Sponge rubber cord*

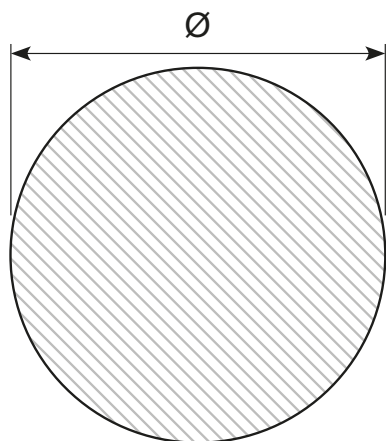

Material: EPDM, mørkegrå *dark grey*
Hardness: SH 16 - 20
Density: 0,4 - 0,5

Varenr. <i>Item no.</i>	Ø
36.102E	2 mm
36.1025E *	2,5 mm
36.103E	3 mm
36.1035E *	3,5 mm
36.1045E *	4,5 mm
36.105E *	5 mm
36.106E	6 mm
36.106EG * lysegrå <i>light grey</i>	6 mm
36.106ESP *	6 mm
36.107E	7 mm
36.108E *	8 mm
36.108EG * lysegrå <i>light grey</i>	8 mm
36.109E *	9 mm
36.110E *	10 mm
36.111E *	
36.112E *	12 mm
36.112EG lysegrå <i>light grey</i>	12 mm
36.117E	17 mm
36.118E *	18 mm
36.120E	20 mm
36.122E *	22 mm
36.125E	25 mm
36.130EX *	30 mm
36.135E *	35 mm

Material: CR, mørkegrå *dark grey*
Hardness: SH 16 - 22
Density: 0,4 - 0,6

Varenr. <i>Item no.</i>	Ø
36.103CR	3 mm
36.104CR	4 mm
36.105CR	5 mm
36.106CR	6 mm
36.107CR *	7 mm
36.108CR	8 mm
36.110CR	10 mm
36.112CR	12 mm
36.115CR sort <i>black</i>	15 mm
36.118CR * sort <i>black</i>	18 mm
36.119CR *	19 mm
36.120CR *	20 mm
36.122CR	22 mm

Material: EPDM, sort *black*
Hardness: SH 16 - 20
Density: 0,45 - 0,6

Varenr. <i>Item no.</i>	Ø	Min. order
36.7004.5X *	4,5 mm	3.000 m
36.7005X *	5 mm	3.000 m
36.7006X *	6 mm	3.000 m
36.7007X *	7 mm	3.000 m
36.7008X *	8 mm	3.000 m
36.7008.5X *	8,5 mm	3.000 m
36.7009X *	9 mm	3.000 m
36.7010X *	10 mm	3.000 m
36.7010.5X *	10,5 mm	3.000 m
36.7011X *	11 mm	3.000 m
36.7011.5X *	11,5 mm	3.000 m
36.7012X *	12 mm	3.000 m
36.7014X *	14 mm	3.000 m
36.7018X *	18 mm	
36.7028X *	28 mm	
36.7064X *	64 mm	

Material: EPDM, sort *black*
Hardness: SH 16 - 20
Density: 0,45 - 0,6

Varenr. <i>Item no.</i>	Ø
36.7003 *	3 mm
36.7004	4 mm
36.7005	5 mm
36.7006 *	6 mm
36.7008	8 mm
36.7009	9 mm
36.7010	10 mm
36.7012	12 mm
36.7015	15 mm
36.7050 *	50 mm

Svampegummislange *Sponge rubber hose*

Material: EPDM, sort *black*

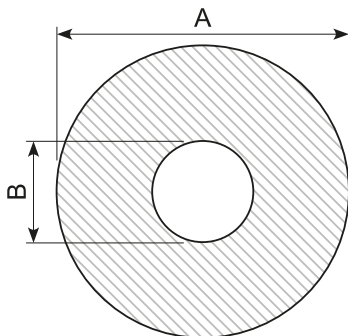

Varenr. <i>Item no.</i>	A x B	Min. order
36.34155105 *	15,5 x 10,5 mm	
36.3416068 *	16 x 6,8 mm	
36.342026 *	26 x 20 mm	1.000 m
36.342226 *	26 x 22 mm	1.000 m
36.342529 *	29 x 25 mm	1.000 m
36.342030 *	30 x 20 mm	550 m
36.342232 *	32 x 22 mm	500 m
36.342433 *	33 x 24 mm	500 m
36.341840 *	40 x 18 mm	200 m
36.342840 *	40 x 28 mm	250 m
36.344511 *	45 x 11 mm	

Svampegummi, halvrund *Sponge rubber, half round*

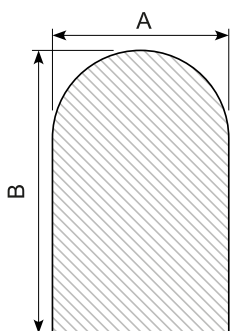

Material: EPDM

Varenr. <i>Item no.</i>	A x B	Farve <i>Color</i>
36.198 *	6 x 8 mm	Grå <i>Grey</i>
36.198S	6 x 8 mm	Sort <i>Black</i>
36.199	6 x 10 mm	Lysegrå <i>Light grey</i>
36.208	10 x 20 mm	Lysegrå <i>Light grey</i>
36.3314	12 x 17 mm	Mørkegrå <i>Dark grey</i>

* min. order: 100m

Material: CR, mørkegrå
dark grey
Hardness: SH 16 - 20
Density: 0,4

Material: NR, blågrå
blue grey
Hardness: SH 16 - 20
Density: 0,45 - 0,6

Varenr. <i>Item no.</i>	A x B	Varenr. <i>Item no.</i>	A x B
36.198CR *	6 x 8 mm	36.197	4 x 6 mm
36.200	8 x 8 mm	36.198A *	6 x 8 mm

Svampegummi *Sponge rubber*

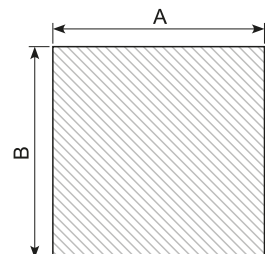

Material: EPDM, mørkegrå *dark grey*
Hardness: SH 14 - 16
Density: 0,38 - 0,42

Flere størrelser kan skaffes. Find den komplette liste på [hjemmesiden](#) ved at scanne QR-koden.
Other sizes can be ordered. Scan the QR-code to see the complete list on our homepage.



Varenr. <i>Item no.</i>	A x B	Varenr. <i>Item no.</i>	A x B	Varenr. <i>Item no.</i>	A x B	Varenr. <i>Item no.</i>	A x B
35.0806 *	8 x 6 mm	35.1515	15 x 15 mm	35.2510	25 x 10 mm	35.3535 *	35 x 35 mm
35.1003 *	10 x 3 mm	35.1605 *	16 x 5 mm	35.2515	25 x 15 mm	35.4005 *	40 x 5 mm
35.1004 *	10 x 4 mm	35.1608 *	16 x 8 mm	35.2520	25 x 20 mm	35.4010	40 x 10 mm
35.1005	10 x 5 mm	35.2003 *	20 x 3 mm	35.2525	25 x 25 mm	35.4020	40 x 20 mm
35.1007 *	10 x 7 mm	35.2005	20 x 5 mm	35.3005 *	30 x 5 mm	35.4030 *	40 x 30 mm
35.1008	10 x 8 mm	35.20055 *	20 x 5,5 mm			35.4035 *	40 x 35 mm
35.1010	10 x 10 mm	35.2010	20 x 10 mm	35.3010	30 x 10 mm	35.4040	40 x 40 mm
35.1203 *	12 x 3 mm	35.2012	20 x 12 mm	35.3012 *	30 x 12 mm	35.4505 *	45 x 5 mm
35.1209 *	12 x 9 mm	35.2015	20 x 15 mm	35.3015	30 x 15 mm	35.5005 *	50 x 5 mm
35.1212	12 x 12 mm	35.2018 *	20 x 18 mm	35.3020	30 x 20 mm	35.5006 *	50 x 6 mm
35.1503 *	15 x 3 mm	35.2020	20 x 20 mm	35.3025	30 x 25 mm	35.5010 *	50 x 10 mm
35.1507 *	15 x 7 mm	35.2502	25 x 2 mm	35.3030	30 x 30 mm	35.6010 *	60 x 10 mm
35.1510	15 x 10 mm	35.2505	25 x 5 mm	35.3505 *	35 x 5 mm	35.6040 *	60 x 40 mm
35.1512 *	15 x 12 mm	35.2506 *	25 x 6 mm	35.3510 *	35 x 10 mm		

* Skaffevare *Special order item*

Svampegummi med klæb *Sponge rubber with adhesive*

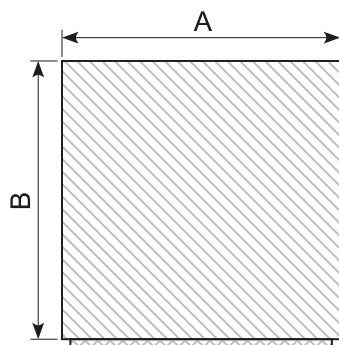

Material: EPDM, mørkegrå *dark grey*

Hardness: SH 14 - 16

Density: 0,38 - 0,42

Flere størrelser kan skaffes. Find den komplette liste på [hjemmesiden](#) ved at scanne QR-koden.

Other sizes can be ordered. Scan the QR-code to see the complete list on our homepage.



Varenr. <i>Item no.</i>	A x B
35.0806K *	8 x 6 mm
35.0808K *	8 x 8 mm
35.1003K	10 x 3 mm
35.1004K *	10 x 4 mm
35.1005K	10 x 5 mm
35.1007K *	10 x 7 mm
35.1008K	10 x 8 mm
35.1010K	10 x 10 mm
35.1203K *	12 x 3 mm
35.1204K *	12 x 4 mm
35.1204KL	12 x 4 mm
35.1206K *	12 x 6 mm
35.1208K *	12 x 8 mm
35.1209K *	12 x 9 mm
35.1212K *	12 x 12 mm
35.1503K *	15 x 3 mm
35.1504K *	15 x 4 mm
35.1505K	15 x 5 mm
35.1506K	15 x 6 mm
35.1507K *	15 x 7 mm

Varenr. <i>Item no.</i>	A x B
35.1510K	15 x 10 mm
35.1512K *	15 x 12 mm
35.1515K	15 x 15 mm
35.1605K *	16 x 5 mm
35.1608K *	16 x 8 mm
35.1708K *	17 x 8 mm
35.1803K *	18 x 3 mm
35.18053K *	18 x 5,3 mm
35.1809K *	18 x 9 mm
35.1904K *	19 x 4 mm
35.2003K	20 x 3 mm
35.2005K	20 x 5 mm
35.2006K *	20 x 6 mm
35.20055K *	20 x 5,5 mm
35.2010K *	20 x 10 mm
35.2010KL	20 x 10 mm
35.2012K	20 x 12 mm
35.2015K	20 x 15 mm
35.2020K	20 x 20 mm

Varenr. <i>Item no.</i>	A x B
35.2207K *	22 x 7 mm
35.2505K	25 x 5 mm
35.2508K *	25 x 8 mm
35.2510K	25 x 10 mm
35.2515K	25 x 15 mm
35.2520K	25 x 20 mm
35.2525K	25 x 25 mm
35.2806K	28 x 6 mm
35.3003K	30 x 3 mm
35.3005K	30 x 5 mm
35.3006K *	30 x 6 mm
35.3007K *	30 x 7 mm
35.3010K	30 x 10 mm
35.3012K	30 x 12 mm
35.3015K	30 x 15 mm
35.3020K	30 x 20 mm
35.3025K *	30 x 25 mm
35.3030K	30 x 30 mm
35.3505K *	35 x 5 mm

Varenr. <i>Item no.</i>	A x B
35.3510K *	35 x 10 mm
35.3535K *	35 x 35 mm
35.4003K	40 x 3 mm
35.4005K	40 x 5 mm
35.4010K	40 x 10 mm
35.4012K *	40 x 12 mm
35.4020K *	40 x 20 mm
35.4030K	40 x 30 mm
35.4035K *	40 x 35 mm
35.4040K	40 x 40 mm
35.4505K *	45 x 5 mm
35.5006K	50 x 6 mm
35.5010K	50 x 10 mm
35.5020K *	50 x 20 mm
35.6002K *	60 x 2 mm
35.8020K *	80 x 20 mm
35.10020K *	100 x 20 mm

Svampegummiprofil *Sponge rubber profile*

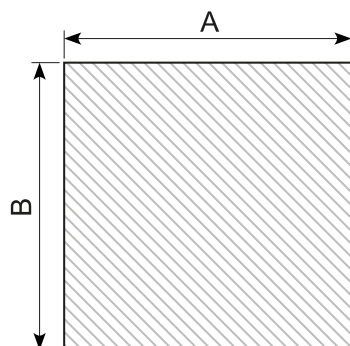

Material: EPDM, mørkegrå *dark grey*

Hardness: SH 16 - 20

Density: 0,4 - 0,5

Varenr. <i>Item no.</i>	A x B
36.1010E	10 x 10 mm
36.1210E *	12 x 10 mm
36.1503E *	15 x 3 mm
36.1505E	15 x 5 mm
36.1510E *	15 x 10 mm
36.1512E *	15 x 12 mm
36.1612E *	16 x 12 mm
36.1815EG*	18 x 15 mm

Varenr. <i>Item no.</i>	A x B
36.2010E *	20 x 10 mm
36.2520E *	25 x 20 mm
36.2525E *	25 x 25 mm
36.3010E *	30 x 10 mm
36.3025E *	30 x 25 mm
36.3520E *	35 x 20 mm
36.4010E *	40 x 10 mm

Varenr. <i>Item no.</i>	A x B
36.4015E *	40 x 15 mm
36.4020E *	40 x 20 mm
36.4025E *	40 x 25 mm
36.4030E *	40 x 30 mm
36.5010E	50 x 10 mm
36.5020E *	50 x 20 mm
36.6030E *	60 x 30 mm

* Skaffevare *Special order item*

Svampegummi *Sponge rubber*

Material: NR, mørkegrå *dark grey*

Hardness: SH 16 - 20

Density: 0,4 - 0,5

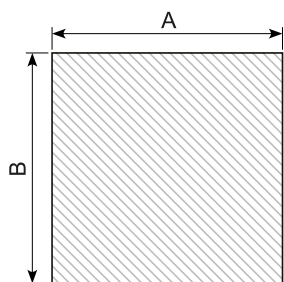

Varenr. <i>Item no.</i>	A x B
36.0505 *	5 x 5 mm
36.0806 *	8 x 6 mm
36.1005	10 x 5 mm
36.1005G * lysegrå <i>light grey</i>	10 x 5 mm
36.1007 *	10 x 7 mm
36.1008 *	10 x 8 mm
36.1010 * sort <i>black</i>	10 x 10 mm
36.1205 *	12 x 5 mm
36.1206 *	12 x 6 mm
36.1210 *	12 x 10 mm
36.1503 *	15 x 3 mm
36.1510 *	15 x 10 mm
36.1512 *	15 x 12 mm
36.1515 *	15 x 15 mm
36.1604 *	16 x 4 mm

Varenr. <i>Item no.</i>	A x B
36.1605 *	16 x 5 mm
36.1808G *	18 x 8 mm
36.1816 *	18 x 16 mm
36.2002 *	20 x 2 mm
36.2003 *	20 x 3 mm
36.2005 *	20 x 5 mm
36.2010	20 x 10 mm
36.2020	20 x 20 mm
36.2503 *	25 x 3 mm
36.2505 *	25 x 5 mm
36.2510 *	25 x 10 mm
36.2515 *	25 x 15 mm
36.2520 *	25 x 20 mm
36.2525 *	25 x 25 mm
36.3003 *	30 x 3 mm

Varenr. <i>Item no.</i>	A x B
36.3005 *	30 x 5 mm
36.3010	30 x 10 mm
36.3020 *	30 x 20 mm
36.3030 *	30 x 30 mm
36.3516 *	35 x 16 mm
36.4010 *	40 x 10 mm
36.4012 *	40 x 12 mm
36.4015 *	40 x 15 mm
36.4025 *	40 x 25 mm
36.5010 *	50 x 10 mm
36.5020 *	50 x 20 mm
36.5025 *	50 x 25 mm
36.5030 *	50 x 30 mm

Svampegummi *Sponge rubber*

Material: Economy EPDM, sort *black*

Density: 0,45

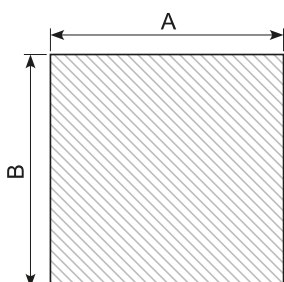

Varenr. <i>Item no.</i>	A x B	Min. order
36.1005X *	10 x 5 mm	3.000 m
36.1007X *	10 x 7 mm	3.000 m
36.1406X *	14 x 6 mm	3.000 m
36.1505X *	15 x 5 mm	3.000 m
36.1507X *	15 x 7 mm	3.000 m
36.2005X *	20 x 5 mm	3.000 m
36.2008X	20 x 8 mm	
36.2505X *	25 x 5 mm	3.000 m
36.2507X *	25 x 7 mm	3.000 m
36.2508X *	25 x 8 mm	3.000 m
36.3003X *	30 x 3 mm	
36.3005X *	30 x 5 mm	
36.3006X *	30 x 6 mm	3.000 m
36.3305X *	33 x 5 mm	3.000 m
36.5005X *	50 x 5 mm	2.000 m

Varenr. <i>Item no.</i>	A x B	Bløde hjørner <i>Soft corners</i>	Min. order
36.1010X *	10 x 10 mm		3.000 m
36.1210X *	12 x 10 mm		3.000 m
36.1212X *	12 x 12 mm		3.000 m
36.12511X*	12,5 x 11 mm		3.000 m
36.1612X *	16 x 12 mm		3.000 m
36.2010X *	20 x 10 mm		3.000 m
36.2318X *	23 x 18 mm		2.000 m
36.2512X *	25 x 12 mm	Ja <i>Yes</i>	2.000 m
36.3015X *	30 x 15 mm		1.500 m
36.3020X *	30 x 20 mm	Ja <i>Yes</i>	1.500 m
36.3515X *	35 x 15 mm	Ja <i>Yes</i>	1.500 m
36.3520X *	35 x 20 mm	Ja <i>Yes</i>	1.000 m
36.4010X *	40 x 10 mm		2.000 m
36.4020X	40 x 20 mm	Ja <i>Yes</i>	3.000 m
36.5010X *	50 x 10 mm		1.000 m

Material: CR, sort *black*

Hardness: SH 18 - 25

Density: 0,5 - 0,75

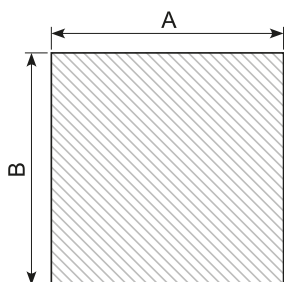

Varenr. <i>Item no.</i>	A x B
36.1010CR *	10 x 10 mm
36.2010CR *	20 x 10 mm
36.2020CR *	20 x 20 mm
36.3015CR *	30 x 15 mm
36.64004CR *	40 x 4 mm
36.4020CR *	40 x 20 mm
36.60503CR *	50 x 3 mm
36.5005CR *	50 x 5 mm

* Skaffevare *Special order item*

Silikonesvampegummi *Silicone sponge rubber*

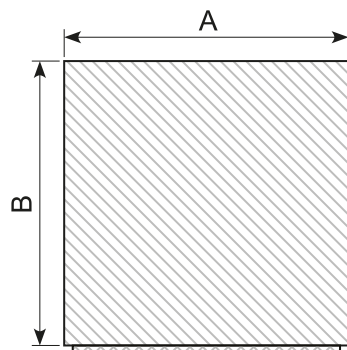

Industry quality: -60°C / +220°C
Med klæb *With tape*: -60°C / +180°C
Material: Silicone, råhvid *off white*
Hardness: SH 16 - 20
Density: 0,4 - 0,5
F: FDA
K: Med klæb *With adhesive*

Varenr. <i>Item no.</i>	A x B
36.1010SIH *	10 x 10 mm
36.1512SIH *	15 x 12 mm
36.1515SIH	15 x 15 mm
36.1610SIH	16 x 10 mm
36.2003SIH *	20 x 3 mm
36.2005SIH *	20 x 5 mm
36.2005SIHK *	20 x 5 mm
36.2010SIH *	20 x 10 mm
36.2010SIHK *	20 x 10 mm
36.2015SIH *	20 x 15 mm
36.2020SIH *	20 x 20 mm
36.2020SIHF *	20 x 20 mm
36.2505SIHF *	25 x 5 mm
36.2510SIH	25 x 10 mm
36.2515SIH *	25 x 15 mm
36.2520SIH	25 x 20 mm
36.3005SIHK *	30 x 5 mm
36.3020SIH *	30 x 20 mm
36.4005SIHK *	40 x 5 mm
36.4012SIH *	40 x 12 mm

Industry quality: -60 °C / +200 °C
Material: Silicone, hvid *white*
Hardness: SH 16 - 20
Density: 0,55 - 0,65

I overensstemmelse med (E6) 1935/2004 og EU 10/2011 i kontakt med fødevarer *Compliant to (E6) 1935/2004 and EU 10/2011 in contact with food*

F: FDA
K: Med klæb. Disse kan ikke anvendes i kontakt med fødevarer *With adhesive. These can not be used in contact with food*

Varenr. <i>Item no.</i>	A x B
36.1204SIHKF *	12 x 4 mm
36.1505SIHF *	15 x 5 mm
36.1616SIHF *	16 x 16 mm
36.2005SIHF *	20 x 5 mm
36.3005SIHKF *	30 x 5 mm

Industry quality: -60°C / +200°C
Material: Silicone, hvid *white*
Hardness: SH 16 - 20
Density: 0,55 - 0,65

Varenr. <i>Item no.</i>	A x B
36.1006SIH *	10 x 6 mm
36.1212SIH	12 x 12 mm
36.1505SIH *	15 x 5 mm
36.2525SIH *	25 x 25 mm
36.3010SIH *	30 x 10 mm
36.5005SIH *	50 x 5 mm

Svampegummiplader *Sponge rubber plates*

Density: 0,6

Color: Mørkegrå *Dark grey*

Size: 1 x 1 m

Varenr. <i>Item no.</i>	Tykkelse <i>Thickness</i>	Materiale <i>Material</i>
38.152EPDM	2 mm	EPDM
38.153EPDM	3 mm	EPDM
38.154EPDM *	4 mm	EPDM
38.155EPDM *	5 mm	EPDM
38.156EPDM *	6 mm	EPDM
38.158EPDM *	8 mm	EPDM
38.160EPDM *	10 mm	EPDM
38.162EPDM *	12 mm	EPDM
38.165EPDM *	15 mm	EPDM
38.170EPDM	20 mm	EPDM
38.175EPDM	25 mm	EPDM
38.180NR *	30 mm	NR

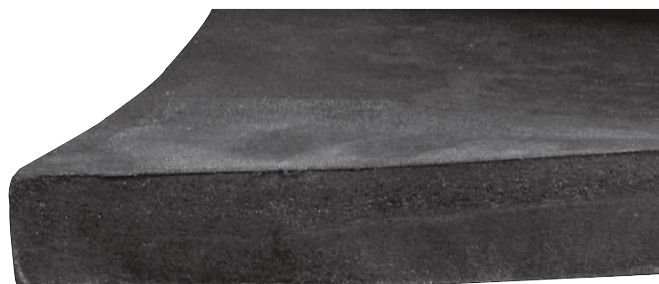

Mange svampegummiplader vil udgå pga. min. ordre 50 stk. Se evt. cellegummiplader om alternativ

Many sponge rubber sheets will be discontinued due to min. order 50 pcs. See cellular rubber sheets for alternative

Svampegummi med svøb *Sponge rubber with shell*

36.K608	36.K613	36.K616	36.K671
*	*	*	*
<p>Color: Black</p>	<p>Color: Black</p>	<p>Color: Black</p>	<p>Color: Black</p>
36.K675	36.K676	36.K677	36.K678
*	*	*	*
<p>Color: Black</p>	<p>Color: Black</p>	<p>Color: Black</p>	<p>Color: Black</p>

* Skaffevare *Special order item*

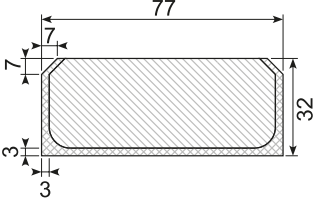
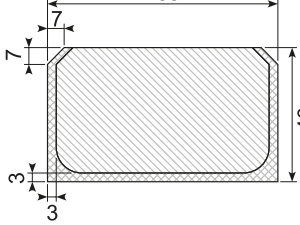
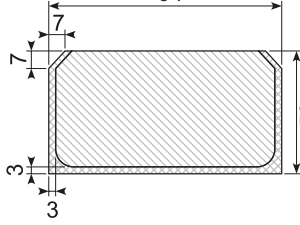
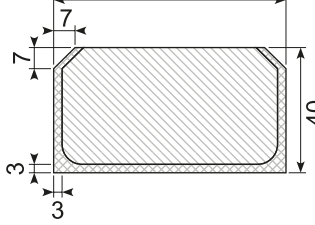
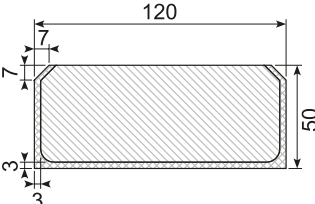
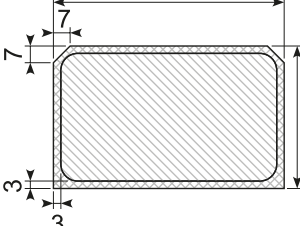
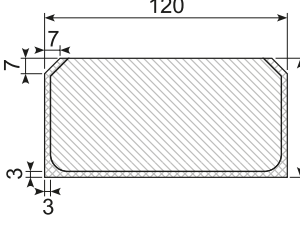
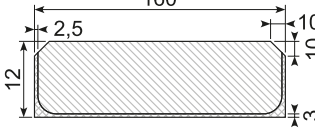
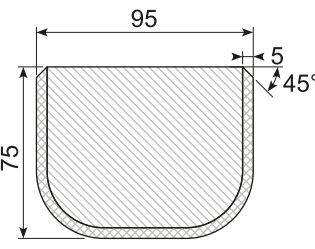
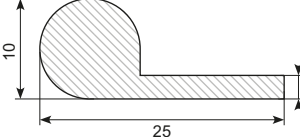
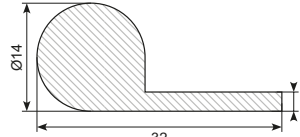
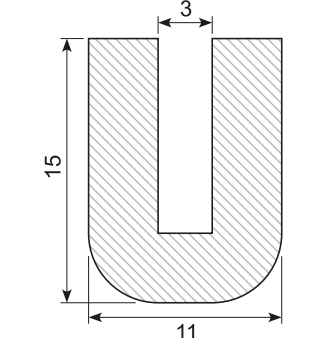
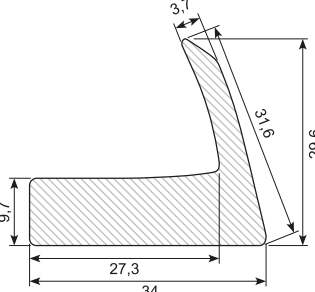
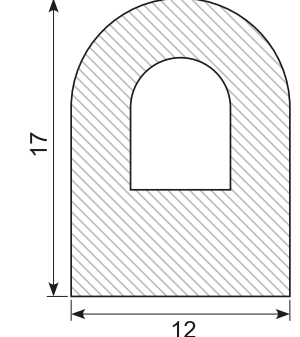
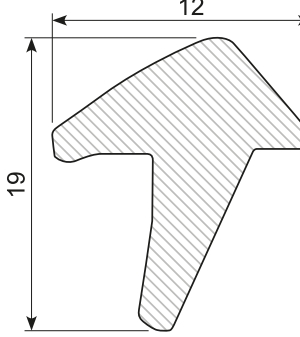
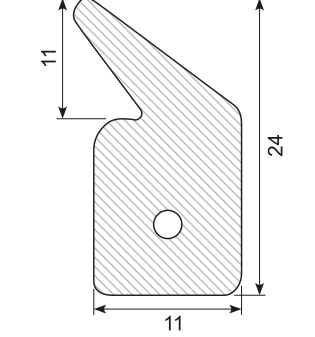
<p>36.K679 *</p>  <p>Color: Black</p>	<p>36.K680 *</p>  <p>Color: Black</p>	<p>36.K681 *</p>  <p>Color: Black</p>	<p>36.K683 *</p>  <p>Color: Black</p>
<p>36.K695 *</p>  <p>Color: Black</p>	<p>36.K697 *</p>  <p>Color: Black</p>	<p>36.K698 *</p>  <p>Color: Black</p>	<p>36.K852 *</p>  <p>Color: Black</p>
<p>36.K853 *</p>  <p>Color: Black</p>	<p>36.3351 *</p>  <p>Material: EPDM, black Hardness: SH 14 - 16 Density: 0,38 - 0,4 Min. order: 100 m</p>	<p>36.3354 *</p>  <p>Material: NR, dark grey Hardness: SH 16-20 Density: 0,4 Min. order: 2.400 m</p>	<p>36.3813</p>  <p>Material: EPDM, dark grey Hardness: SH 16-20 Density: 0,4 - 0,45</p>
<p>36.B380</p>  <p>Material: EPDM Length: 3 m</p>	<p>36.3315</p>  <p>Material: EPDM, black Hardness: SH 18 - 20 Density: 0,45 - 0,55</p>	<p>36.3504</p>  <p>Material: EPDM, dark grey Hardness: SH 14 - 16 Density: 0,38 - 0,42</p>	<p>36.3881 / 36.3881S *</p>  <p>Material: EPDM, grey/black Hardness: SH 16 - 20 Density: 0,4 - 0,5 36.3881S * : Black</p>

* Skaffevare Special order item

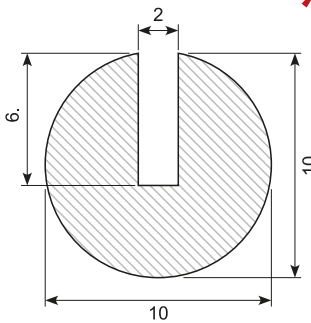
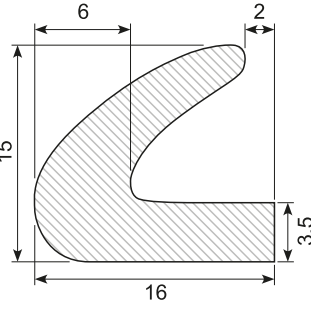
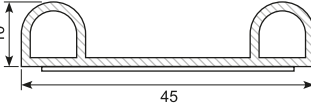
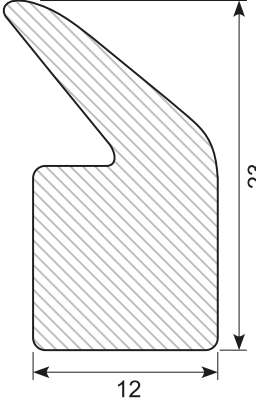
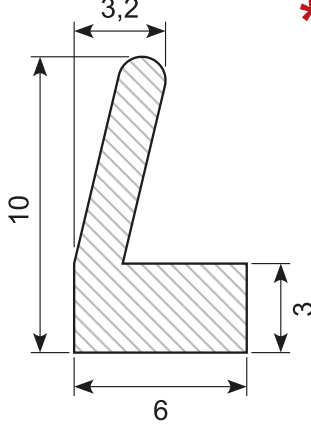
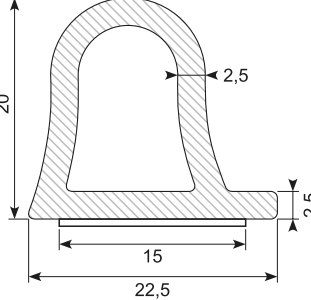
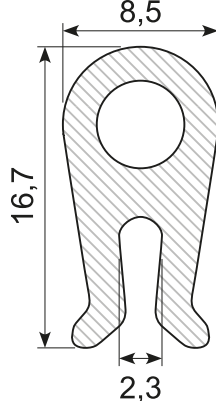
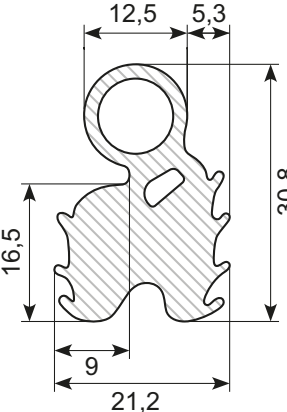
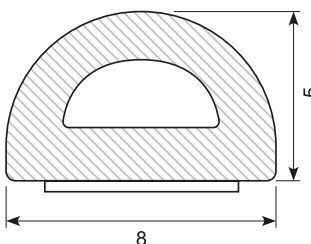
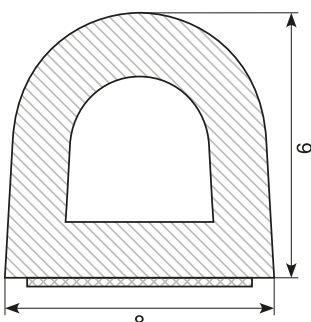
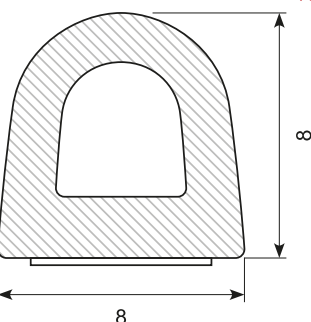
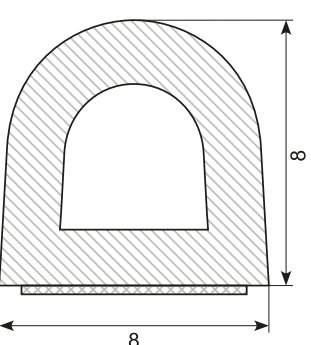
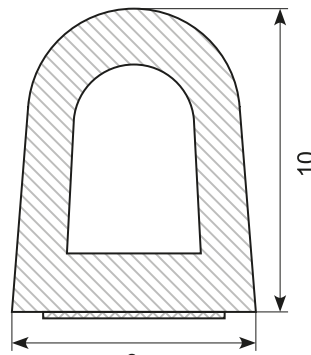
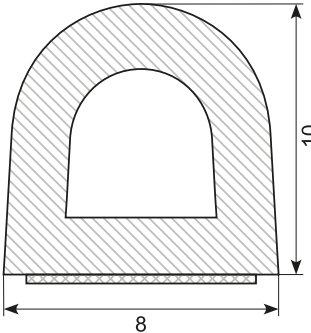
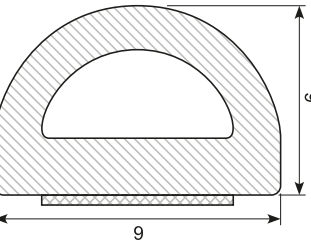
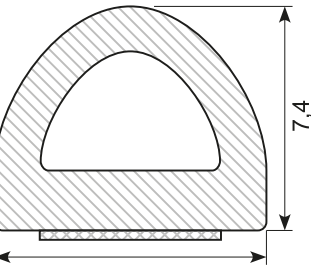
<p>36.14044 *</p>  <p>Material: EPDM Min. order: 500 m</p>	<p>36.3704</p>  <p>Material: NR, dark grey Hardness: SH 20 - 25 Density: 0,55 - 0,65</p>	<p>30.13144XX</p>  <p>Material: Sponge EPDM Med klæb With adhesive</p>	<p>36.3882</p>  <p>Material: CR, black</p>
<p>36.3897 *</p>  <p>Material: EPDM, light grey</p>	<p>30.13315 *</p>  <p>Material: EPDM Density: 0,7 Med klæb With adhesive Min. order: 1.000 m</p>	<p>30.9884S *</p>  <p>Material: EPDM Min. order: 3.000 m</p>	<p>30.E368</p>  <p>Material: EPDM, black</p>
<p>36.730805H *</p>  <p>Material: EPDM, white Density: 0,25 - 0,40 Med klæb With adhesive Min. order: 21.600 m</p>	<p>36.9086S</p>  <p>Material: EPDM, black Density: 0,35 Med klæb With adhesive</p>	<p>36.730808 *</p>  <p>Material: EPDM, black Density: 0,25 - 0,35 Med klæb With adhesive Min. order: 21.600 m</p>	<p>36.9088S</p>  <p>Material: EPDM, black Density: 0,35 Med klæb With adhesive</p>
<p>36.730810</p>  <p>Material: EPDM, black Density: 0,35 - 0,45 Med klæb With adhesive</p>	<p>36.90810</p>  <p>Material: EPDM, black Density: 0,35 - 0,45 Med klæb With adhesive</p>	<p>36.730906 / 36.730906H *</p>  <p>Material: EPDM, black / white Density: 0,25 - 0,35 Med klæb With adhesive 36.730906H: Min. order: 4.800 m</p>	<p>36.730907 / 36.730907G / 36.730907H</p>  <p>Material: EPDM, black / light grey / white Density: 0,25 - 0,35 Med klæb With adhesive</p>

* Skaffevare Special order item

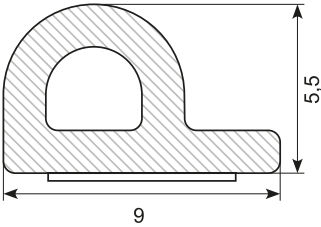
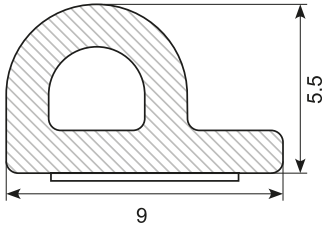
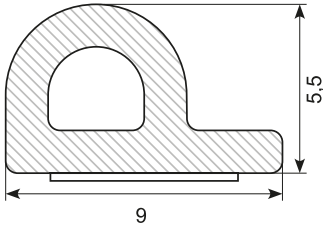
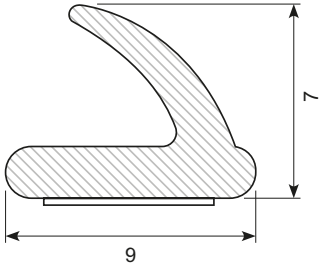
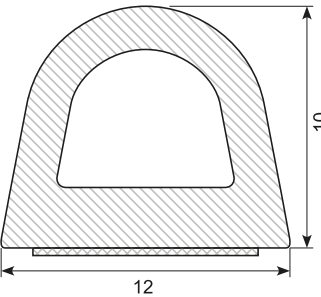
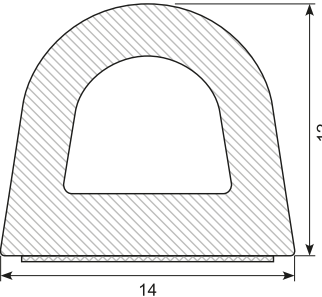
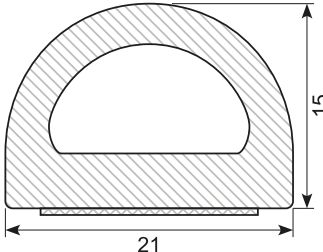
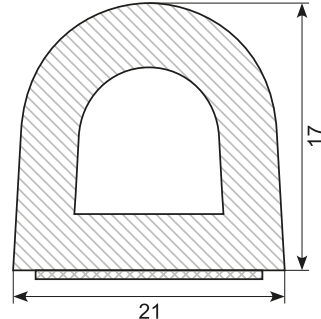
<p>36.730955</p>  <p>Material: EPDM, black Density: 0,25 - 0,35 Med klæb <i>With adhesive</i></p>	<p>36.730955G/36.730955H/36.730955B</p>  <p>Material: EPDM, 36.730955G: Grey 36.730955H: White 36.730955B *: Brown Density: 0,25 - 0,35</p>	<p>36.80955S</p>  <p>Material: EPDM, black Density: 0,35 Med klæb <i>With adhesive</i></p>	<p>36.740907H *</p>  <p>Material: EPDM, white Density: 0,35 - 0,45 Med klæb <i>With adhesive</i> Min. order: 21.600 m</p>
<p>36.731210 / 36.731210H</p>  <p>Material: EPDM, black / white Density: 0,25 - 0,35 Med klæb <i>With adhesive</i></p>	<p>36.731412D</p>  <p>Material: EPDM, black Density: 0,25 - 0,35 Med klæb <i>With adhesive</i></p>	<p>36.732115</p>  <p>Material: EPDM, black Density: 0,45 - 0,55 Med klæb <i>With adhesive</i></p>	<p>36.92117</p>  <p>Material: EPDM, black Density: 0,35 Med klæb <i>With adhesive</i></p>

Skaffevarer - Svampegummiprofiler *Special order - Sponge rubber profiles*

Vi kan skaffe mange svampegummiprofiler i forskellige udformninger. Herunder ser du et lille udvalg og i vores katalog kan du finde endnu flere muligheder. Find kataloget på vores hjemmeside eller ved at scanne QR-koden. Pris og varenummer på forespørgsel.

We can supply many sponge rubber profiles in different shapes. Below you can see a small selection and in our catalog you can find even more options. Find the catalog on our website or by scanning the QR code. Price and item number on request.



* Skaffevarer *Special order item*

Fenderlister

Fender lists

Fendere er stødabsorberende gummiemner, som ofte bruges til både, trucks, lastbiler og på havne.

Vi har fenderlister i bl.a. sort, grå og hvid PVC. De findes i forskellige mål og konstruktioner, og de er alle UV-bestandige og slidstærke.

Fenders are shock absorbing rubber items commonly used for boats, in harbors, forklifts and trucks.

We have fender lists in black, grey and white PVC. They are available in different sizes and constructions, but they are all UV resistant and durable.

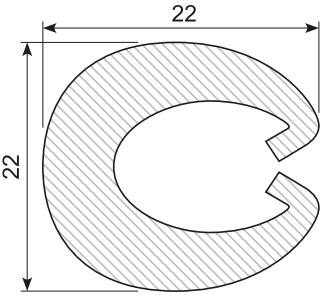
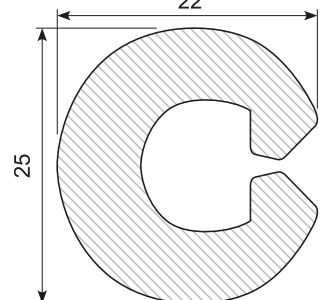
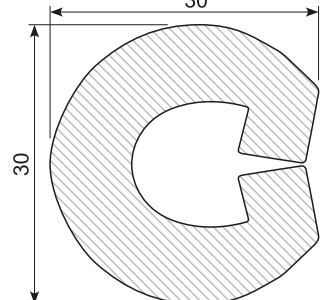
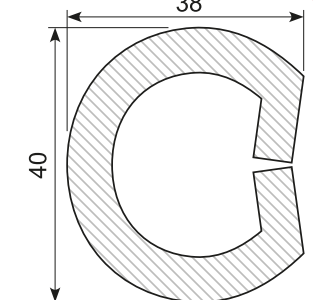
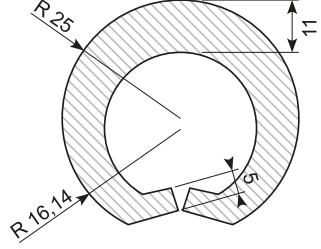
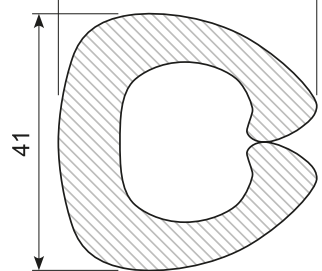
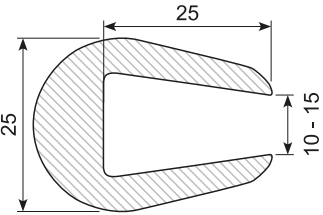
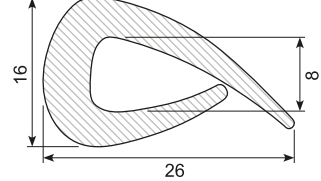
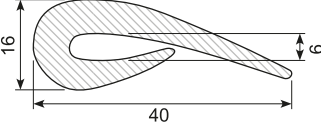
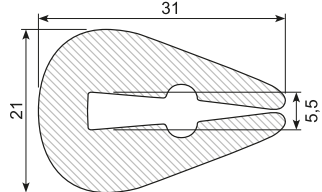
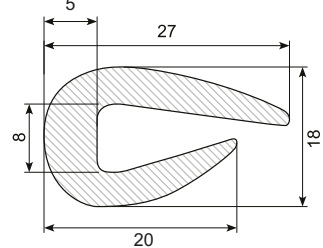
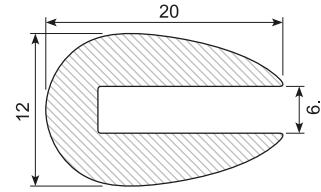
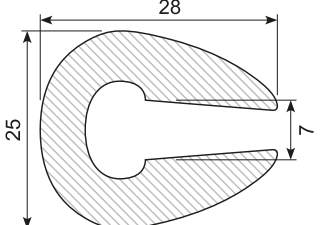
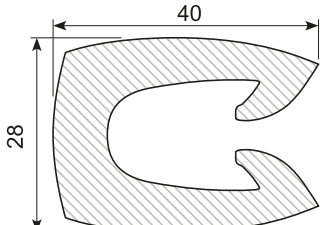
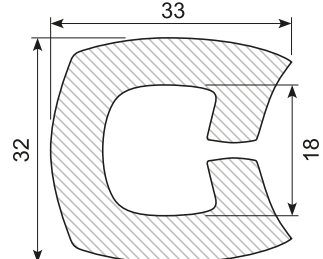
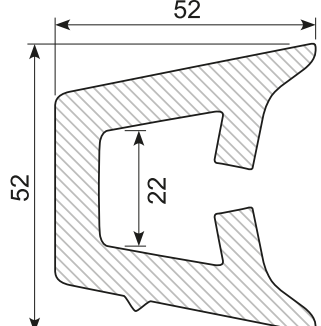

<p>34.601 * / 34.601G *</p>  <p>Material: PVC, black Min. order: 5 m 34.601G: Grey Min. order: 50-500 m</p>	<p>34.602 / 34.602G *</p>  <p>Material: PVC, black Min. order: 5 m 34.602G *: Grey Min. order: 50 m</p>	<p>34.603 / 34.603G</p>  <p>Material: PVC, black 34.603G: Grey</p>	<p>34.604 *</p>  <p>Material: PVC, black Min. order: 5 m</p>
<p>34.7102-50 *</p>  <p>Material: PVC, black Min. order: 5 m</p>	<p>34.614 *</p>  <p>Material: PVC, black Min. order: 50 m</p>	<p>34.3032 *</p>  <p>Material: PVC, black Min. order: 51 m</p>	<p>34.641 *</p>  <p>Material: PVC, black Min. order: 50 m</p>
<p>34.643</p>  <p>Material: PVC, black</p>	<p>34.644 *</p>  <p>Material: PVC, black Min. order: 50 m</p>	<p>34.620010</p>  <p>Material: PVC, black</p>	<p>34.620040</p>  <p>Material: PVC, black</p>
<p>34.620210</p>  <p>Material: PVC, black</p>	<p>34.613</p>  <p>Material: PVC, black</p>	<p>34.7196</p>  <p>Material: PVC, black</p>	<p>34.7199 *</p>  <p>Material: PVC, black Min. order: 25 m</p>

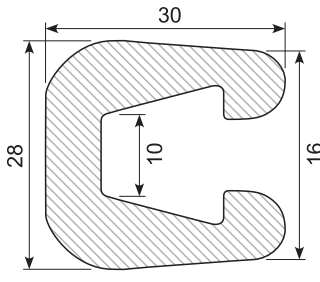
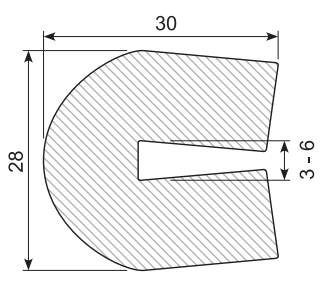
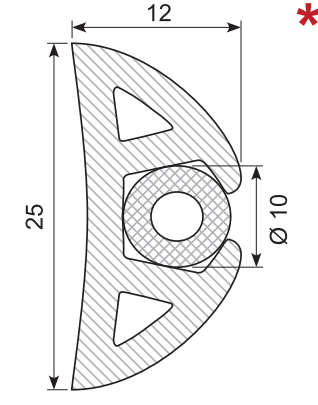
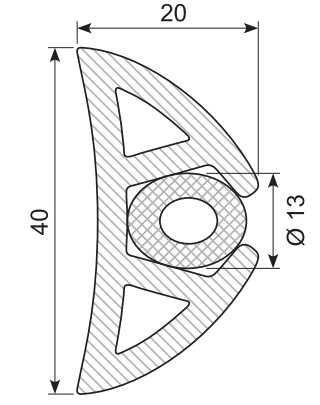
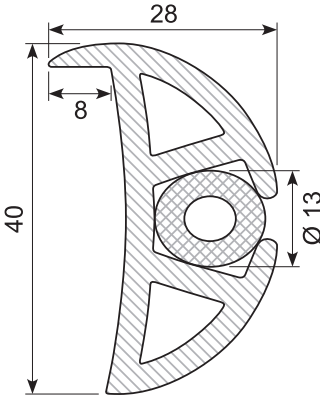
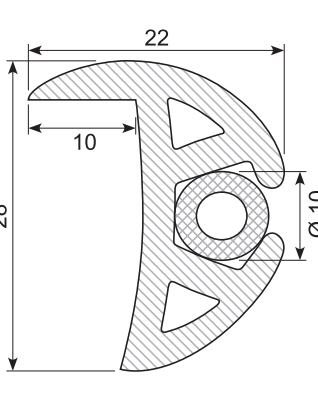
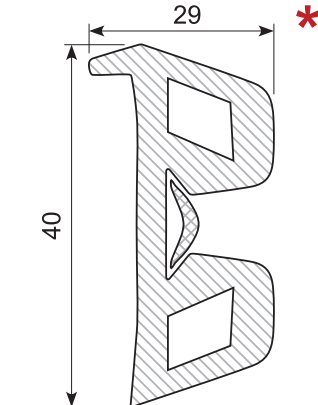
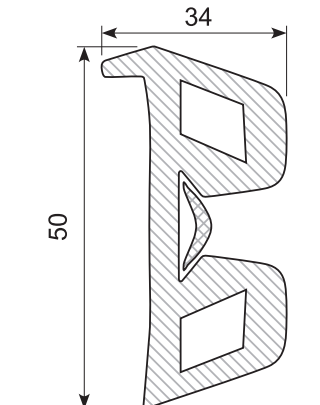
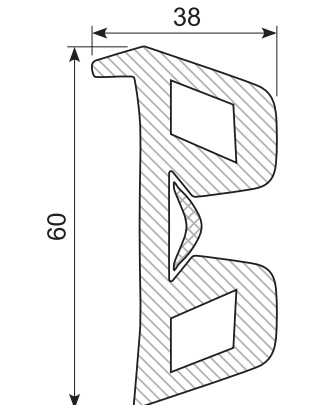
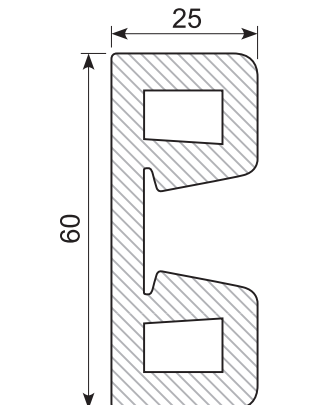
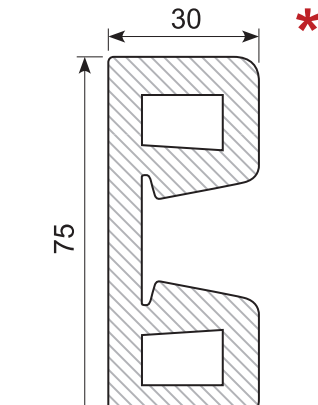
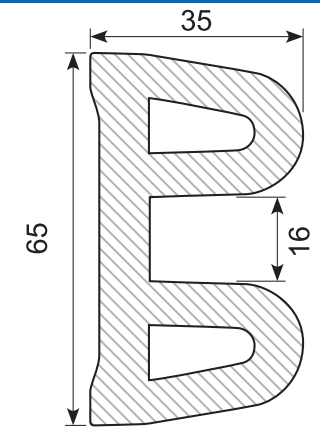
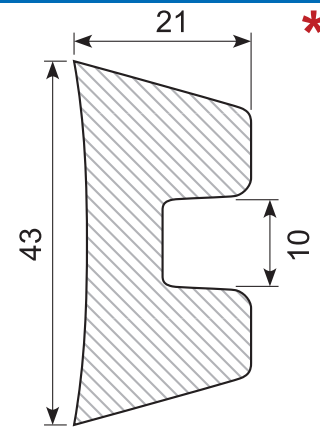
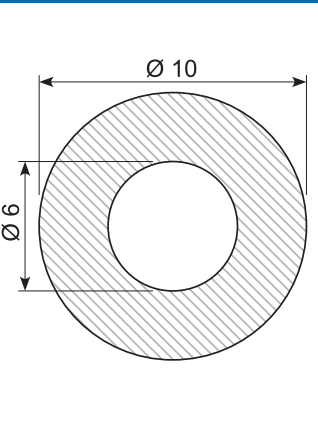
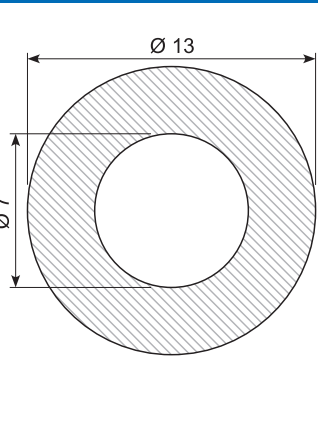
<p>34.620140 *</p>  <p>Material: PVC, black Min. order: 5 m</p>	<p>34.3011 *</p>  <p>Material: PVC, black</p>		<p>34.62039 *</p>  <p>Material: PVC, black Min. order: 5 m</p>
<p>34.62040</p>  <p>Material: PVC, black</p>	<p>34.620420</p>  <p>Material: PVC, black</p>	<p>34.62041</p>  <p>Material: PVC, black</p>	<p>34.624 *</p>  <p>Material: PVC, black Min. order: 50 m</p>
<p>34.625</p>  <p>Material: PVC, black</p>	<p>34.626</p>  <p>Material: PVC, black</p>	<p>34.636</p>  <p>Material: PVC, black</p>	<p>34.637 *</p>  <p>Material: PVC, black Min. order: 50 m</p>
<p>34.3020</p>  <p>Material: PVC, black</p>	<p>34.7514 *</p>  <p>Material: PVC, black Min. order: 5 m</p>	<p>34.62610S</p>  <p>Material: PVC, black</p>	<p>34.62713H</p>  <p>Material: PVC, white</p>

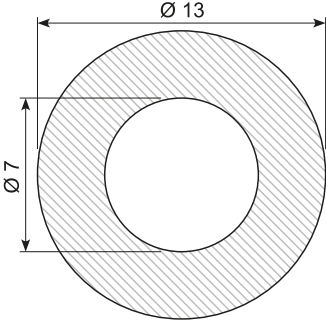
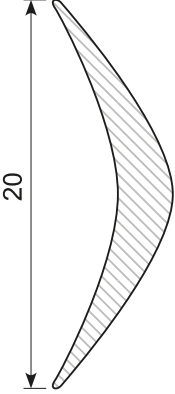
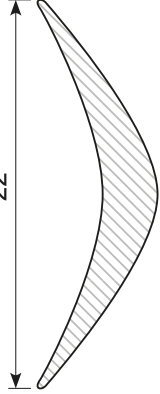
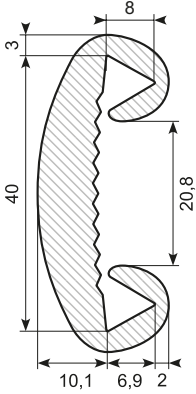
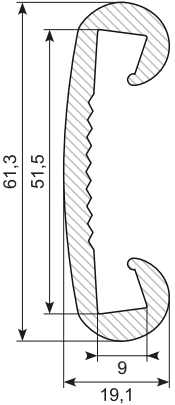
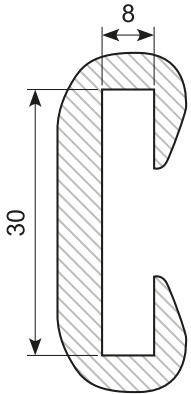
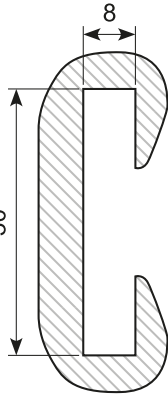
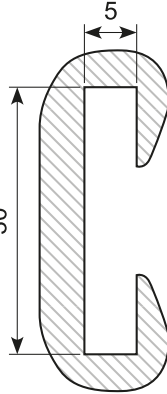
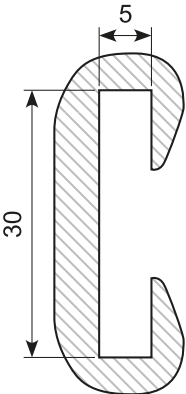
<p>34.62713S</p>  <p>Material: PVC, black</p>	<p>34.677 *</p>  <p>Material: PVC, white Min. order: 50 m</p>	<p>34.678 *</p>  <p>Material: PVC, white Min. order: 50 m</p>	<p>34.608X</p>  <p>Material: PVC, black</p>
<p>34.609X</p>  <p>Material: PVC, black</p>	<p>34.606 *</p>  <p>Material: PVC, black Min. order: 100 m</p>	<p>34.606X *</p>  <p>Material: PVC, black Min. order: 500 m</p>	<p>34.607</p>  <p>Material: PVC, black</p>
<p>34.607X *</p>  <p>Material: PVC, black Min. order: 500 m</p>			

Glasbånd

Window seals

Glasbånd med klæb er multianvendeligt og kan bruges til f.eks. vinduer, drivhuse og termoglas, en utæt havedør eller som mellemlæg eller tætning ved pandeplader og stålprofiler.

Ligesom svampegummi vil denne gummitype nemt forme sig efter alle strukturer og modvirke lækager.

Materialer og farver er der mange af, så du altid får et produkt, der dækker behovet.

Window seals with adhesive is versatile for windows, greenhouses and thermal glass, a leaking garden door or as a spacer. Like sponge rubber, this kind of rubber easily molds to all structures and counteracts leaks.

There are many materials and colors, so you can always get a product that suits your requirements.

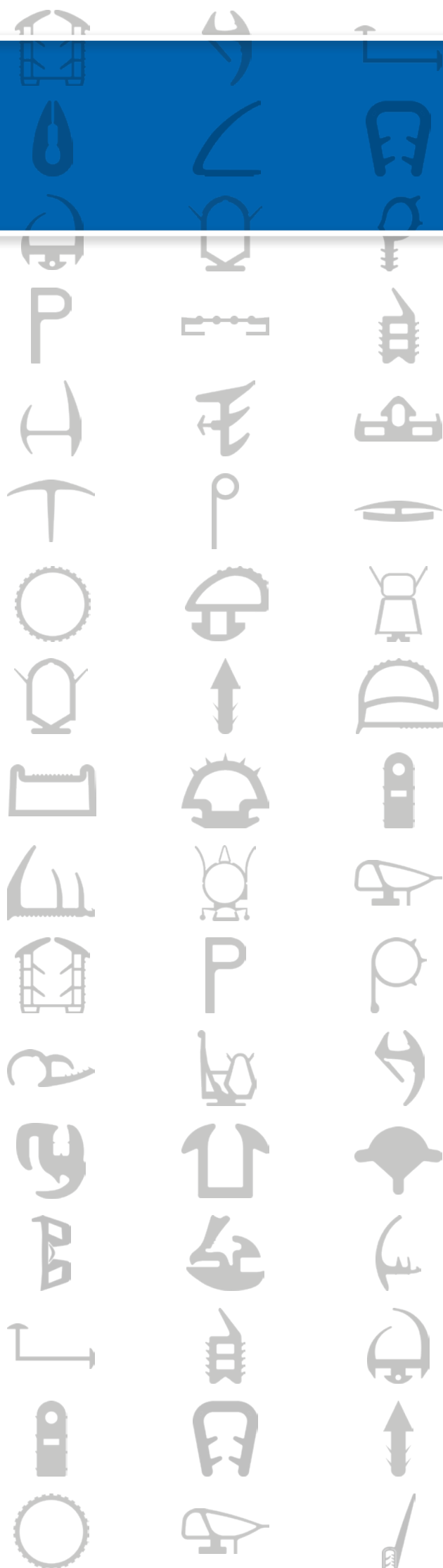

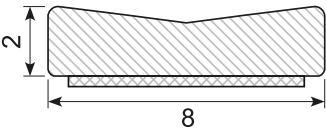
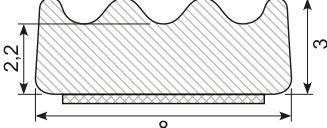
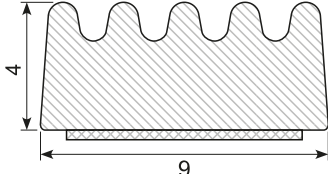
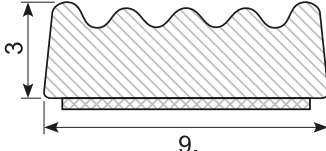
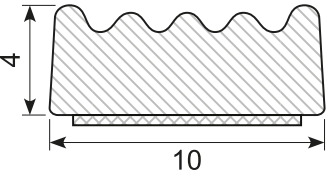
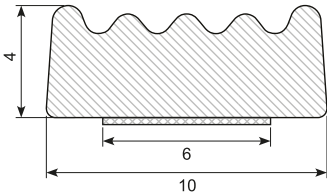
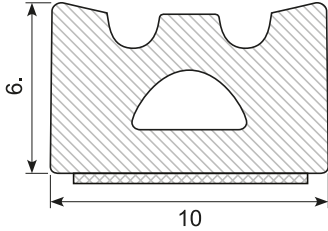
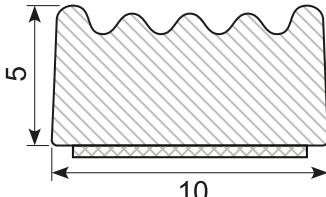
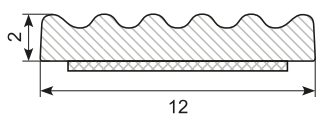
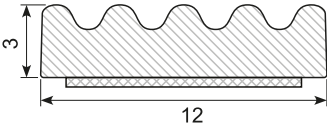
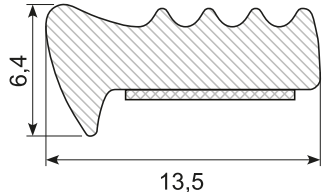
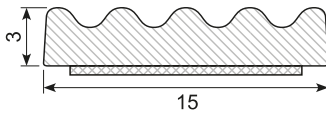
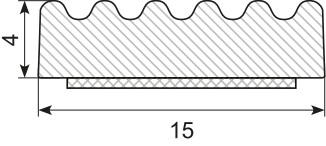
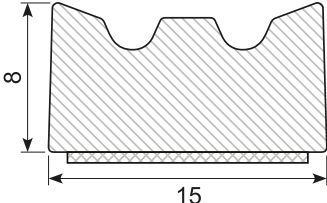
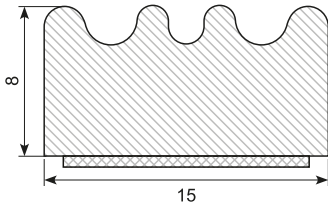
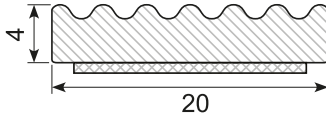
<p>36.720802</p>  <p>Material: EPDM, black Density: 0,35 - 0,45 Med klæb <i>With adhesive</i></p>	<p>36.720803</p>  <p>Material: EPDM, black Density: 0,35 - 0,45 Med klæb <i>With adhesive</i></p>	<p>36.720904</p>  <p>Material: EPDM, black Density: 0,35 - 0,45 Med klæb <i>With adhesive</i></p>	<p>36.720903</p>  <p>Material: EPDM, black Density: 0,35 - 0,45 Med klæb <i>With adhesive</i></p>
<p>36.721004</p>  <p>Material: EPDM, black Density: 0,35 - 0,45 Med klæb <i>With adhesive</i></p>	<p>36.721004-6</p>  <p>Material: EPDM, black Density: 0,35 - 0,45 Med smal 6 mm klæb <i>With narrow 6 mm adhesive</i></p>	<p>36.721006</p>  <p>Material: EPDM, black Density: 0,35 - 0,45 Med klæb <i>With adhesive</i></p>	<p>36.721005</p>  <p>Material: EPDM, black Density: 0,35 - 0,45 Med klæb <i>With adhesive</i></p>
<p>36.721202</p>  <p>Material: EPDM, black Density: 0,35 - 0,45 Med klæb <i>With adhesive</i></p>	<p>36.721203</p>  <p>Material: EPDM, black Density: 0,35 - 0,45 Med klæb <i>With adhesive</i></p>	<p>36.7213564</p>  <p>Material: EPDM, black Density: 0,35 - 0,45 Med klæb <i>With adhesive</i></p>	<p>36.721503</p>  <p>Material: EPDM, black Density: 0,35 - 0,45 Med klæb <i>With adhesive</i></p>
<p>36.721504</p>  <p>Material: EPDM, black Density: 0,35 - 0,45 Med klæb <i>With adhesive</i></p>	<p>36.721508</p>  <p>Material: EPDM, black Density: 0,35 - 0,45 Med klæb <i>With adhesive</i></p>	<p>36.721508B</p>  <p>Material: EPDM, black Density: 0,25 - 0,35 Med klæb <i>With adhesive</i></p>	<p>36.722004</p>  <p>Material: EPDM, black Density: 0,35 - 0,45 Med klæb <i>With adhesive</i></p>

Cellegummi

Cellular rubber

Cellegummi er ekstruderet, og når det produceres gør tilsætningen af gas, at der opstår en fuldstændig ensartet cellestruktur - også i overfladen.

Vi har meget lave tolerancer på cellegummi, som gør det meget anvendeligt i industrien med specialklæber. Cellegummi findes i gummityperne EPDM og CR.

Cellular rubber is extruded. During production, the addition of gas results in a completely uniform cell structure - also on the surface.

Our cellular rubber has very low tolerances. Therefore it is often used in industry with special glue. Available in EPDM and CR.



Sicocell

Material: EPDM, sort *black*

Hardness: SH 25

Density: 0,14

Med klæb *With adhesive*

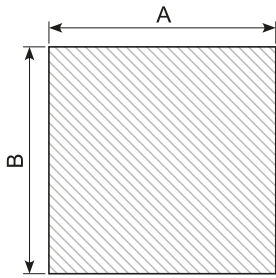

Varenr. <i>Item no.</i>	A x B	Varenr. <i>Item no.</i>	A x B	Varenr. <i>Item no.</i>	A x B	Varenr. <i>Item no.</i>	A x B
36.60403	4 x 3 mm	36.61008	10 x 8 mm	36.61603	16 x 3 mm	36.63005	30 x 5 mm
36.60404	4 x 4 mm	36.61010	10 x 10 mm	36.61710	17 x 10 mm	36.63010	30 x 10 mm
36.60503	5 x 3 mm	36.61203	12 x 3 mm	36.61808 *	18 x 8 mm	36.63012	30 x 12 mm
36.60505	5 x 5 mm	36.61204 *	12 x 4 mm	36.62002	20 x 2 mm	36.64003	40 x 3 mm
36.60605 *	6 x 5 mm	36.61205 *	12 x 5 mm	36.62003	20 x 3 mm	36.64005	40 x 5 mm
36.60802	8 x 2 mm	36.61310	13 x 10 mm	36.62004	20 x 4 mm	36.64010	40 x 10 mm
36.60803	8 x 3 mm	36.61502 *	15 x 2 mm	36.62005	20 x 5 mm	36.64015	40 x 15 mm
36.60804	8 x 4 mm	36.61503	15 x 3 mm	36.62008	20 x 8 mm	36.64020	40 x 20 mm
36.60805 *	8 x 5 mm	36.61505	15 x 5 mm	36.62010	20 x 10 mm	36.65003	50 x 3 mm
36.60808	8 x 8 mm	36.61506	15 x 6 mm	36.62020	20 x 20 mm	36.65010	50 x 10 mm
36.61001	10 x 1 mm	36.61508	15 x 8 mm	36.62305 *	23 x 5 mm	36.66002	60 x 2 mm
36.61002	10 x 2 mm	36.61510	15 x 10 mm	36.62502	25 x 2 mm	36.66004 *	60 x 4 mm
36.61003	10 x 3 mm	36.61512	15 x 12 mm	36.62506	25 x 6 mm	36.66004X *	60 x 4 mm
36.61004	10 x 4 mm	36.61518	15 x 18 mm	36.62510	25 x 10 mm	36.67502 *	75 x 2 mm
36.61005	10 x 5 mm	36.61530 *	15 x 30 mm	36.62525 *	25 x 25 mm		

Sicocell

Material:

- **CR:** med standard klæb *with standard adhesive*
- **CR-5952:** tape uden glasfiber *tape without glassfiber*

Hardness: SH 25

Density: 0,14

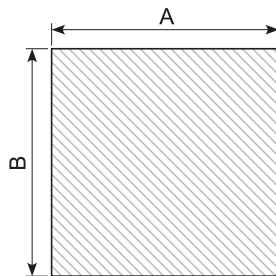

Varenr. <i>Item no.</i>	A x B	Varenr. <i>Item no.</i>	A x B	Varenr. <i>Item no.</i>	A x B
36.60802CR	8 x 2 mm	36.62002CR *	20 x 2 mm	36.63204CR *	32 x 4 mm
36.60804CR	8 x 4 mm	36.62004CR *	20 x 4 mm	36.64004CR *	40 x 4 mm
36.60808CR *	8 x 8 mm	36.2005CR *	20 x 5 mm	36.64005CR *	40 x 5 mm
36.61003CR	10 x 3 mm	36.2502CR *	25 x 2 mm	36.65005CR *	50 x 5 mm
36.61010CR *	10 x 10 mm	36.62505CR *	25 x 5 mm	36.65005CR-5952 *	50 x 5 mm
36.61609CR *	16 x 9 mm	36.63005CR-5952 *	30 x 5 mm	36.65007CR *	50 x 7 mm
		36.63030CR *	30 x 30 mm	36.68005CR *	80 x 5 mm
				36.68005CR-5952 *	80 x 5 mm

Cellegummiplade *Cellular rubber plates*

Uden klæb *No adhesive*

Material: EPDM, sort *black*

Density: 0,12

Varenr. <i>Item no.</i>	Tykkelse <i>Thickness</i>	Vidde <i>Width</i>	Længde <i>Length</i>
38.27700002	2 mm	20.000 mm	1.000 mm
38.27700003	3 mm	20.000 mm	1.000 mm
38.27700004	4 mm	20.000 mm	1.000 mm
38.27700005	5 mm	20.000 mm	1.000 mm
38.27700006	6 mm	20.000 mm	1.000 mm
38.27700008	8 mm	20.000 mm	1.000 mm
38.27700010	10 mm	20.000 mm	1.000 mm
38.27700015	15 mm	10.000 mm	1.000 mm
38.27700020	20 mm	10.000 mm	1.000 mm
38.27700025	25 mm	2.000 mm	1.000 mm
38.188 *	40 mm	2.000 mm	1.000 mm
38.189 *	50 mm	2.000 mm	1.000 mm

Cellegummiplade *Cellular rubber plates*

Med klæb *With adhesive*

Material: EPDM, sort *black*

Varenr. <i>Item no.</i>	Tykkelse <i>Thickness</i>	Vidde <i>Width</i>	Længde <i>Length</i>
38.160E/K *	1.000 mm	10 mm	2.000 mm
38.170E/K *	1.000 mm	20 mm	2.000 mm
38.175E/K *	1.000 mm	25 mm	2.000 mm

Cellegummiplade *Cellular rubber plates*

Material: CR, sort *black*

Varenr. <i>Item no.</i>	Tykkelse <i>Thickness</i>	Vidde <i>Width</i>	Længde <i>Length</i>
38.190 *	1.000 mm	10 mm	1.400 mm
38.191 *	1.000 mm	15 mm	1.400 mm

* Skaffevare *Special order item*

Sico trim

Sico trim

Trimlister (bedre kendt som pyntelister) kender vi fra bildøre og bagklapper på biler. De er også udbredt især i servicefaget, hvor man f.eks. på hoteller og i sundhedssektoren anvender dem som beskyttelse mod skader på døre, karme og vægge.

De er også kendt som eksklusive afslutningslister, som både er dekorative og beskytter mod buler. Vi kan tilbyde et bredt spekter og har langt mere, end der er vist her.

We know trims from car doors and hatches. But they are also widely used in the service industry, such as hotels and the healthcare sector, where it's used to protect doors and walls from damage.

They can also be used as exclusive end trims which is decorative, but also protective against dents. We have a wide range and have many more products than shown in this catalog.

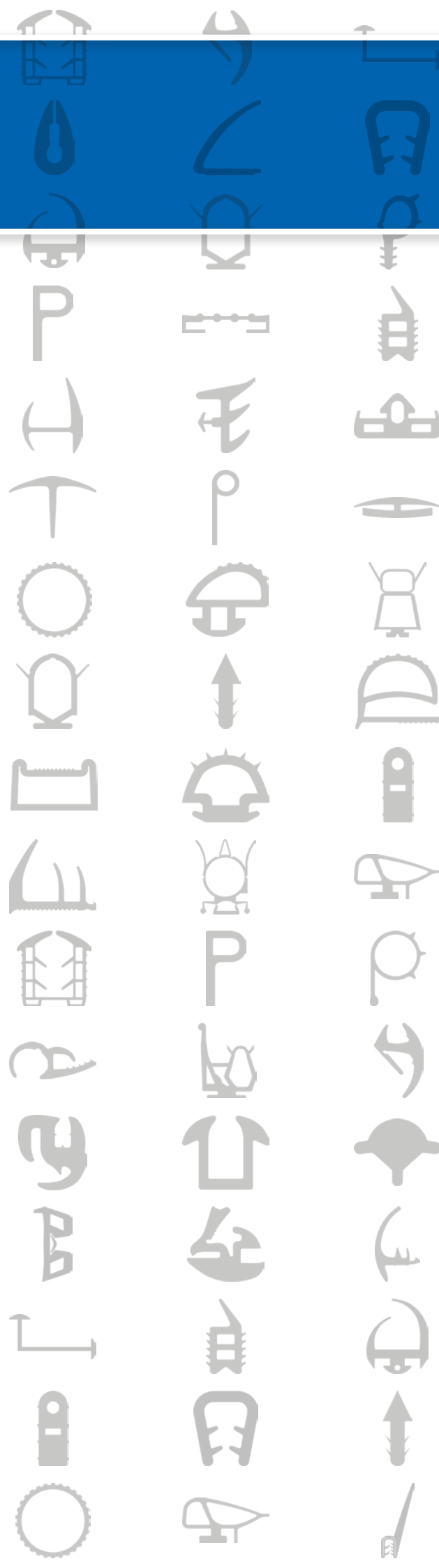

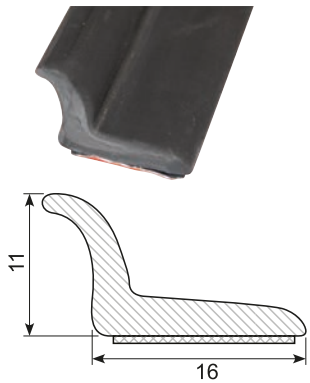
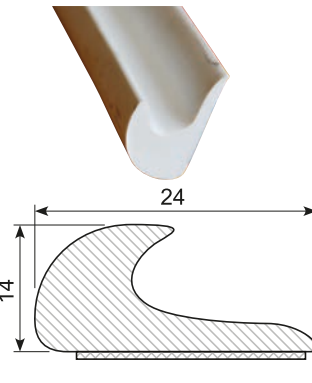
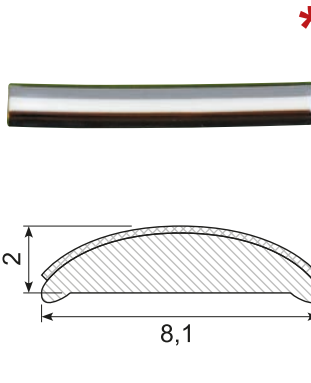
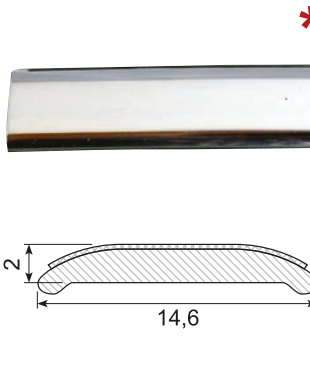
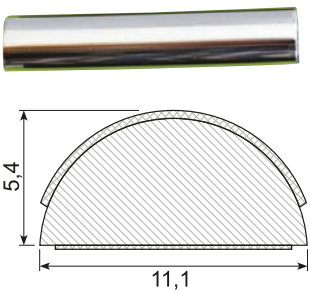
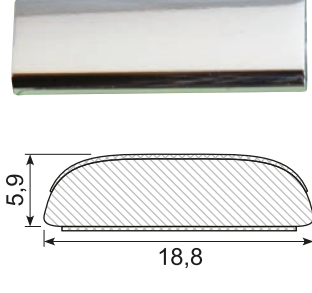
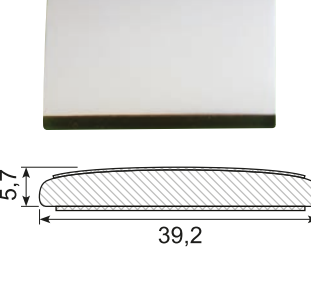
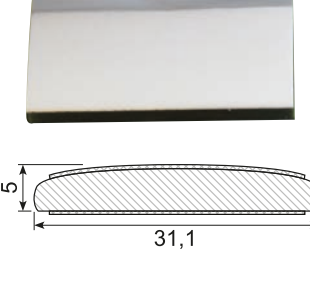
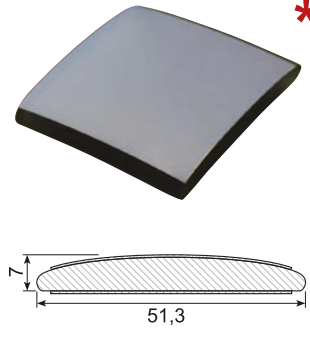
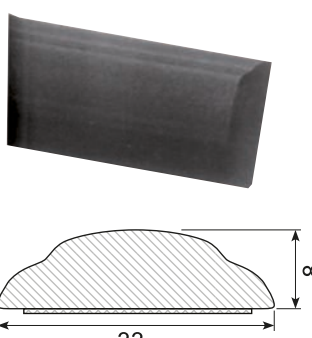
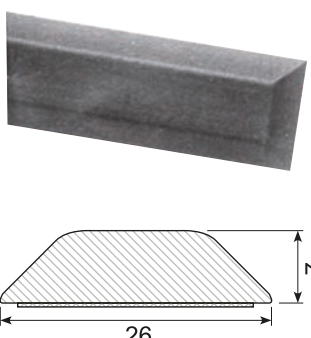
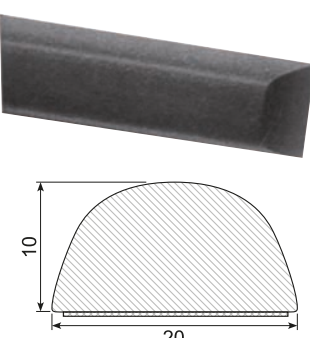
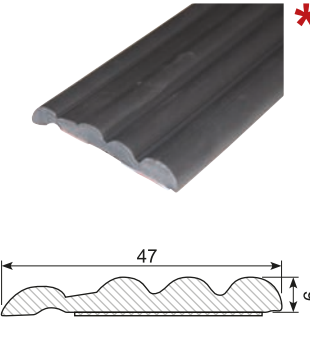
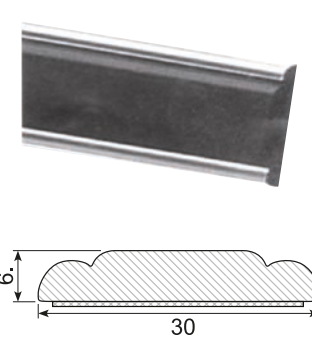
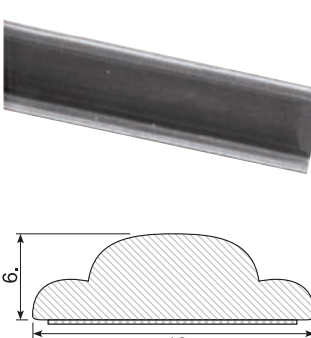
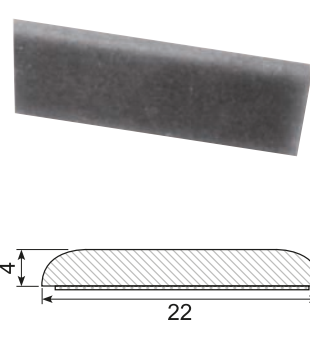
<p>45.206AL</p>  <p>Material: PVC Length: 2 m Med klæb <i>With adhesive</i></p>	<p>45.224</p>  <p>Material: PVC, white Length: 25 m Med klæb <i>With adhesive</i></p>	<p>45.217C *</p>  <p>Material: PVC, chrome Length: 5 m Med klæb <i>With adhesive</i></p>	<p>45.221C *</p>  <p>Material: PVC, chrome Length: 5 m Med klæb <i>With adhesive</i></p>
<p>45.347C *</p>  <p>Material: PVC, chrome Length: 5 m Med klæb <i>With adhesive</i></p>	<p>45.884C *</p>  <p>Material: PVC, chrome Length: 5 m Med klæb <i>With adhesive</i></p>	<p>45.383C *</p>  <p>Material: PVC, chrome Length: 5 m Med klæb <i>With adhesive</i></p>	<p>45.388C *</p>  <p>Material: PVC, chrome Length: 5 m Med klæb <i>With adhesive</i></p>
<p>45.705C *</p>  <p>Material: PVC, chrome Length: 5 m Med klæb <i>With adhesive</i></p>	<p>45.832</p>  <p>Material: PVC Length: 25 m Med klæb <i>With adhesive</i></p>	<p>45.836</p>  <p>Material: PVC Length: 25 m Med klæb <i>With adhesive</i></p>	<p>45.837</p>  <p>Material: PVC Length: 25 m Hardness: SH 74 - 76 Density: 1,32 Med klæb <i>With adhesive</i></p>
<p>45.839 *</p>  <p>Material: PVC Length: 25 m Med klæb <i>With adhesive</i> Min. order: 300 m</p>	<p>45.872</p>  <p>Material: PVC Length: 25 m Med klæb <i>With adhesive</i></p>	<p>45.874</p>  <p>Material: PVC Length: 25 m Med klæb <i>With adhesive</i></p>	<p>45.882</p>  <p>Material: PVC Length: 50 m Med klæb <i>With adhesive</i></p>

* Skaffevare Special order item

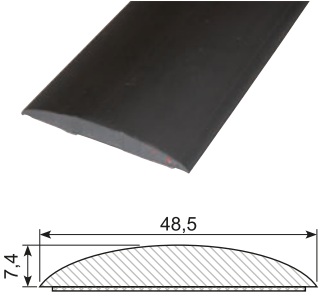
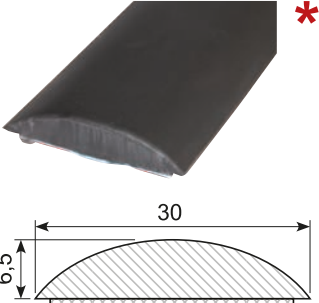
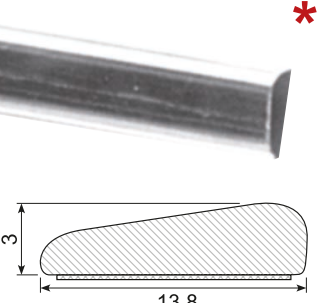
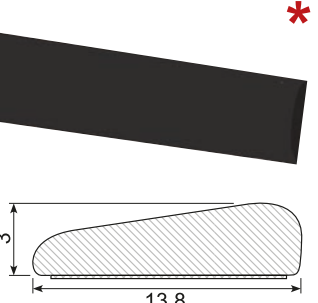
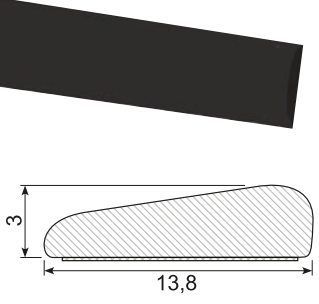
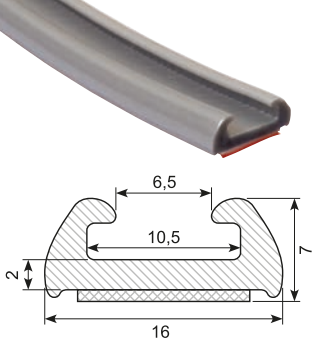
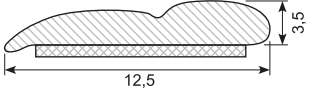
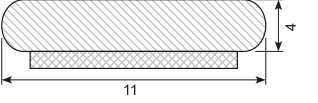
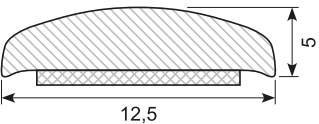
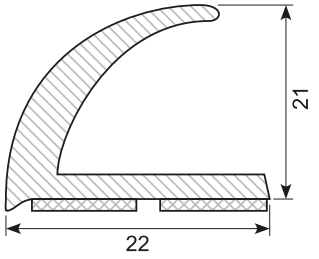
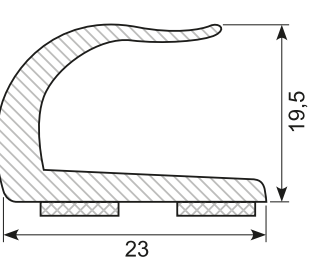
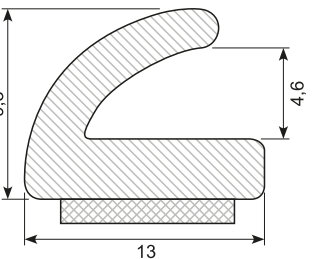
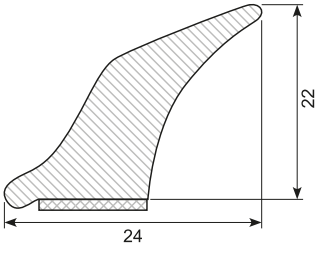
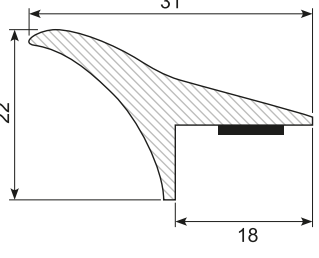
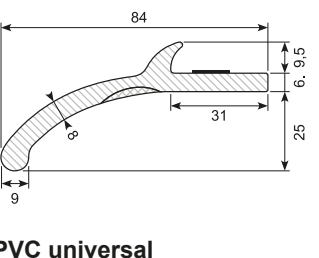
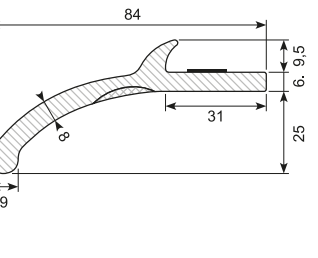
<p>45.886 / 45.886G</p>  <p>Material: PVC, black Length: 25 m Med klæb <i>With adhesive</i> 45.886G: Grey</p>	<p>45.894 *</p>  <p>Material: PVC Length: 25 m Med klæb <i>With adhesive</i> Min. order: 300 m</p>	<p>45.980A *</p>  <p>Material: PVC, chrome Length: 25 m Med klæb <i>With adhesive</i> Min. order: 500 m</p>	<p>45.980K *</p>  <p>Material: PVC Length: 340 mm Med klæb <i>With adhesive</i> Example fix lengths Min. order: 1.400 pcs.</p>
<p>45.980S *</p>  <p>Length: 25 m Min. order: 500 m</p>	<p>45.102G</p>  <p>Length: 25 m For LED lysstrips For LED light strips</p>	<p>45.308C / 45.308C-50 *</p>  <p>Material: PVC, chrome Length: 5 m 45.308C-50: 50 m Min. order: 300 m</p>	<p>45.309C / 45.309C-50 *</p>  <p>Material: PVC, chrome Length: 5 m 45.309C-50: 50 m Min. order: 300 m</p>
<p>45.216C-50 *</p>  <p>Material: PVC, chrome Length: 50 m Min. order: 300 m</p>	<p>45.123 *</p>  <p>Material: PVC Length: 25 m Med klæb <i>With adhesive</i> Min. order: 300 m</p>	<p>45.393 *</p>  <p>Material: PVC Length: 25 m Med klæb <i>With adhesive</i> Min. order: 300 m</p>	<p>45.394 *</p>  <p>Material: PVC Length: 25 m Med klæb <i>With adhesive</i> Min. order: 300 m</p>
<p>45.901 *</p>  <p>Rende Gutter Material: PVC Length: 25 m Med klæb <i>With adhesive</i> Min. order: 300 m</p>	<p>45.2031024 *</p>  <p>PVC universal hjulkassepanel PVC universal wheel arch panel Length: 1,5 m Sæt á 4 stk. Set of 4 pcs. Med klæb <i>With adhesive</i></p>	<p>45.20511046 *</p>  <p>PVC universal hjulkassepanel PVC universal wheel arch panel Color: Black Length: 6 m Rulle Coil Med klæb <i>With adhesive</i></p>	<p>45.20511091 *</p>  <p>PVC universal hjulkassepanel PVC universal wheel arch panel Length: 1,5 m Sæt á 4 stk. Set of 4 pcs. Med klæb <i>With adhesive</i></p>

* Skaffevare Special order item

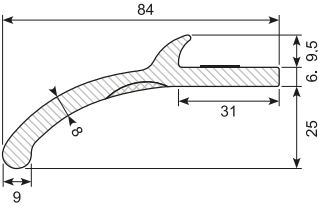
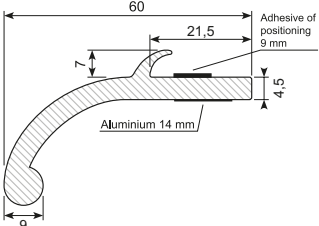
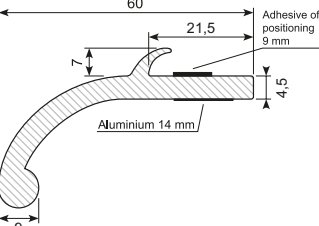
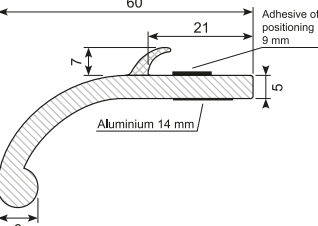
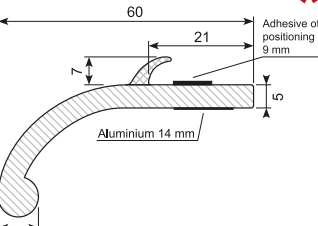
45.2051445	45.235N1057	45.235N429	45.235NG1057
 <p>PVC universal hjulkassepanel <i>PVC universal wheel arch panel</i> Length: 12,5 m Rulle <i>Coil</i> Med klæb <i>With adhesive</i></p>	 <p>PVC universal hjulkassepanel <i>PVC universal wheel arch panel</i> Color: Black Length: 6 m Rulle <i>Coil</i> Med klæb <i>With adhesive</i></p>	 <p>PVC universal hjulkassepanel <i>PVC universal wheel arch panel</i> Color: Black Length: 12,5 m Rulle <i>Coil</i> Med klæb <i>With adhesive</i></p>	 <p>PVC universal hjulkassepanel <i>PVC universal wheel arch panel</i> Color: Grey/black Length: 6 m Rulle <i>Coil</i> Med klæb <i>With adhesive</i></p>
<p>45.235NG429</p>  <p>PVC universal hjulkassepanel <i>PVC universal wheel arch panel</i> Color: Grey/black Length: 12,5 m Rulle <i>Coil</i> Med klæb <i>With adhesive</i></p>			

Gummibuffer

Rubber buffer

En gummibuffer sikrer en god afstand mellem to elementer og beskytter dem mod at ødelægge hinanden.

I privat brug kan de f.eks. anvendes som dørstop. I industrien ses de på læsseramper og ved maskinvogne. I det maritime bruger vi dem ved trailere og stativer til opmagasinering.

Vi fører også gummiklodser til autolifte.

A rubber buffer ensures a good distance between two elements, and also protects them from destroying each other.

At home they are used as doorstops. In industry they are used on loading ramps and machine trolleys. In maritime they are used by trailers and racks for storage.

We also have rubber blocks for car lifts in stock.

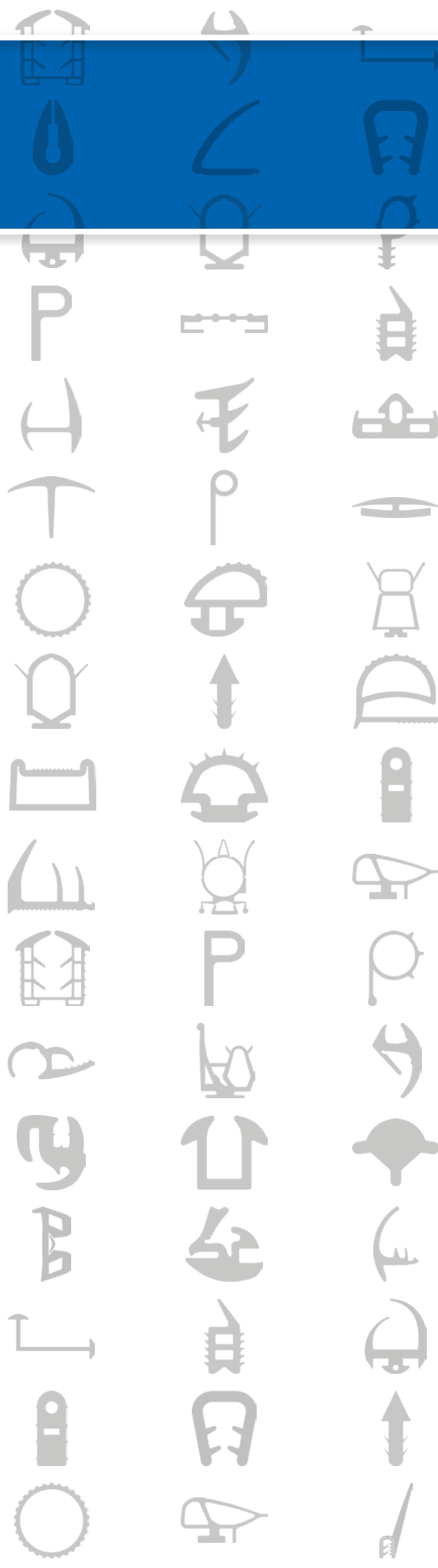

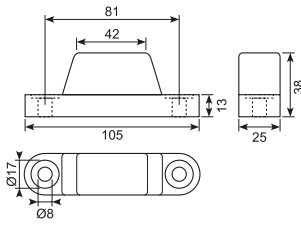
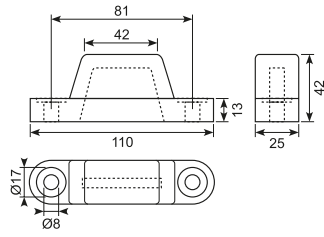
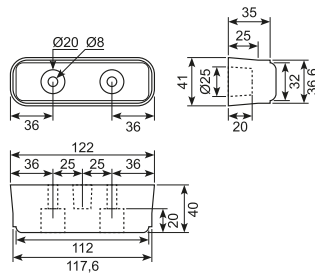
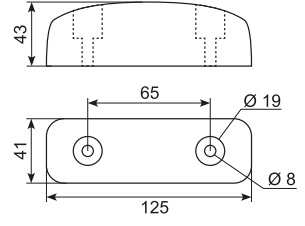
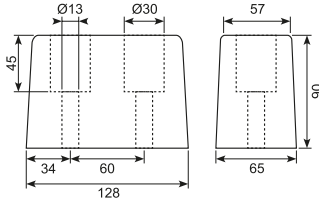
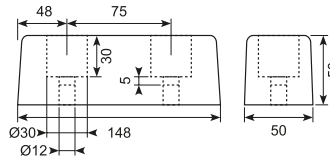
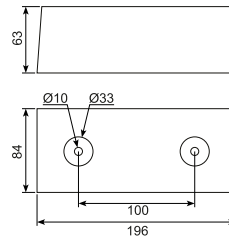
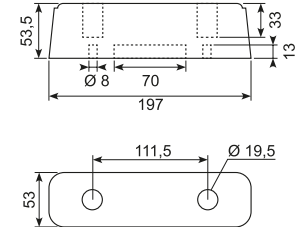
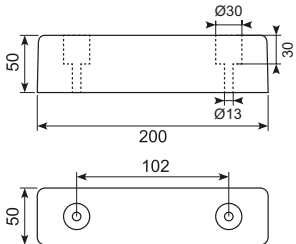
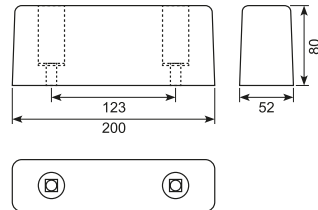
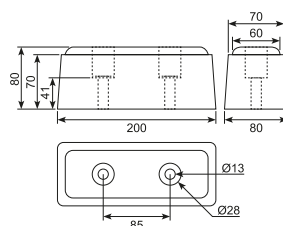
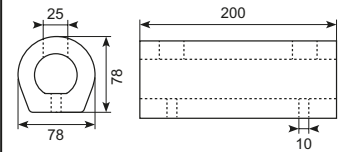
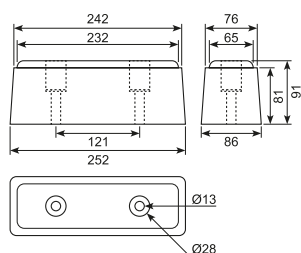
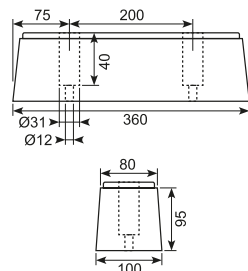
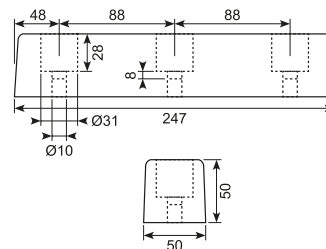
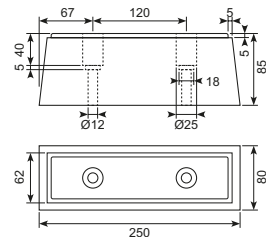

<p>56.7001-007</p>  <p>Rubber stopper Grey - Ral 7035</p>	<p>39.171J / 39.171G</p>  <p>Color: Black 39.171G: Light grey</p>	<p>39.175J</p>  <p>Material: NR, black Hardness: SH 78</p>	<p>39.175H</p>  <p>Material: NR, white Min. order: 2.000 pcs.</p>
<p>39.167G</p>  <p>Grå gummibuffer Grey rubber buffer Material: NR / SBR</p>	<p>39.168G</p>  <p>Grå gummibuffer Grey rubber buffer Material: NR / SBR</p>	<p>39.169G</p>  <p>Grå gummibuffer Grey rubber buffer Material: NR / SBR</p>	<p>39.170G</p>  <p>Grå gummibuffer Grey rubber buffer Material: NR / SBR</p>
<p>39.174</p> 	<p>39.177</p> 	<p>39.178</p> 	<p>39.179</p> 
<p>39.632J</p>  <p>Oval gummibuffer, sort Oval rubber buffer, black</p>	<p>39.632A</p>  <p>Material: NR / SBR, black</p>	<p>39.632B</p>  <p>Material: NR / SBR, black</p>	<p>39.632C</p>  <p>Material: NR / SBR, black</p>

* Skaffevare Special order item

39.172**Material:** NR / SBR, black**39.173****Material:** NR / SBR, black**39.626J****Material:** NR, black
Hardness: SH 85**39.637****Material:** NR / SBR, black**39.625****Material:** NR / SBR, black**39.624****Material:** NR / SBR, black**39.623J****Let konisk Slightly conical**
Material: NR, black**39.620J****Med skiver With washers**
Material: NR, black
Hardness: SH 85**39.638****Material:** NR / SBR, black**39.181061****Material:** NR / SBR, black
Weight: 1.050 g**39.181052****Material:** NR / SBR, black
Weight: 1.370 g**39.627****Material:** SBR, black**39.181060****Material:** NR / SBR, black
Weight: 1.370 g**39.360****Material:** NR / SBR, black**39.628****Material:** NR / SBR, black**39.646****Material:** NR / SBR, black
Weight: 1.800 g

<p>39.629</p> <p>Material: NR/SBR, black</p>	<p>39.634</p> <p>Med stålskiver og stålhus <i>With steel washers and steel casing. 3 holes for 16 mm bolt</i> Material: EPDM, black</p>	<p>39.630</p> <p>Material: NR/SBR, black</p>	<p>39.634P</p> <p>Material: NR/SBR, black</p>
<p>39.647 *</p> <p>Material: NR/SBR, black</p>	<p>39.650</p> <p>Material: NR/SBR, black</p>	<p>39.631X</p> <p>Material: SBR, black Hardness: SH 66</p>	<p>39.651A / 39.651 *</p> <p>Material: NR/SBR 39.651: SBR & rayon</p>
<p>39.652</p> <p>Material: NR/SBR, black</p>	<p>39.653</p> <p>Material: NR/SBR, black</p>	<p>39.644 / 39.644A *</p> <p>Material: SBR & rayon 39.644A*: NR/SBR</p>	<p>39.631A *</p> <p>Material: NR/SBR</p>
<p>39.648</p> <p>Material: NR/SBR, black</p>	<p>39.649 *</p> <p>Material: NR/SBR, black</p>	<p>39.642X / 39.642</p> <p>Material: NR/SBR (Economy) 39.642: SBR & rayon</p>	<p>39.643X</p> <p>Material: NR/SBR (Economy)</p>

* Skaffevare Special order item

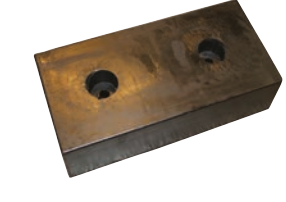
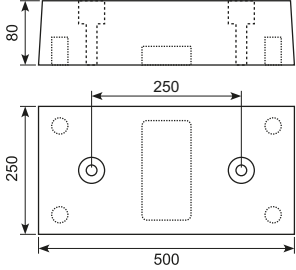
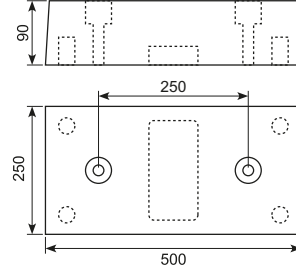
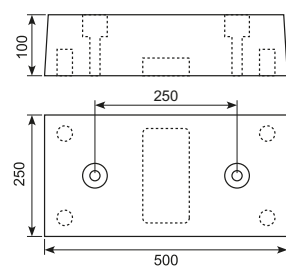
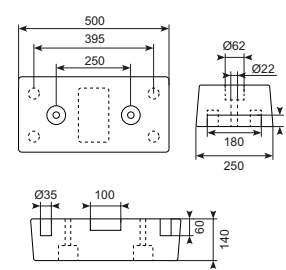
39.635X	39.635	39.636X	39.636
			
			
Vulkaniseret nyt gummi <i>Vulcanized new rubber</i>	Vulkaniseret nyt gummi <i>Vulcanized new rubber</i>	Vulkaniseret nyt gummi <i>Vulcanized new rubber</i>	Vulkaniseret nyt gummi <i>Vulcanized new rubber</i>

Anslagsbuffere *Tipper pads*

Material: Stål / gummi *Steel / rubber*



Varenr. <i>Item no.</i>	Størrelse stålelement <i>Size steel element</i>	Størrelse gummielement <i>Size rubber element</i>	Vægt <i>Weight</i>
39.658	150 x 40 x 5 mm	100 x 40 x 25 mm	0,34 kg
39.656	152 x 88 x 6 mm	100 x 86 x 22 mm	0,75 kg
39.657	355 x 75 x 3 mm	290 x 74 x 27 mm	1,35 kg

Anslagsbuffere *Tipper pads*

Material: Stål / gummi *Steel / rubber*



Varenr. <i>Item no.</i>	Størrelse stålelement <i>Size steel element</i>	Størrelse gummielement <i>Size rubber element</i>	Vægt <i>Weight</i>
39.659 *	152 x 88 x 5 mm	100 x 86 x 23 mm	0,41 kg
39.660 *	152 x 88 x 5 mm	100 x 88 x 38 mm	0,6 kg
39.661 *	180 x 75 x 5 mm	115 x 75 x 29 mm	0,41 kg
39.662 *	180 x 75 x 5 mm	150 x 75 x 40 mm	0,6 kg
39.663 *	180 x 75 x 4 mm	115 x 75 x 46 mm	0,6 kg
39.664 *	190 x 115 x 6 mm	120 x 112 x 14 - 20 mm	0,6 kg
39.665 *	355 x 75 x 5 mm	290 x 75 x 39 mm	1,4 kg

39.180	39.181	39.182	39.183
 <p>Gummipude til liftstabilisatorer <i>Rubber pad for lift stabilizers</i> Size: Ø120 x H 26 mm Internal: Ø108 mm Material: SBR, black Hardness: SH 80</p>	 <p>Gummipude til liftstabilisatorer <i>Rubber pad for lift stabilizers</i> Size: Ø120 x H 26 mm Internal: Ø108 mm Material: SBR, black Hardness: SH 75</p>	 <p>Gummipude til liftstabilisatorer <i>Rubber pad for lift stabilizers</i> Size: Ø145 x H 24 mm Internal: Ø120 mm Material: SBR, black Hardness: SH 75</p>	 <p>Gummipude til liftstabilisatorer <i>Rubber pad for lift stabilizers</i> Size: Ø145 x H 26 mm Internal: Ø135 mm Material: TPE, black Hardness: SH 80</p>
39.183A	39.183B	39.183C	39.188
 <p>Gummipude til liftstabilisatorer <i>Rubber pad for lift stabilizers</i> Material: SBR, black Size: Ø100 x H 21 mm Internal: Ø80 mm Hardness: SH 80</p>	 <p>Gummipude til liftstabilisatorer <i>Rubber pad for lift stabilizers</i> Material: SBR, black Size: Ø140 x H 25 mm Internal: Ø103 mm Hardness: SH 80</p>	 <p>Gummipude til liftstabilisatorer <i>Rubber pad for lift stabilizers</i> Material: Black Size: Ø140 x H 25 mm Internal: Ø74 / 60 mm Hardness: SH 80</p>	 <p>Gummipude til liftstabilisatorer <i>Rubber pad for lift stabilizers</i> Material: SBR, black Size: Ø160 x H 28 mm Internal: Ø135 mm Hardness: SH 75</p>
39.184	39.185	39.186	39.187
 <p>Gummipude til liftstabilisatorer <i>Rubber pad for lift stabilizers</i> Material: SBR, black Hardness: SH 75 Size: 160 x 120 x 20 mm</p>	 <p>Gummipude til liftstabilisatorer <i>Rubber pad for lift stabilizers</i> Material: SBR, black Hardness: SH 75 Size: 160 x 120 x 35 mm</p>	 <p>Gummipude til liftstabilisatorer <i>Rubber pad for lift stabilizers</i> Material: SBR, black Hardness: SH 75 Size: 160 x 120 x 120 mm</p>	 <p>Gummipude til liftstabilisatorer <i>Rubber pad for lift stabilizers</i> Material: SBR, black Hardness: SH 75 Size: 180 x 60 x 100 mm</p>

* Skaffevare Special order item

39.M24

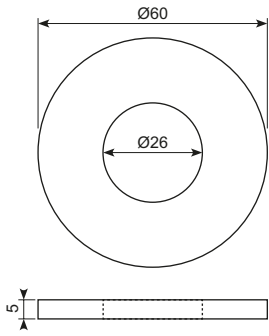

M24-skive til gummibuffer
M24 washer for rubber buffer

52.CWC8

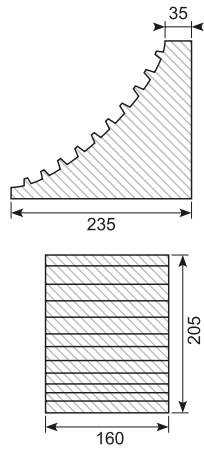

Stopklods
Stop block

39.645

Stopper for palleløfter *Stopper for pallet jack*
 Material: NBR / SBR
 Weight: 5,8 kg

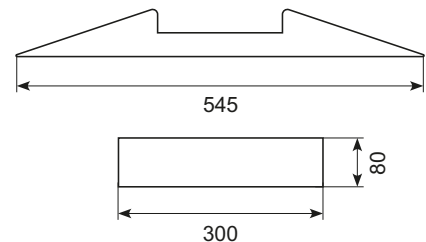
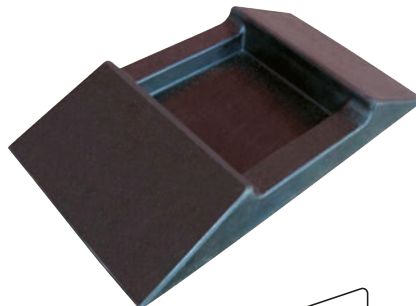

* Skaffevare *Special order item*

Vibrationsdæmpere

Vibration muffler

For ikke at sprede en maskines rystelser til gulvet og andre omgivelser, kan man med fordel montere maskinen på vibrationsdæmpere.

Om end du vil skåne en bygning, maskine eller mennesker for skader, stød, støj og belastninger, kan du finde de rette vibrationsdæmpere i vores udvalg.

Udover de viste har vi adgang til et stort udvalg af gummifødder og svingningsdæmpere i mange forskellige mål og med forskellige gevind.

In order not to spread the vibrations of a machine to the floor and other environments, it is beneficial to mount the machine on vibration mufflers.

If you want to protect and shield a building, a machine or people from injuries, shocks, noises and loads, you will certainly find the right vibration muffler in our selection.

In addition to the vibration mufflers shown in this catalog, we have a wide selection of rubber feet and vibration dampers with many different sizes and threads.

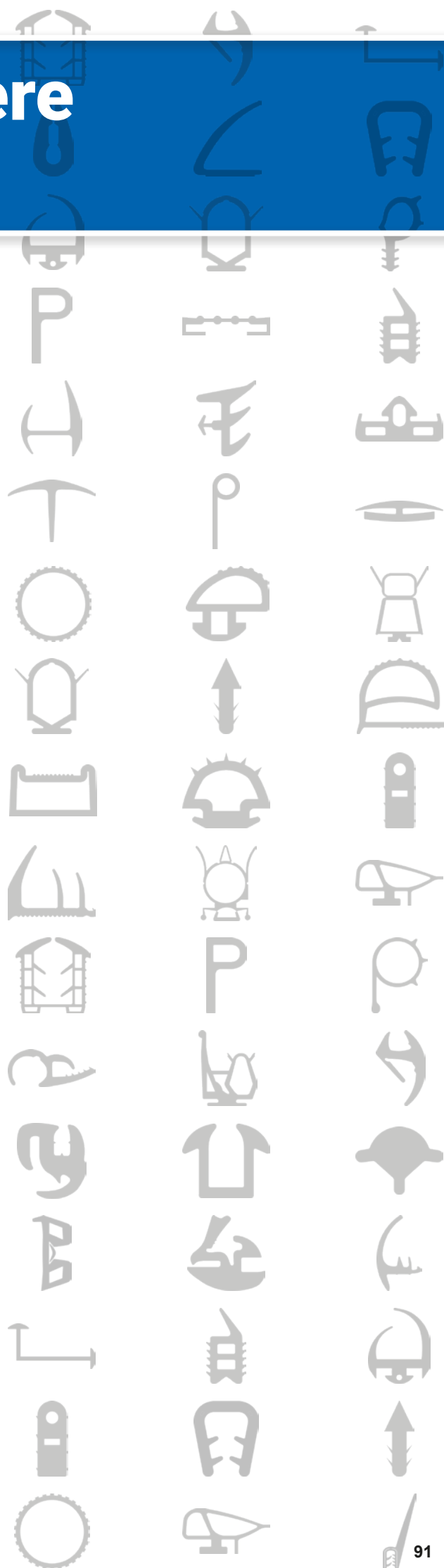

TYPE M

Flere størrelser kan skaffes på bestilling

More sizes available on request

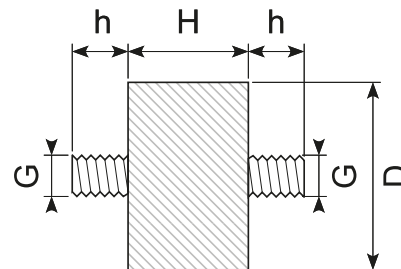

Varenr. <i>Item no.</i>	Hårdhed <i>Hardness</i>	D	H	h	G	Bemærk <i>Note</i>
39.M9/12-43	SH 43	9	12	8	M4	
39.M10/10	SH 57	10	10	10	M4	
39.M15/15	SH 57	15	15	10	M4	
39.M1810	SH 55	18	10	12	M6	
39.M20/8-M6	SH 55	20	8	18	M6	
39.M20/10-M6	SH 55	20	10	18	M6	
39.M20/10	SH 55	20	10	18	M8	
39.M2015	SH 55	20	15	18	M6	
39.M20/15-A4	SH 55	20	15	18	M6	A4: Rustfri <i>Stainless</i>
39.M2020-M6-45	SH 43	20	20	15	M6	
39.M20/20-A2	SH 55	20	20	18	M6	A2: Rustfri <i>Stainless</i>
39.M2020	SH 55	20	20	18	M6	
39.M2020-M8	SH 55	20	20	18	M8	
39.M25/10-M6ESD	SH 55	25	10	18	M6	ESD
39.M25/10-M8	SH 55	25	10	10	M8	
39.M25/10-M8x10/20	SH 55	25	10	10 / 20	M8	
39.M2515	SH 55	25	15	18	M6	
39.M2515-55	SH 55	25	15	18	M8	
39.M2520-M6	SH 55	25	20	18	M6	
39.M2520	SH 55	25	20	18	M8	
39.M25/22	SH 55	25	22	10	M8	
39.M30/10	SH 55	30	10	23	M8	
39.M3015-M8x15	SH 55	30	15	15	M8	
39.M3015	SH 55	30	15	23	M8	
39.M30/20XX	SH 68	30	20	6 / 12	M8	
39.M3020-55	SH 55	30	20	23	M8	
39.M3020	SH 65	30	20	23	M8	
39.M3030-SS	SH 57	30	30	10	M8	A2: Rustfri <i>Stainless</i>
39.M3030	SH 55	30	30	23	M8	
39.M40/20	SH 55	40	20	23	M8	
39.M4025	SH 55	40	25	23	M8	
39.M4030	SH 55	40	30	23	M8	
39.M4038	SH 55	40	38	23	M8	
39.M40/38-M12	SH 55	40	38	23	M12	
39.M40/40	SH 55	40	40	28	M10	
39.M40/40-A2	SH 55	40	40	28	M10	A2: Rustfri <i>Stainless</i>
39.M40/50-A2	SH 43	40	50	33 / 23	M10	A2: Rustfri <i>Stainless</i>
39.M50/20-M10X	SH 55	50	20	12 / 20	M10	
39.M50/20NBR	SH 55	50	20	33	M10	
39.M5025	SH 55	50	25	28	M10	
39.M50/30-A2	SH 55	50	30	28	M10	
39.M5030	SH 55	50	30	33	M10	
39.M50/30NBR	SH 55	50	30	33	M10	
39.M5040	SH 55	50	40	25	M12	
39.M5045	SH 65	50	45	27	M10	
39.M5050	SH 55	50	50	28	M10	
39.M6035	SH 55	60	35	25	M12	
39.M6050	SH 55	60	50	28	M10	
39.M7540	SH 55	75	40	37	M12	
39.M7550	SH 55	75	50	37	M12	
39.M7560	SH 55	75	60	33	M12	
39.M8050	SH 55	80	50	37	M12	
39.M100/50NBR	SH 55	100	50	41	M16	
39.M100/55-40	SH 40	100	55	42	M14	

TYPE B

Flere størrelser kan skaffes på bestilling

More sizes available on request

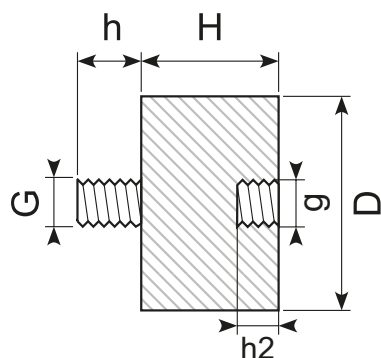
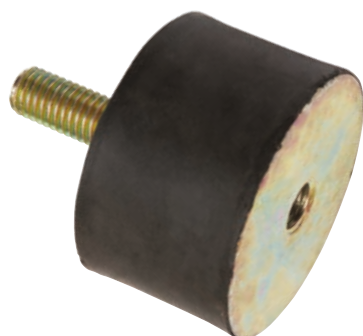

Varenr. <i>Item no.</i>	Hårdhed <i>Hardness</i>	D	H	h	h2	G	g	Bemærk <i>Note</i>
39.B08/08-43	SH 43	8	8	6	3	M3	M3	
39.B10/10	SH 57	10	10	10	4	M4	M4	
39.B15/10	SH 57	15	10	8	5	M5	M5	
39.B15/15-M4x8	SH 57	15	15	8	4	M4	M4	
39.B15/15-M5x10	SH 60	15	15	10	5	M5	M5	
39.B15/15-R11	SH 60	15	15	10	5	M5	M5	R11
39.B15/15	SH 55	15	15	10	6	M6	M6	
39.B16/18	SH 55	16	18	10	5	M5	M5	
39.B20/10-M6	SH 55	20	10	18	6	M6	M6	
39.B20/10	SH 55	20	10	18	8	M8	M8	
39.B20/15-M6-43	SH 43	20	15	10	6	M6	M6	
39.B20/15-M6	SH 57	20	15	10	6	M6	M6	
39.B20/15-A4	SH 55	20	15	18	6	M6	M6	
39.B20/15	SH 55	20	15	18	8	M8	M8	
39.B20/20-M6-43	SH 43	20	20	10	6	M6	M6	
39.B20/20-M6x15-43	SH 43	20	20	15	6	M6	M6	
39.B20/20-M6	SH 57	20	20	10	6	M6	M6	
39.B2020	SH 55	20	20	18	8	M8	M8	
39.B20/25-M6	SH 55	20	25	18	6	M6	M6	
39.B2513	SH 55	25	13	18	6	M6	M6	
39.B25/25-M6	SH 55	25	25	18	6	M6	M6	
39.B25/25	SH 55	25	25	18	8	M8	M8	
39.B25/30	SH 55	25	30	18	6	M6	M6	
39.B30/20-M6x10-43	SH 43	30	20	10	6	M6	M6	
39.B30/20-M6x10-57	SH 57	30	20	10	6	M6	M6	
39.B30/20XXX	SH 55	30	20	8	8	M8	M8	
39.B30/20XX	SH 68	30	20	12	8	M8	M8	
39.B30/20X	SH 55	30	20	20	8	M8	M8	
39.B30/20	SH 55	30	20	33	8	M8	M8	
39.B30/20NBR	SH 55	30	20	33	8	M8	M8	
39.B30/25-43	SH 43	30	25	15	8	M8	M8	
39.B30/30-M6	SH 55	30	30	20	6	M6	M6	
39.B30/30-M6-M8x23	SH 55	30	30	23	8	M8	M6	
39.B3030	SH 55	30	30	23	8	M8	M8	
39.B30/40	SH 55	30	40	20	8	M8	M8	
39.B40/20	SH 55	40	20	23	8	M8	M8	
39.B40/30-M8x10-43	SH 43	40	30	10	8	M8	M8	
39.B40/30	SH 55	40	30	23	8	M8	M8	
39.B40/35	SH 55	40	35	23	8	M8	M8	
39.B50/20-M8	SH 55	50	20	15	8	M8	M8	
39.B50/25	SH 55	50	25	28	10	M10	M10	
39.B50/30	SH 55	50	30	28	10	M10	M10	
39.B50/40-43	SH 43	50	40	10	10	M10	M10	
39.B50/40	SH 57	50	40	28	10	M10	M10	
39.B50/50-M10	SH 55	50	50	28	10	M10	M10	
39.B50/50	SH 55	50	50	28	12	M12	M12	
39.B60/30	SH 55	60	30	25	12	M12	M12	
39.B60/40	SH 68	60	40	25	12	M12	M12	
39.B60/45-A2	SH 55	60	45	23	12	M12	M12	A2: Rustfri Stainless
39.M60/50	SH 55	60	50	28	10	M10	M10	
39.B75/30	SH 55	75	30	25	12	M12	M12	
39.B75/40-M8x18X	SH 55	75	40	18	8	M8	M8	
39.B75/40-M10x18	SH 55	75	40	18	10	M10	M10	
39.B75/40	SH 55	75	40	25	12	M12	M12	
39.B75/40-M12x40	SH 55	75	40	40	12	M12	M12	
39.B75/50	SH 55	75	50	25	12	M12	M12	
39.B100/30	SH 55	100	30	46	16	M16	M16	
39.B100/40	SH 55	100	40	46	16	M16	M16	
39.B100/50	SH 55	100	50	46	16	M16	M16	
39.B100/75	SH 43	100	75	46	16	M16	M16	
39.B100/75-55	SH 55	100	75	45	16	M16	M16	

TYPE C

Flere størrelser kan skaffes på bestilling
More sizes available on request

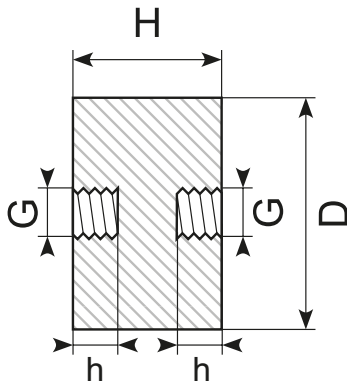
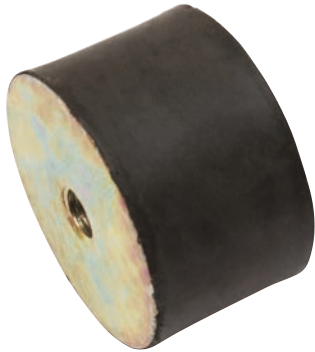

Varenr. <i>Item no.</i>	Hårdhed <i>Hardness</i>	D	H	h	G	Bemærk <i>Note</i>
39.C20/10	SH 55	20	10	4	M4	
39.C20/15	SH 57	20	15	6	M6	
39.C20/20	SH 55	20	20	6	M6	
39.C20/20-A4	SH 55	20	20	6	M6	A4: Syrefast <i>Acid proof</i>
39.C20/25-VMQ	SH 55	20	25	4	M4	Transparent silikone, A4: Syrefast <i>Acid proof</i>
39.C25/10	SH 55	25	10	4	M4	
39.C25/15	SH 55	25	15	6	M6	
39.C25/15-A2	SH 55	25	15	6	M6	A2: Rustfri <i>Stainless</i>
39.C25/25	SH 55	25	25	6	M6	
39.C25/25-M8	SH 55	25	25	8	M8	
39.C30/15	SH 55	30	15	8	M8	Åben indsats <i>Open insert</i>
39.C30/20	SH 55	30	20	8	M8	
39.C30/22	SH 55	30	22	8	M8	
39.C30/30-A4	SH 57	30	30	8	M8	A4: Syrefast <i>Acid proof</i>
39.C30/30	SH 65	30	30	8	M8	
39.C30/40	SH 55	30	40	8	M8	
39.C40/20	SH 55	40	20	8	M8	
39.C40/25	SH 55	40	25	8	M8	
39.C40/30	SH 55	40	30	8	M8	
39.C40/40	SH 55	40	40	8	M8	
39.C40/40-M10	SH 55	40	40	10	M10	
39.C40/50	SH 55	40	50	8	M8	
39.C40/50-68	SH 68	40	50	8	M8	
39.C50/20	SH 55	50	20	10	M10	
39.C50/25	SH 55	50	25	10	M10	
39.C50/30-M8	SH 55	50	30	8	M8	
39.C50/30	SH 55	50	30	10	M10	
39.C50/30-A2	SH 57	50	30	10	M10	A2: Rustfri <i>Stainless</i>
39.C50/30-68	SH 68	50	30	10	M10	
39.C50/35-43	SH 43	50	35	10	M10	
39.C50/35	SH 55	50	35	10	M10	
39.C50/40	SH 55	50	40	10	M10	
39.C50/40-M12	SH 55	50	40	12	M12	
39.C50/45	SH 55	50	45	10	M10	
39.C50/50	SH 57	50	50	10	M10	
39.C60/30-M8	SH 55	60	30	8	M8	
39.C60/30	SH 55	60	30	10	M10	
39.C60/40-M10	SH 43	60	40	10	M10	
39.C60/40-M12	SH 43	60	40	12	M12	
39.C60/40	SH 65	60	40	12	M12	
39.C60/45	SH 65	60	45	10	M10	
39.C65/35-M10	SH 55	65	35	10	M10	
39.C65/35	SH 55	65	35	12	M12	
39.C70/45-M10	SH 55	70	45	10	M10	
39.C70/50-A2	SH 55	70	50	12	M12	A2: Rustfri <i>Stainless</i>
39.C75/30-M10	SH 55	75	30	10	M10	
39.C75/30-M10-68	SH 68	75	30	10	M10	
39.C75/30	SH 55	75	30	12	M12	
39.C75/50	SH 57	75	50	12	M12	
39.C75/55-M10	SH 55	75	55	10	M10	
39.C75/55-43A	SH 43	75	55	12	M12	
39.C75/55	SH 55	75	55	12	M12	
39.C100/40	SH 65	100	40	16	M16	
39.C100/50	SH 55	100	50	16	M16	
39.C100/55NBR68	SH 68	100	55	16	M16	
39.C100/60-M12	SH 55	100	60	12	M12	
39.C100/75	SH 55	100	75	16	M16	
39.C150/40	SH 65	150	40	16	M16	
39.C150/75-M20	SH 55	150	75	20	M20	
39.C200/100	SH 55	200	100	20	M20	

TYPE D

Flere størrelser kan skaffes på bestilling
More sizes available on request

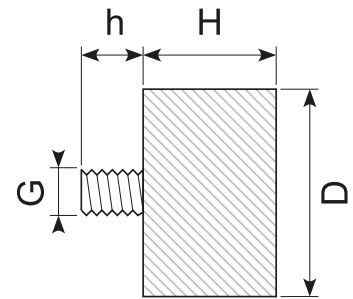

Varenr. <i>Item no.</i>	Hårdhed <i>Hardness</i>	D	H	h	G	Bemærk <i>Note</i>
39.D8/5	SH 55	8	5	6	M4	
39.D10/10	SH 55	10	10	10	M5	
39.D10/10-A2	SH 55	10	10	10	M5	A2: Rustfri <i>Stainless</i>
39.D13/13-M8x35	SH 68	13	13	38	M8	
39.D15/4G-M4x6	SH 68	15	4	6	M4	Grå <i>Grey</i> - RAL 7035
39.D15/10	SH 55	15	10	15	M5	
39.D15/10-M6	SH 55	15	10	18	M6	
39.D15/15	SH 55	15	15	15	M5	
39.D15/15-M6	SH 55	15	15	15	M6	
39.20/8-M8	SH 55	20	8	8	M8	
39.D20/10	SH 55	20	10	18	M6	
39.D20/10-A4	SH 55	20	10	18	M6	A4: Syrefast <i>Acid proof</i>
39.20/15-M5	SH 57	20	15	8	M5	
39.D20/15E	SH 55	20	15	15	M6	
39.D20/20	SH 55	20	20	15	M5	
39.D20/20-M6x43	SH 43	20	20	15	M6	
39.D20/20-M6	SH 55	20	20	18	M6	
39.D25/15	SH 55	25	15	18	M6	
39.D25/15-A2	SH 68	25	15	18	M6	A2: Rustfri <i>Stainless</i>
39.D25/18	SH 55	25	18	20	M8	
39.D30/8-M6GX	SH 55	30	8	15	M6	Grå <i>Grey</i> - RAL 7035
39.D30/8-M6x18	SH 55	30	8	18	M6	
39.D30/8-M6x23	SH 55	30	8	23	M6	
39.D30/8-M6G	SH 55	30	8	28	M6	Grå <i>Grey</i> - RAL 7035
39.D30/10-M6x15	SH 55	30	10	15	M6	
39.D30/10-M6	SH 55	30	10	18	M6	
39.D30/10-M6x28	SH 55	30	10	28	M6	
39.D30/10	SH 55	30	10	20	M8	
39.D30/10-A2	SH 55	30	10	20	M8	A2: Rustfri <i>Stainless</i>
39.D30/12-M6G	SH 55	30	12	23	M6	Grå <i>Grey</i> - RAL 7035
39.D30/15-M6	SH 55	30	15	18	M6	
39.D30/15-M6G	SH 55	30	15	23	M6	Grå <i>Grey</i> - RAL 7035
39.D30/15	SH 55	30	15	20	M8	
39.D30/15-M8x23	SH 55	30	15	23	M8	
39.D30/15-M10x25	SH 55	30	15	25	M10	
39.D30/15-M10x50	SH 55	30	15	50	M10	
39.D30/18-M10	SH 55	30	18	18	M10	
39.D30/20-M6-43	SH 43	30	20	18	M6	
39.D30/20-M6	SH 55	30	20	20	M6	
39.D30/20-M8x15	SH 55	30	20	15	M8	
39.D30/20	SH 55	30	20	20	M8	
39.D30/30-M6	SH 55	30	30	18	M6	
39.D30/30	SH 55	30	30	20	M8	
39.D40/15-M6	SH 55	40	15	18	M6	
39.D40/15	SH 55	40	15	20	M8	
39.D40/20-M6-43	SH 43	40	20	18	M6	
39.D40/20-M6	SH 55	40	20	18	M6	
39.D40/20	SH 55	40	20	18	M8	
39.D40/20-M10	SH 55	40	20	20	M10	
39.D40/20-A2	SH 55	40	20	20	M10	A2: Rustfri <i>Stainless</i>
39.D40/25-A2-S	SH 60	40	25	30	M8	A2: Rustfri <i>Stainless</i> Silikone, FDA conform Blå <i>Blue</i> - RAL 5002
39.D40/25-A2	SH 55	40	25	20	M10	A2: Rustfri <i>Stainless</i>

TYPE D

Flere størrelser kan skaffes på bestilling

More sizes available on request

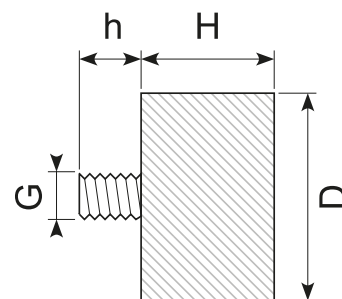

Varenr. <i>Item no.</i>	Hårdhed <i>Hardness</i>	D	H	h	G	Bemærk <i>Note</i>
39.D40/30-M8	SH 55	40	30	18	M8	
39.D40/30-M8x23	SH 55	40	30	23	M8	
39.D40/30-A2	SH 55	40	30	20	M10	A2: Rustfri <i>Stainless</i>
39.D40/30	SH 55	40	30	23	M10	
39.D40/35-M8-A2	SH 55	40	35	20	M8	A2: Rustfri <i>Stainless</i>
39.D40/35	SH 55	40	35	20	M10	
39.D40/35-A2	SH 55	40	35	20	M10	A2: Rustfri <i>Stainless</i>
39.D40/38	SH 55	40	38	25	M8	
39.D40/40-M8x23-68	SH 68	40	40	23	M8	
39.D40/40	SH 55	40	40	20	M10	
39.D40/40-A2	SH 55	40	40	20	M10	A2: Rustfri <i>Stainless</i>
39.D40/45-A2	SH 55	40	45	20	M10	
39.D50/20-M10x15	SH 70	50	20	15	M10	
39.D50/20	SH 70	50	20	28	M10	
39.D50/20-M12	SH 55	50	20	23	M12	
39.D50/25	SH 55	50	25	20	M10	
39.D50/30-M10	SH 55	50	30	20	M10	
39.D50/30-M10-A2	SH 55	50	30	28	M10	A2: Rustfri <i>Stainless</i>
39.D50/30-M10x38	SH 55	50	30	38	M10	
39.D50/30	SH 55	50	30	20	M12	
39.D50/40-43	SH 43	50	40	10	M10	
39.D50/40	SH 55	50	40	20	M10	
39.D50/40NBR	SH 55	50	40	20	M10	NBR
39.D50/50	SH 55	50	50	20	M10	
39.D50/60	SH 55	50	60	28	M10	
39.D50/80	SH 55	50	80	28	M10	
39.D60/30	SH 55	60	30	28	M10	
39.D60/30-M12	SH 55	60	30	23	M12	
39.D60/40	SH 55	60	40	28	M10	
39.D60/40M12	SH 55	60	40	23	M12	
39.D60/50	SH 55	60	50	28	M10	
39.D65/35	SH 55	65	35	20	M12	
39.D70/40	SH 55	70	40	28	M10	
39.D70/40-M12	SH 55	70	40	27	M12	
39.D70/45-M10x12	SH 55	70	45	12	M10	
39.D75/40-68	SH 68	75	40	30	M12	
39.D75/50-M10	SH 55	75	50	28	M10	
39.D75/50-M10/sh68	SH 68	75	50	28	M10	
39.D75/50-M12	SH 55	75	50	20	M12	
39.D100/30	SH 55	100	30	41	M16	
39.D100/50	SH 55	100	50	41	M16	
39.D100/75	SH 55	100	75	41	M16	
39.D150/50	SH 55	150	50	41	M16	

TYPE E

Flere størrelser kan skaffes på bestilling
More sizes available on request

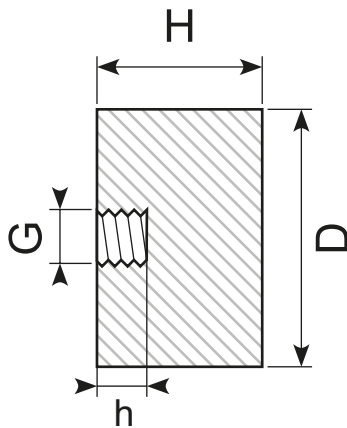
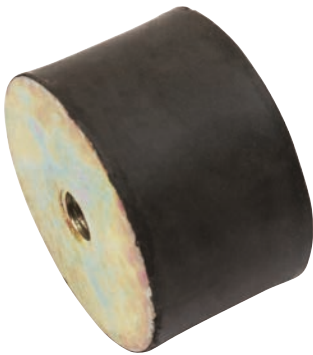

Varenr. <i>Item no.</i>	Hårdhed <i>Hardness</i>	D	H	h	G	Bemærk <i>Note</i>
39.E20/10-M6	SH 55	20	10	6	M6	
39.E20/10	SH 55	20	10	8	M8	
39.E20/25-68	SH 68	20	25	6	M6	
39.E25/10-M6	SH 55	25	10	6	M6	
39.E25/10	SH 55	25	10	8	M8	
39.E25/25	SH 57	25	25	6	M6	
39.E25/25-68	SH 68	25	25	6	M6	
39.E30/10-M6-43	SH 43	30	10	6	M6	
39.E30/10-M6G	SH 55	30	10	6	M6	Grå Grey - RAL 7035
39.E30/15-M6	SH 55	30	15	6	M6	
39.E30/15-M6G	SH 55	30	15	6	M6	Grå Grey - RAL 7035
39.E30/15	SH 55	30	15	8	M8	
39.30/17	SH 55	30	17	8	M8	
39.E30/20-M6	SH 55	30	20	6	M6	
39.E30/20	SH 55	30	20	8	M8	
39.E30/30-M6	SH 55	30	30	6	M6	
39.E30/30	SH 55	30	30	8	M8	
39.E30/35	SH 55	30	35	8	M8	
39.E40/15-SH.43	SH 43	40	15	8	M8	
39.E40/20-M6	SH 55	40	20	6	M6	
39.E40/20	SH 55	40	20	8	M8	
39.E40/20NBR	SH 57	40	20	8	M8	NBR
39.E40/30	SH 55	40	30	8	M8	
39.E50/20	SH 55	50	20	8	M8	
39.E50/20-M10	SH 55	50	20	10	M10	
39.E50/20-M12	SH 55	50	20	12	M12	
39.E50/25	SH 55	50	25	10	M10	
39.E50/25-M12	SH 55	50	25	12	M12	
39.E50/40	SH 55	50	40	10	M10	
39.E50/40-M12	SH 55	50	40	12	M12	
39.E60/30	SH 55	60	30	10	M10	
39.E60/30-M12	SH 55	60	30	12	M12	
39.E60/40	SH 55	60	40	10	M10	
39.E60/40-M12	SH 55	60	40	12	M12	
39.E70/35	SH 55	70	35	12	M12	
39.E70/50	SH 55	70	50	12	M12	
39.E75/30	SH 55	75	30	10	M10	
39.E75/30-M12	SH 55	75	30	12	M12	
39.E75/45-M12	SH 55	75	45	12	M12	
39.E75/50	SH 55	75	50	10	M10	
39.E75/50-M12	SH 55	75	50	12	M12	
39.E80/50	SH 55	80	50	12	M12	
39.E80/50-M16	SH 55	80	50	16	M16	
39.E100/25	SH 55	100	25	16	M16	
39.E100/30	SH 55	100	30	16	M16	
39.E100/40NBR43	SH 43	100	40	16	M16	
39.E100/40	SH 55	100	40	16	M16	
39.E100/40NBR	SH 55	100	40	16	M16	NBR
39.E100/40NBR68	SH 68	100	40	16	M16	NBR
39.E100/55NBR68	SH 68	100	55	16	M16	
39.E100/75	SH 55	100	75	16	M16	
39.E150/50	SH 55	150	50	16	M16	
39.E150/50-M20	SH 55	150	50	20	M20	
39.E150/75-M20	SH 55	150	75	20	M20	

Silicone, FDA

Rubber Buffer | Type M

Vare Nr.: 39.M100/55FDA

Diameter (D): Ø100 mm | Højde (H): 55 mm

Gevind (Gxh): M16x41 mm i begge ender

Materiale: Silicone, FDA

Hårdhed: sh.55A

Stål: A4

Rubber Buffer | Type M

Art. Nr.: 39.M100/55FDA

Diameter (D): Ø100 mm | Height (H): 55 mm

Threaded Stud (Gxh): M16x41mm in both ends

Material: Silicone, FDA

Hardness: sh.55A

Steel Parts: A4

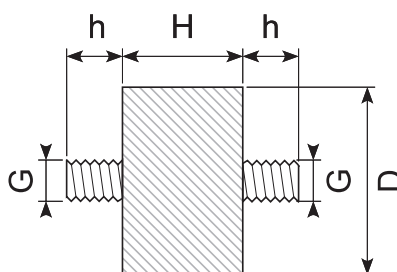
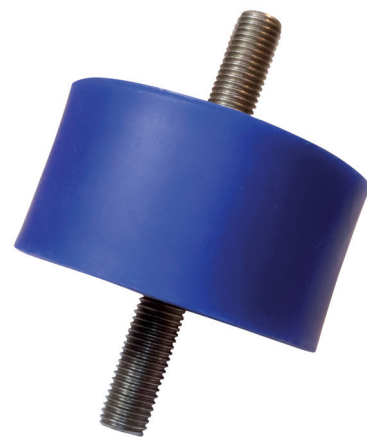

Type M

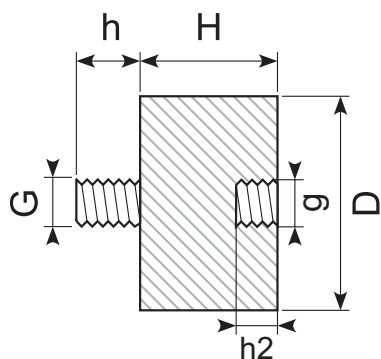

Type B

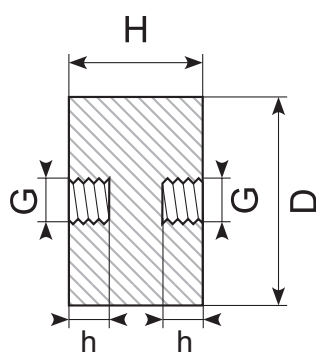

Type C

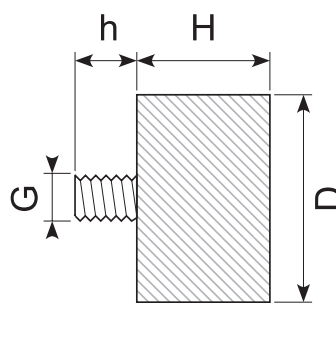

Type D

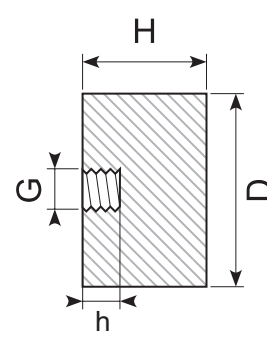

Type E

For yderligere hjælp eller forespørgsler, bedes du kontakte os via kontaktoplysningerne nedenfor.

For further assistance or inquiries, please reach out to us via the contact details listed below.

BIBUS SINDBY A/S

Edisonvej 11

DK-7100 Vejle

Phone: +45 75 88 21 22

bibus@bibus.dk

ordre@bibus.dk

www.bibus-sindby.dk

Model KP-E

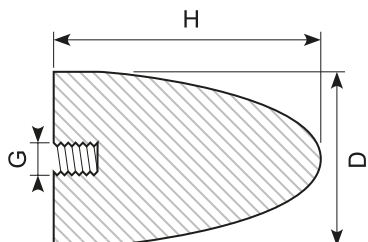

Model: KP-E Varenr. <i>Item no.</i>	D/H	D	H	G
39.KP-E10/10	10/10	10	10	M5
39.KP-E15/22 *	15/22	15	22	M6
39.KP-E20/15 *	20/15	20	15	M6
39.KP-E20/24	20/24	20	24	M6
39.KP-E25/16	25/16	25	16	M6
39.KP-E25/20 *	25/20	25	20	M6
39.KP-E30/30 *	30/30	30	30	M8
39.KP-E30/36	30/36	30	36	M8
39.KP-E35/40 *	35/40	35	40	M8
39.KP-E50/50 *	50/50	50	50	M10
39.KP-E50/61 *	50/61	50	61	M8
39.KP-E50/67 *	50/67	50	67	M8
39.KP-E50/68	50/68	50	68	M10
39.KP-E60/40	60/40	60	40	M10
39.KP-E70/58 *	70/58	70	58	M12
39.KP-E70/60 *	70/60	70	60	M12
39.KP-E75/89	75/89	75	89	M12
39.KP-E75/89-M10 *	75/89	75	89	M10
39.KP-E95/80 *	95/80	95	80	M16
39.KP-E115/136 *	115/136	115	136	M16
39.KP-E118/77 *	118/77	118	77	M16

Model KP-D

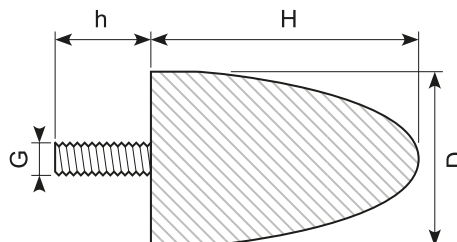

Model: KP-D Varenr. <i>Item no.</i>	D/H	D	H	G	h
39.KP-D10/10	10/10	10	10	M5	12
39.KP-D15/22	15/22	15	22	M6	18
39.KP-D20/15	20/15	20	15	M6	10
39.AV2024	20/24	20	24	M6	18
39.KP-D25/16	25/16	25	16	M6	18
39.KD25/17 *	25/17	25	17	M6	8
39.KP-D25/20	25/20	25	20	M6	18
39.KP-D30/30	30/30	30	30	M8	20
39.KP-D30/36 *	30/36	30	36	M8	20
39.KP-D30/36-A2 *	30/36	30	36	M12	37
39.KP-D30/36-A4 *	30/36	30	36	M12	37
39.AV30	30/40	30	40	M8	23
39.KD50/18 *	50/18	50	18	M10	18
39.KP-D50/50 *	50/50	50	50	M10	28
39.KP-D50/58	50/58	50	58	M10	28
39.KP-D50/61	50/61	50	61	M8	28
39.KP-D50/67	50/67	50	67	M8	33
39.AV5068	50/68	50	68	M10	38
39.KP-D60/40	60/40	60	40	M10	28
39.KP-D70/58 *	70/58	70	58	M12	32
39.KP-D70/60 *	70/60	70	60	M12	37
39.KP-D75/89	75/89	75	89	M12	37
39.KP-D75/89-10 *	75/89	75	89	M10	37
39.AV9580	95/80	95	80	M16	41
39.KP-D115/136 *	115/136	115	136	M16	41
39.KP-D118/77 *	118/77	118	77	M16	41

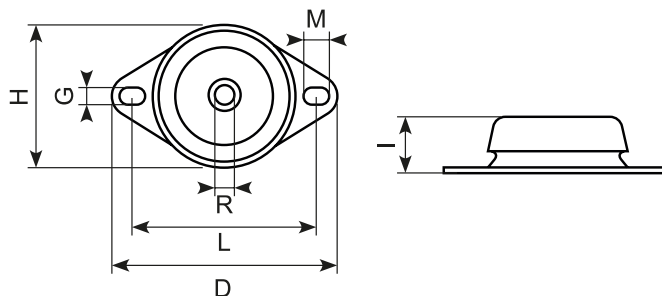

Varenr. <i>Item no.</i>	I	H	G	M	R	L	D	Belastning <i>Load</i>
39.GMF67/34-SH.40	34	67	11	12	M12	88	110	30-40 kg
39.GMF67/34	34	67	11	12	M12	88	110	60 kg
39.GMF75/34	34	75	12	16	M12	100	130	100 kg
39.GMF100/42	42	100	12	16	M12	120	153	200-300 kg
39.GMF108/46	46	108	14	18	M12	142	177	400-500 kg
39.GMF122/50	50	122	14	20	M16	158	192	600-800 kg
39.GMF150/54	54	150	14	18	M18	183	218	1000-1200 kg

* Skaffevare Special order item

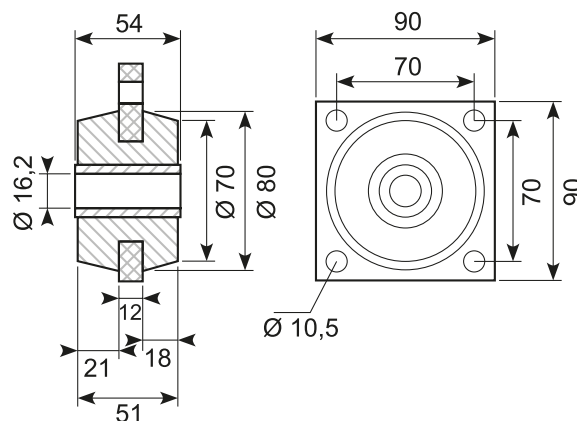
Gummiophæng *Rubber suspension***Material:** NR/SBR**Hardness:** SH 55

Showroom

Vi ved, hvor vigtigt det kan være at se og sammenligne produkterne, inden man køber dem. Derfor er vores showroom fyldt med et bredt udvalg af vores profiler. Du kan altid komme forbi på vores adresse **Edisonvej 11 i Vejle** for at tage et kig i vores showroom.

Vi glæder os til at hjælpe dig med alle slags opgaver.

*We know how important it can be to see and compare products before you buy them. That's why our showroom is filled with a wide range of our profiles. You can always visit us at our address **Edisonvej 11 in Vejle** to take a look in our showroom.*

We look forward to helping you with all kinds of tasks.



Fendere

Fenders

Fendere er stødabsorberende gummiemner som ofte bruges til både, trucks, lastbiler og på havne. Fendere kan findes overalt i transport og logistikverdenen. Findes i EPDM og NR/SBR, men kan også fås i andre materialer.

Fenders are shock-absorbing rubber items commonly used for boats, in harbors, forklifts and trucks. Fenders can be found everywhere in the transport and logistics world. Available in EPDM and NR / SBR. However, we can also order them in other materials.



Fendere til f.eks. havne og læsseramper

Fenders for e.g. harbours and loading ramps

Material: EPDM, sort *black*

Hardness: SH 70

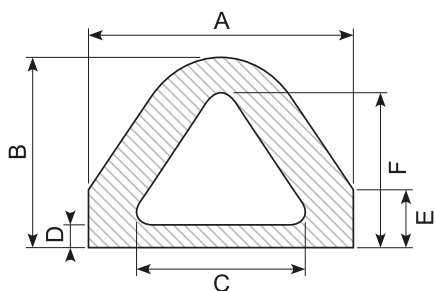

Varenr. <i>Item no.</i>	A	B	C	D	E	F	Kg/m
39.3872	40 mm	25 mm	28 mm	5 mm	10 mm	20 mm	0,6
39.3873 *	55 mm	40 mm	38 mm	8 mm	15 mm	32 mm	1,4
39.3875 *	60 mm	50 mm	40 mm	10 mm	20 mm	42 mm	1,8
39.4087 *	60 mm	52 mm	30 mm	11 mm	11 mm	43 mm	2
39.3876	80 mm	65 mm	50 mm	12 mm	25 mm	39 mm	3,2
39.3887 *	80 mm	70 mm	40 mm	15 mm	0 mm	68 mm	3,5
39.4333 *	80 mm	70 mm	54 mm	15 mm	16 mm	59 mm	4
39.2486 *	82 mm	67 mm	42 mm	15 mm	15 mm	57 mm	3,5
39.4156 *	109 mm	117 mm	50 mm	42 mm	50 mm	95 mm	10,5
39.3846 *	110 mm	95 mm	50 mm	22 mm	18 mm	76 mm	6,1
39.3874 *	110 mm	95 mm	70 mm	15 mm	30 mm	80 mm	5,8
39.4399 *	110 mm	130 mm	70 mm	20 mm	45 mm	110 mm	7,8
39.3010 *	120 mm	110 mm	70 mm	14 mm	35 mm	95 mm	7,4
39.3868 *	150 mm	130 mm	100 mm	20 mm	40 mm	110 mm	10,8
39.4178 *	150 mm	160 mm	105 mm	50 mm	60 mm	130 mm	16,3
39.3722 *	160 mm	138 mm	92 mm	33 mm	0 mm	105 mm	15,8
39.3240 *	170 mm	130 mm	110 mm	15 mm	45 mm	110 mm	10,5

Fendere til f.eks. varevogne, havne og læsseramper

Fenders for e.g. vans, harbours and loading ramps

Material: EPDM

Hardness: SH 70

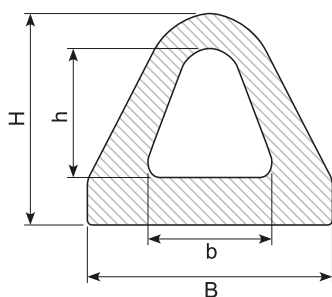

Varenr. <i>Item no.</i>	B	H	b	h	L	Kg/m	Farve <i>Colour</i>	Min. <i>order</i>
39.674	40 mm	22 mm			20 m	0,7	Sort <i>Black</i>	
39.678	60 mm	50 mm	27 mm	28 mm	10 m	2,1	Sort <i>Black</i>	
39.678X *	50 mm	60 mm			20 m	2,1	Sort <i>Black</i>	
39.680X	84 mm	70 mm	46 mm	41 mm	20 m	3,7	Sort <i>Black</i>	
39.684X	110 mm	95 mm			10 m	7	Sort <i>Black</i>	
39.684XS * Soft - SH 45							Sort <i>Black</i>	40 m
39.685 *	120 mm	120 mm			3 m	11,2	Sort <i>Black</i>	
39.680H *							Hvid <i>White</i>	100 m
39.680H-1180	84 mm	70 mm			1,18 m		Hvid <i>White</i>	

39.4380X

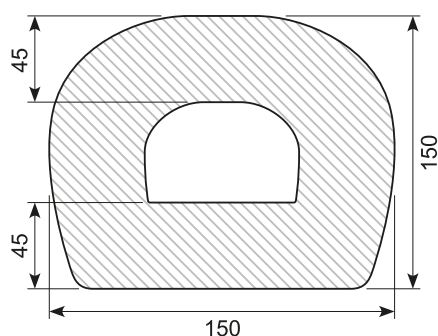

Material: NR / SBR
Length: 2 m

* Skaffevare *Special order item*

Fendere til f.eks. havne og læsseramper
Fenders for e.g. harbours and loading ramps
Material: EPDM, sort *black*
Hardness: SH 70

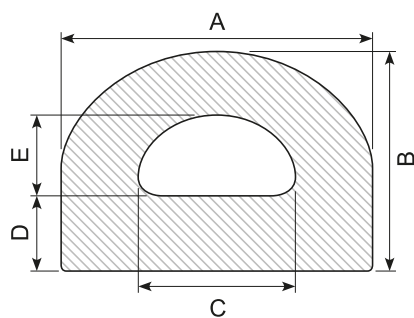

Varenr. <i>Item no.</i>	A	B	C	D	E	Kg/m
39.3581	30 mm	25 mm	11 mm	7,5 mm	11 mm	0,67
39.36412 *	40 mm	75 mm	23 mm	32 mm	23 mm	3,76
39.2776 *	51 mm	45 mm	20 mm	10 mm	20 mm	2,08
39.3428 *	65 mm	70 mm	35 mm	18 mm	28 mm	2,99
39.4229 *	80 mm	70 mm	46 mm	25 mm	20 mm	4,57
39.3700 *	80 mm	78 mm	56 mm	12 mm	54 mm	3,55
39.3029 *	80 mm	80 mm	40 mm	25 mm	35 mm	5,54
39.3925 *	80 mm	80 mm	40 mm	23 mm	40 mm	5,59
39.4110 *	95 mm	100 mm	38 mm	30 mm	45 mm	5,4
39.4251 *	100 mm	60 mm	50 mm	20 mm	20 mm	5,81
39.3051 *	100 mm	80 mm	50 mm	25 mm	30 mm	7,05
39.3802	100 mm	80 mm	80 mm	12 mm	56 mm	3,68
39.3923 *	100 mm	95 mm	44 mm	29 mm	40 mm	8,1
39.3952 *	100 mm	95 mm	60 mm	20 mm	50 mm	6,99
39.4403 *	100 mm	95 mm	60 mm	28 mm	42 mm	6,27
39.4310 *	107 mm	67 mm	40 mm	22 mm	20 mm	6,4
39.3726 *	110 mm	110 mm	50 mm	30 mm	25 mm	12,14
39.3878 *	120 mm	70 mm	30 mm	20 mm	30 mm	6,41
39.93 *	120 mm	120 mm	70 mm	44 mm	51 mm	11,84
39.4381 *	125 mm	100 mm	65 mm	33 mm	37 mm	10,87
39.4257 *	130 mm	145 mm	40 mm	55 mm	40 mm	17,24
39.69 *	130 mm	150 mm	50 mm	50 mm	50 mm	21,05
39.3815 *	140 mm	80 mm	60 mm	20 mm	36 mm	10,27
39.3813 *	140 mm	125 mm	85 mm	35 mm	55 mm	14,75
39.4129 *	150 mm	130 mm	50 mm	55 mm	50 mm	20
39.4380 *	150 mm	150 mm	80 mm	40 mm	75 mm	18,22
39.3381 *	150 mm	150 mm	85 mm	30 mm	85 mm	18,81
39.4224 *	150 mm	150 mm	92 mm	29 mm	92 mm	14,7
39.4244 *	150 mm	180 mm	45 mm	87 mm	40 mm	27,8
39.3366 *	160 mm	125 mm	90 mm	25 mm	65 mm	15,82
39.4311 *	160 mm	175 mm	68 mm	79 mm	68 mm	17,1
39.3023 *	190 mm	195 mm	21 mm	89 mm	21 mm	40,57
39.4012 *	190 mm	195 mm	55 mm	89 mm	55 mm	37,7
39.3803 *	200 mm	150 mm	148 mm	14 mm	113 mm	11,81
39.57 *	200 mm	165 mm	40,5 mm	80 mm	40,5 mm	31,44
39.4269 *	200 mm	220 mm	75 mm	82 mm	75 mm	36,85
39.4249 *	200 mm	220 mm	75 mm	82 mm	75 mm	42,39
39.4250 *	200 mm	220 mm	100 mm	38 mm	80 mm	39,38
39.3849 *	240 mm	260 mm	110 mm	90 mm	110 mm	54,54
39.56 *	250 mm	200 mm	136 mm	50 mm	100 mm	39,84
39.3879 *	250 mm	290 mm	120 mm	60 mm	110 mm	48,96
39.4054 *	280 mm	190 mm	180 mm	50 mm	90 mm	38,5
39.79 *	300 mm	254 mm	150 mm	75 mm	104 mm	68,25
39.55 *	350 mm	350 mm	220 mm	80 mm	165 mm	97,68

DD-fender

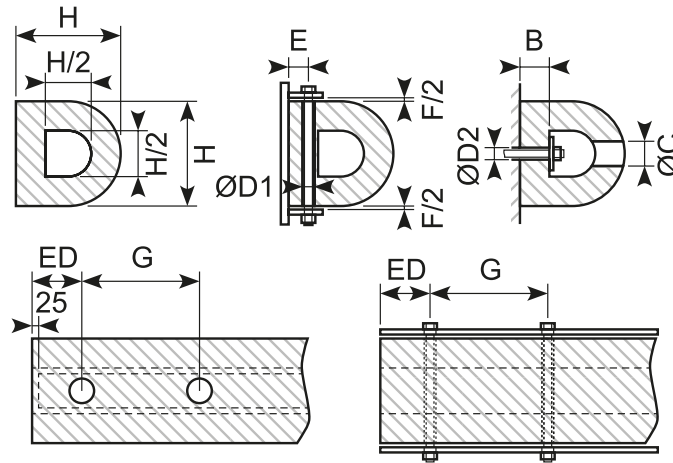

Varenr. <i>Item no.</i>	H mm	B mm	C mm	D1 mm	D2 mm	E mm	F mm	G mm	ED mm	Flad bar <i>Flat bar</i> mm	Ankre <i>Anchors</i>	Vægt <i>Weight</i> kg/m
* 100 x 100	100	25	30	18	24	25	10	200-300	90-130	40 x 5	M12	8,3
39.DD150150 *	150	37,5	40	24	32	30	12	250-350	110-150	50 x 8	M16	18
* 200 x 200	200	50	50	30	40	45	15	300-400	130-180	70 x 8	M20	32
* 250 x 250	250	62,5	60	36	48	50	20	350-450	140-200	90 x 12	M24	50
39.DD300300 *	300	75	60	36	48	60	25	350-450	140-200	100 x 12	M24	72
39.DD350350 *	350	87,5	75	45	60	70	25	350-450	140-200	130 x 15	M30	103,6
* 380 x 380	380	95	75	45	60	80	30	350-450	140-200	140 x 15	M30	122,1
* 400 x 400	400	100	75	45	60	80	30	350-450	140-200	150 x 15	M30	128
* 500 x 500	500	125	90	54	72	90	40	400-500	160-230	180 x 20	M36	200

SD-fender

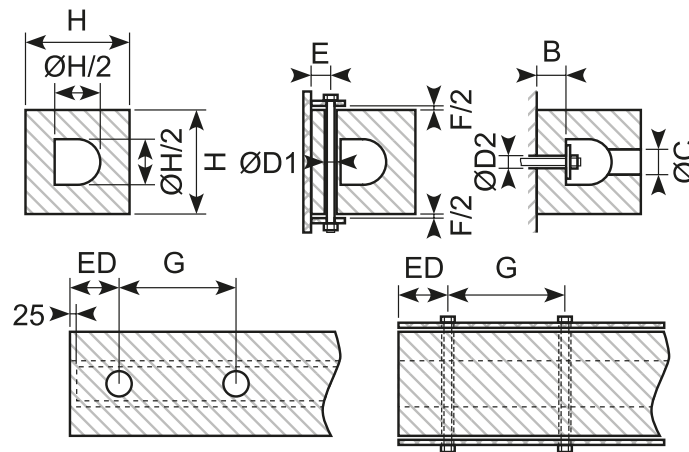

Varenr. <i>Item no.</i>	H mm	B mm	C mm	D1 mm	D2 mm	E mm	F mm	G mm	ED mm	Flad bar <i>Flat bar</i> mm	Ankre <i>Anchors</i>	Vægt <i>Weight</i> kg/m
* 100 x 100	100	25	30	18	24	25	10	200-300	90-130	40 x 5	M12	9,5
* 150 x 150	150	37,5	40	24	32	30	12	250-350	110-150	50 x 8	M16	22,1
* 200 x 200	200	50	50	30	40	45	15	300-400	130-180	70 x 10	M20	38,7
39.SD300250 *	300	62,5	60	36	48	50	20	350-450	140-200	90 x 12	M24	59,3
39.SD300300 *	300	75	60	36	48	60	25	350-450	140-200	100 x 12	M24	85
* 350 x 350	350	87,5	75	45	60	70	25	350-450	140-200	130 x 15	M30	116
* 400 x 400	400	100	75	45	60	80	30	350-450	140-200	150 x 15	M30	148,5
* 500 x 500	500	125	90	54	72	90	40	400-500	160-230	180 x 20	M36	232,1

* Skaffevare *Special order item*

DC-fender

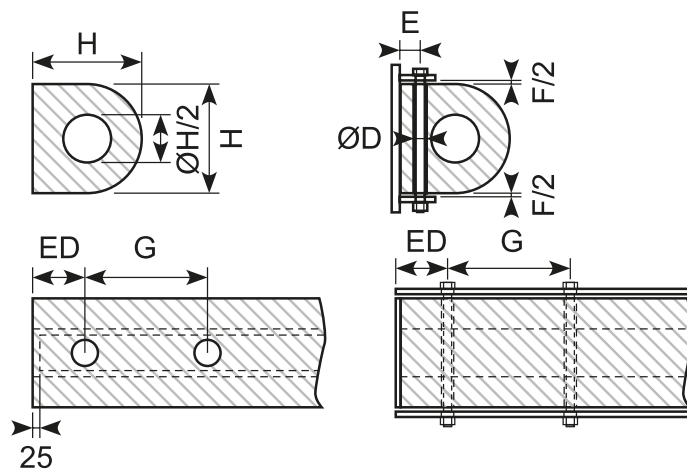

Varenr. <i>Item no.</i>	H mm	D2 mm	E mm	F mm	G mm	ED mm	Ankre <i>Anchors</i>	Vægt <i>Weight</i> kg/m
*	100 x 100	18	25	10	200-300	90-130	M12	9,9
*	150 x 150	24	30	12	250-350	110-150	M16	20
*	200 x 200	30	45	15	300-400	130-180	M20	37,4
*	250 x 250	36	50	20	350-450	140-200	M24	57,2
39.DC300300 *	300 x 300	36	60	25	350-450	140-200	M24	81,3
*	350 x 350	45	70	25	350-450	140-200	M30	109,5
*	400 x 400	45	80	30	350-450	140-200	M30	142
*	500 x 500	54	90	40	400-500	150-230	M36	208

SC-fender

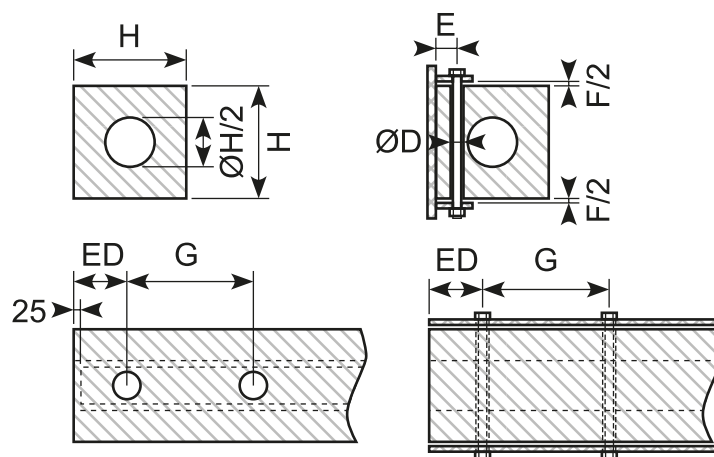

Varenr. <i>Item no.</i>	H mm	D2 mm	E mm	F mm	G mm	ED mm	Ankre <i>Anchors</i>	Vægt <i>Weight</i> kg/m
*	100 x 100	18	25	10	200-300	90-130	M12	11,1
*	150 x 150	24	30	12	250-350	110-150	M16	22,9
*	200 x 200	30	45	15	300-400	130-180	M20	42,6
*	250 x 250	36	50	20	350-450	140-200	M24	65,3
39.SC300300 *	300 x 300	36	60	25	350-450	140-200	M24	92,9
*	350 x 350	45	70	25	350-450	140-200	M30	117,6
*	400 x 400	45	80	30	350-450	140-200	M30	153,6
*	500 x 500	54	90	40	400-500	150-230	M36	240,1

39.BUMPER-CAR

Hjulstop/fender uden huller og montageplade til personbiler eller varevogne.
Wheel stop / fender without holes and mounting plate for cars or vans.
 150 x 130 x 1.200 mm

Keyhole fender

*

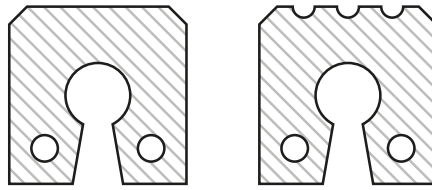
**Wing-type-fender**

*

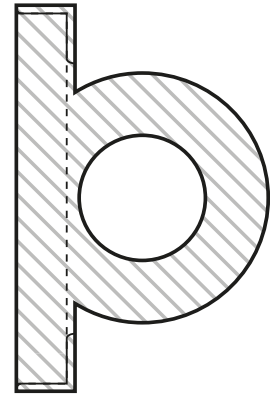
**MC-fender**

*

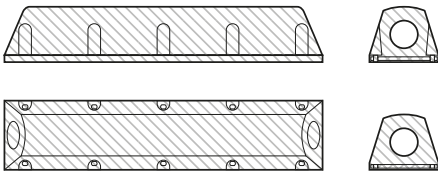
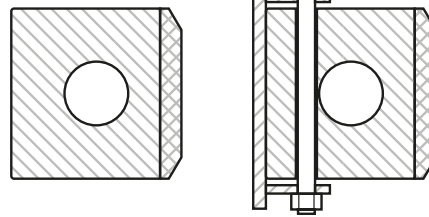
**KF-A-fender**

Composite front

KF-B-fender

*

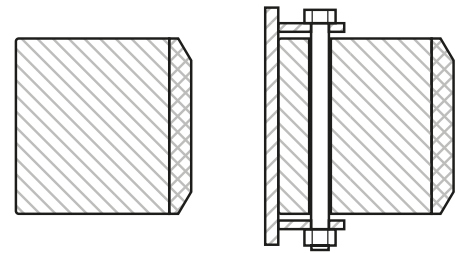

Composite front

KF-C-fender

*

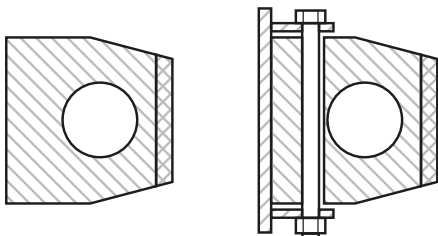

Composite front

KF-D-fender

*

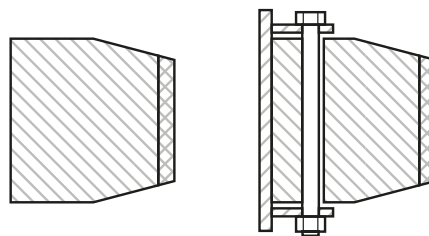

Composite front

Børste- og flocklister

Brush sections

Børstelister findes i forbindelse med porte og døre i industrien, hvor det gælder om at holde skidt, snavs og træk både ude og/eller inde.

Børsterne er som regel lavet af nylon, men kan også leveres med PP, hestehår eller rustfri tråd.

Børsterne og skinnerne kan købes separat.

Børstelisterne leveres i længder á 3 meter.

Brush sections are found in connection with gates and doors in industry, where it is important to keep dirt and drafts in and/or out.

The brushes are usually made of nylon, but can be delivered with PP, horse hairs or stainless steel wire.

Brushes and rails can be purchased separately.

Brush sections are supplied in length of 3 meters.

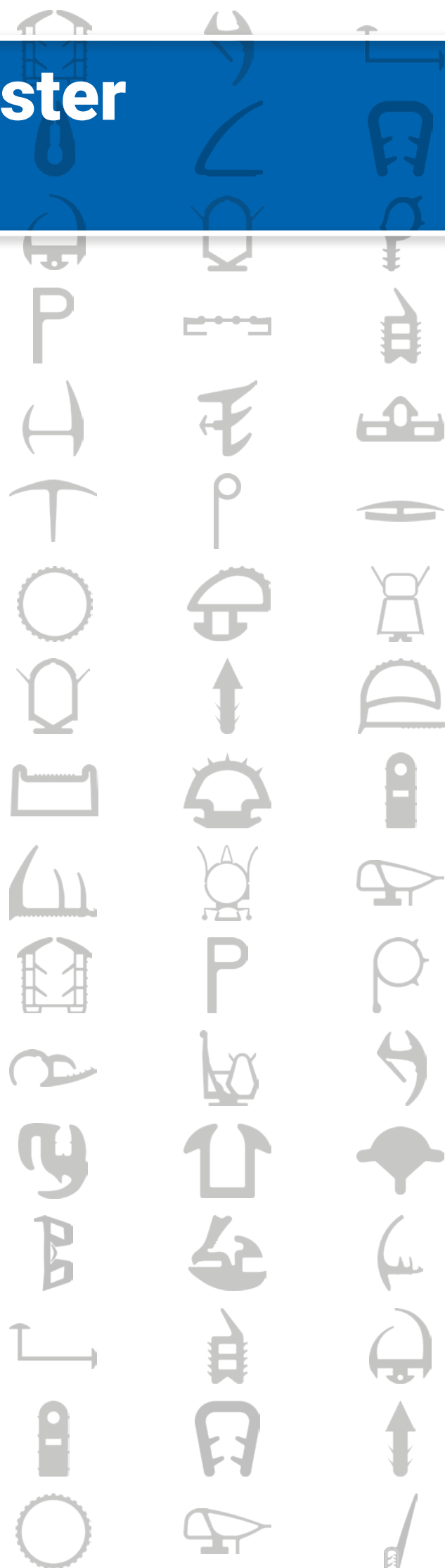

Varenr. <i>Item no.</i>	Type Tegning <i>Drawing</i>	B Børstelængde <i>Brush length</i>	T Totalhøjde <i>Total height</i>
57.400/3E *	A	10 mm	26 mm
57.401/3E	A	14 mm	30 mm
57.402/3E *	A	24 mm	40 mm
57.408/3E *	A	34 mm	50 mm
57.403/3E	B	25 mm	50 mm
57.410/3E	B	35 mm	60 mm
57.405/3E *	B	45 mm	70 mm
57.404/3E *	C	40 mm	90 mm
57.406/3E	C	60 mm	110 mm
57.411/3E	C	80 mm	130 mm
57.407/3E	C	100 mm	150 mm
57.412/3E *	C	120 mm	170 mm
57.413/3E *	C	150 mm	200 mm

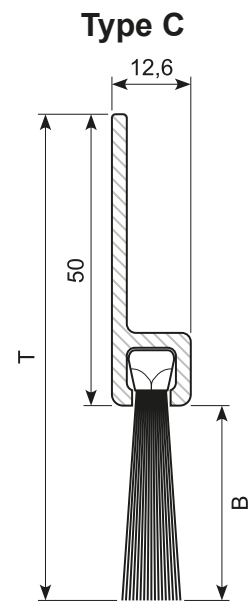
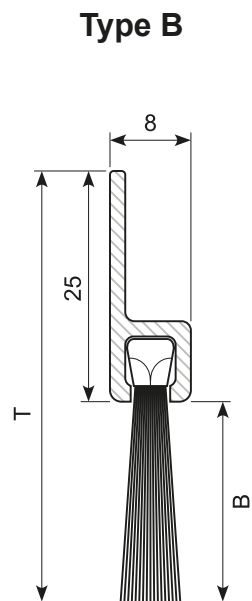
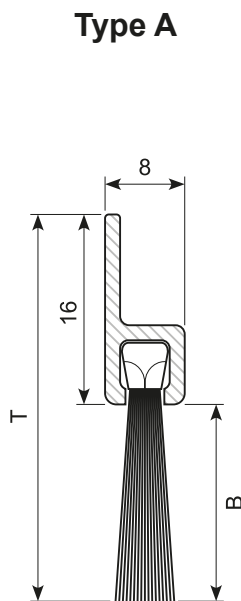

Varenr. <i>Item no.</i>	Type Tegning <i>Drawing</i>	B Børstelængde <i>Brush length</i>	T Totalhøjde <i>Total height</i>
57.440/3E *	D	10 mm	17 mm
57.441/3E *	D	14 mm	21 mm
57.442/3E *	D	24 mm	31 mm
57.445/3E *	D	34 mm	41 mm
57.443/3E *	E	25 mm	34 mm
57.449/3E *	E	35 mm	44 mm
57.444/3E *	E	45 mm	54 mm
57.450/3E *	F	40 mm	53 mm
57.446/3E *	F	60 mm	73 mm
57.448/3E *	F	80 mm	93 mm
57.447/3E *	F	100 mm	113 mm
57.451/3E *	F	120 mm	133 mm
57.452/3E *	F	150 mm	163 mm

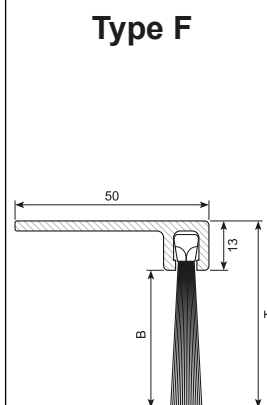
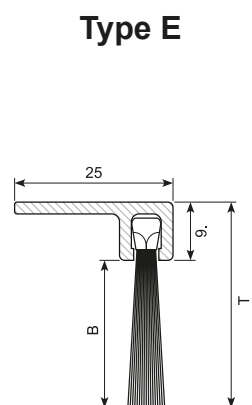
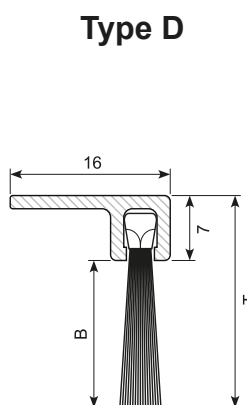

Varenr. <i>Item no.</i>	Type Tegning <i>Drawing</i>	B Børstelængde <i>Brush length</i>	T Totalhøjde <i>Total height</i>
57.453/3E *	G	10 mm	26 mm
57.454/3E *	G	14 mm	30 mm
57.455/3E *	G	24 mm	40 mm
57.456/3E *	G	34 mm	50 mm
57.423/3E *	H	25 mm	50 mm
57.424/3E *	H	35 mm	60 mm
57.425/3E *	H	45 mm	70 mm
57.426/3E *	I	40 mm	87 mm
57.427/3E *	I	60 mm	107 mm
57.428/3E *	I	80 mm	127 mm
57.429/3E	I	100 mm	147 mm
57.430/3E *	I	120 mm	167 mm
57.431/3E *	I	150 mm	197 mm

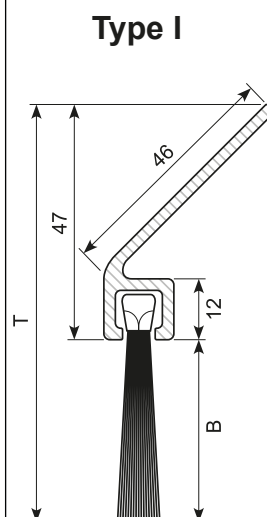
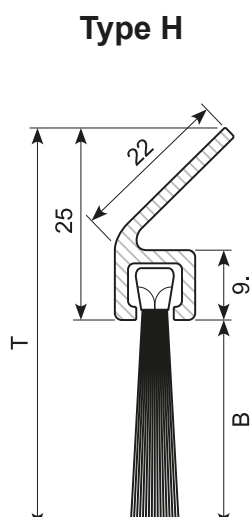
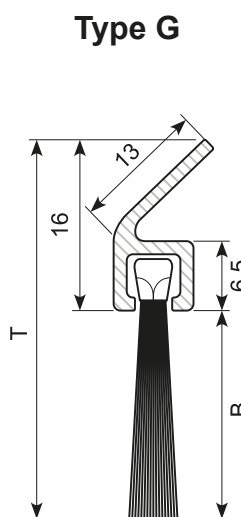

* Skaffevare *Special order item*

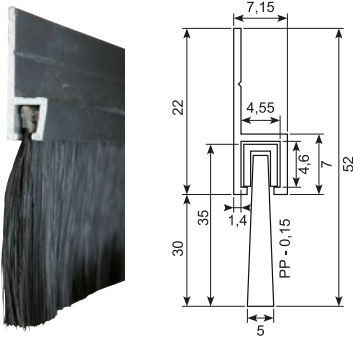
57.403/2.5J

Material: Aluminium med polypropylene børste
Aluminium with polypropylene brush
Length: 2,5 m

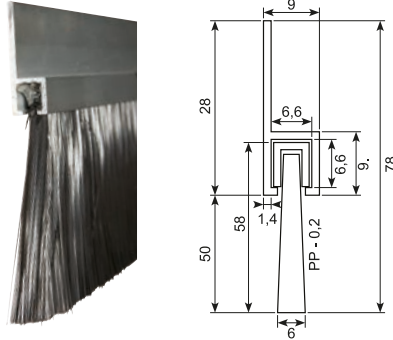
57.405/2J

Material: Aluminium med polypropylene børste
Aluminium with polypropylene brush
Length: 2 m

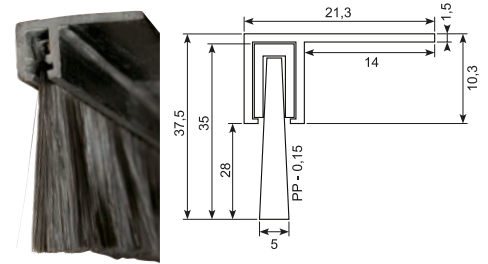
57.443/2JP

Material: Plastik med polypropylene børste
Plastic with polypropylene brush
Length: 2 m

57.401/3EJ

H-børsteliste. H: 30mm , BH: 14 mm.
Leveres i længder af 3 m
H-brush. H: 30 mm, BH: 14 mm.
Available in lengths of 3 m

57.402/3EJ

H-børsteliste. H: 40 mm, BH: 24 mm.
Leveres i længder af 3 m
H-brush. H: 40 mm, BH: 24 mm.
Available in lengths of 3 m

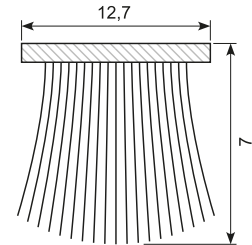
33.615

Selvklæbende liste med børster
Self-adhesive list with brushes

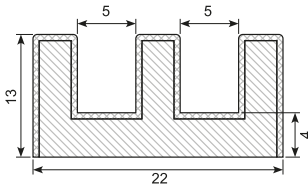
33.670

Kanalliste, dobbeltgummi med filt
Flocked channel molding
Material: EPDM, black
Hardness: SH 70

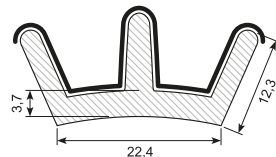
33.671

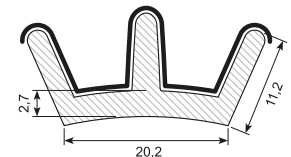

Material: EPDM
Density: 1,28
Hardness: SH 70
Flock: 3,3 dtex
Min. order: 2.000 m

33.672

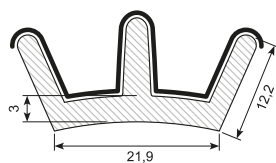
Material: EPDM
Density: 1,28
Hardness: SH 70
Flock: 3,3 dtex
Min. order: 2.000 m

33.673

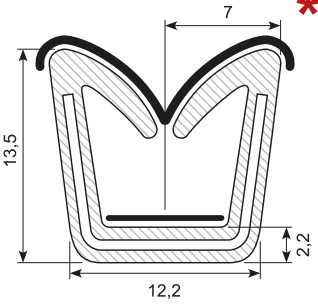
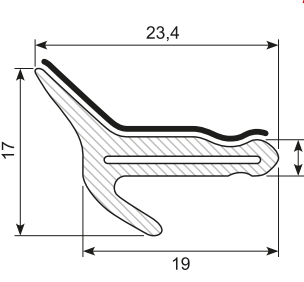
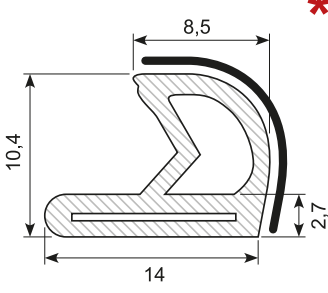
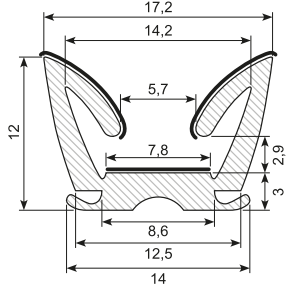
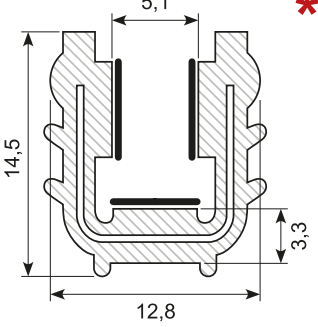
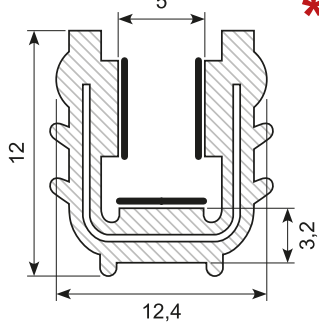
Material: EPDM
Density: 1,28
Hardness: SH 70
Flock: 3,3 dtex
Min. order: 2.000 m

<p style="text-align: center;">33.674 *</p>  <p>Material: EPDM Density: 1,28 Hardness: SH 70 Flock: 3,3 dtex Min. order: 3.000 m</p>	<p style="text-align: center;">33.675 *</p>  <p>Material: EPDM Density: 1,28 Hardness: SH 70 Flock: 3,3 dtex Min. order: 3.000 m</p>	<p style="text-align: center;">33.676 *</p>  <p>Material: EPDM Density: 1,28 Hardness: SH 70 Flock: 3,3 dtex Min. order: 3.000 m</p>	<p style="text-align: center;">30.13066</p>  <p>Material: EPDM Density: 1,28 Hardness: SH 70 Flock: 3,3 dtex Glass width: 5 mm <i>Discontinued when sold.</i> Alternative e.g. 30.13066NEW</p>
<p style="text-align: center;">33.624 *</p>  <p>Material: EPDM Density: 1,28 Hardness: SH 70 Flock: 3,3 dtex Min. order: 3.000 m</p>	<p style="text-align: center;">33.625 *</p>  <p>Material: EPDM Density: 1,28 Hardness: SH 70 Flock: 3,3 dtex Min. order: 3.000 m</p>		<p style="text-align: center;">33.416</p>  <p>Material: PVC, with brush Grip range: 1 - 2,5 mm Hardness: SH 78 Insert: 25 x 0,48 mm steel</p>

Lydisolering

Sound proofing

Lyddæmpende og lydisolerende plader sættes op for at dæmpe uønsket lyd og adskille støjilden fra det omliggende område. De anvendes ofte i motorrum, førerkabiner, kompressorer og meget mere.

Vi har dem i mange forskellige materialer, så du altid kan finde noget lyddæmpning, der dækker dine behov.

Sound absorbing panels are set up to muffle unwanted sound and to separate source of noise from the environment. Often used in engine rooms, cabins and compressors and far more places.

We offer sound proofing in many different materials, so you can always find something that suits your requirements.

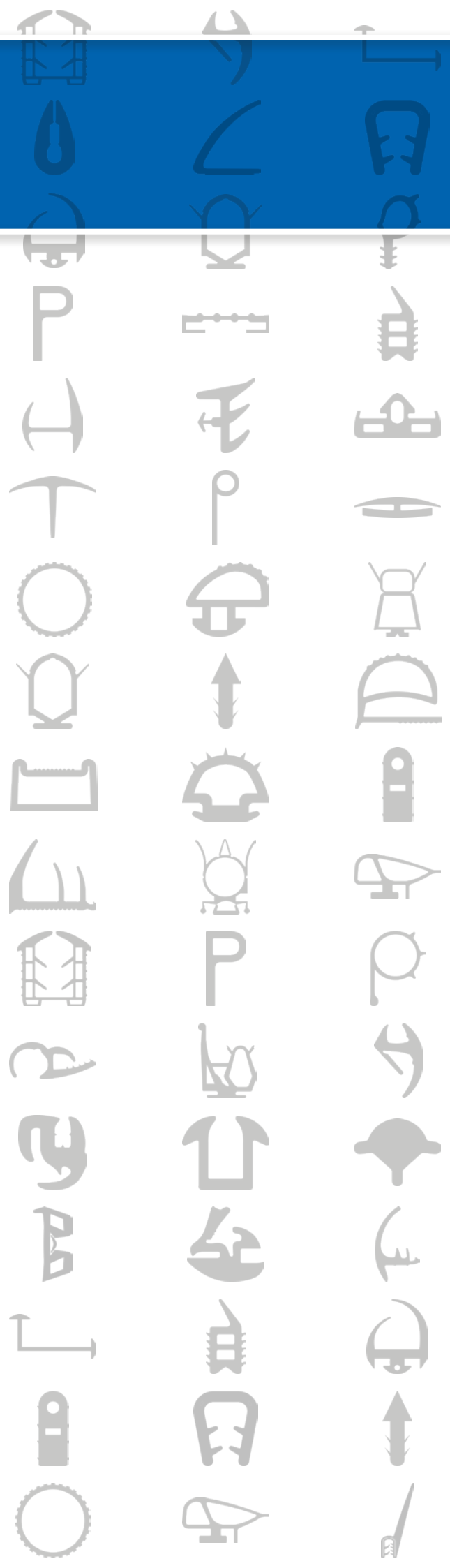

Selvklebende skum med Tedlarbelægning

Benyttes, alt afhængig af folieafdækning, i førerkabiner, motorrum, kompressorer, generatorer, ventilatorer, turbiner, pumper og lignende.

Self-adhesive foam with Tedlar coat

Depending on the foil covers this is used in cabs, engine compartment, compressors, generators, fans, turbines, pumps or the like.

Varenr. Item no.	Farve Color	Overflade Surface	Størrelse Size
48.603	Hvid White	Plan 100% Plane 100%	20 x 1.200 x 1.500 mm



Selvklebende skum med Bitumenindlæg

Self-adhesive foam with Bitumen inserts

Varenr. Item no.	Overflade Surface	Størrelse Size
48.613K	Folie, Plan 100% Foil, Plane 100%	33 x 600 x 1.000 mm

Selvklebende skum med gummioverflade

Self-adhesive foam with rubber surface

Varenr. Item no.	Farve Color	Overflade Surface	Størrelse Size
48.626	Sort Black	Plan 100% Plane 100%	2 / 10 x 1.200 x 1.500 mm

Lydisoleringsmaterialet er lavet af åbencellede, fleksible skummaterialer i tungere densiteter. Den forøgede densitet er opnået ved at anvende regenereret skum. Anvendelsesområdet kan være lydisolering af motorrum i lystbåde, vindmøllehuse, kompressorer og andre støjende maskiner, hvor det er muligt at adskille støjkilden fra det omliggende område. Da der ofte skal etableres et kølende luftskifte i disse situationer, laver man en lydsluse beklædt med lydabsorptionsmateriale. Granulatcoldskum med enestående lyddæmpningsevne benyttes til beklædning af motorrum, maskinafskærmninger, ventilationskamre og støjcabiner. Grundet den lave densitet kan den også med fordel anvendes som absorbent.

The soundproofing material is made of open-celled, flexible foam materials in heavier densities. The increased density is achieved by using regenerated foam. The field of application can be soundproofing of the engine compartment in yachting, wind turbine housings, compressors and other noisy machines where it is possible to separate the noise source from the surrounding area. It is often necessary to assure a cooling air circulation in these situations. Therefore it is recommended to make a sound lock covered with soundproofing material. Granulate cold foam with unique soundproofing ability is used for coating of engine compartment, machine guards, ventilation chambers and noise cabins. Due to the low density it may also be used as absorbent.

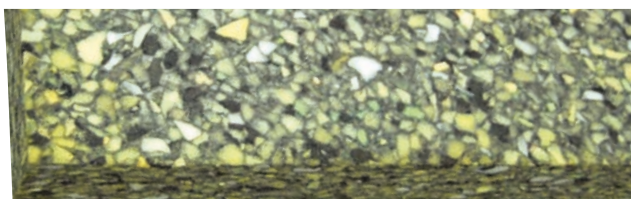

Varenr. Item no.	Overflade Surface	Størrelse Size
48.634	Ingen <i>None</i>	20 x 500 x 1.000 mm
48.635	Ingen <i>None</i>	30 x 500 x 1.000 mm
48.636	Ingen <i>None</i>	40 x 500 x 1.000 mm

Varenr. Item no.	Overflade Surface	Størrelse Size
48.634K	Klæb <i>Glue</i>	20 x 500 x 1.000 mm
48.635K	Klæb <i>Glue</i>	30 x 500 x 1.000 mm
48.636K	Klæb <i>Glue</i>	40 x 500 x 1.000 mm



Varenr. Item no.	Overflade Surface	Størrelse Size
48.634F	Folie <i>Foil</i>	20 x 500 x 1.000 mm
48.635F	Folie <i>Foil</i>	30 x 500 x 1.000 mm
48.636F	Folie <i>Foil</i>	40 x 500 x 1.000 mm
48.636FX	Folie <i>Foil</i>	40 x 1.000 x 2.000 mm

Varenr. Item no.	Overflade Surface	Størrelse Size
48.634KF	Folie og klæb <i>Foil and glue</i>	20 x 500 x 1.000 mm
48.635KF	Folie og klæb <i>Foil and glue</i>	30 x 500 x 1.000 mm
48.636KF	Folie og klæb <i>Foil and glue</i>	40 x 500 x 1.000 mm

Lydabsorptionsmaterialer (PU) er typisk lavet af åbencellede, fleksible skummaterialer i lettere densiteter. Anvendelsesområdet vil typisk være indvendig beklædning af førerkabiner, støjskærme, lydsluger, kanalvægge og lignende situationer, hvor det ikke er muligt at adskille støjekilden fra det omkringliggende område.

Soundproofing materials (PU) are typically made of open-celled, flexible foam materials in lighter densities. The field of application will typically be interior sheathing of cabs, noise barriers, sound locks, canal walls and similar situations where it is not possible to separate the noise source from the surrounding area.

Selvklæbende skum uden folie

Anvendes til indvendig beklædning af motorrum, maskinafskærmninger, støjkabiner, el-styretavler, paneler, indlæg i emballage m.m.

Self-adhesive foam without foil

This is used for interior sheathing of engine compartment, machine guards, noise cabins, electrical control panels and inserts in packaging with more.

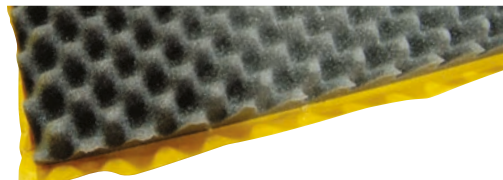
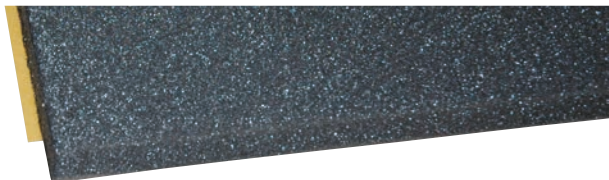

Varenr. Item no.	Overflade Surface	Størrelse Size
48.621	Plan <i>Plane</i>	10 x 1.200 x 1.500 mm
48.622	Plan <i>Plane</i>	20 x 1.200 x 1.500 mm
48.622X	Plan <i>Plane</i>	30 x 1.200 x 1.500 mm

Varenr. Item no.	Overflade Surface	Størrelse Size
48.623	Æggebakke <i>Egg tray</i>	30 / 15 x 1200 x 1500 mm
48.623X	Æggebakke <i>Egg tray</i>	30 / 15 x 1.200 x 2.000 mm
48.624	Æggebakke <i>Egg tray</i>	40 / 20 x 1200 x 1500 mm

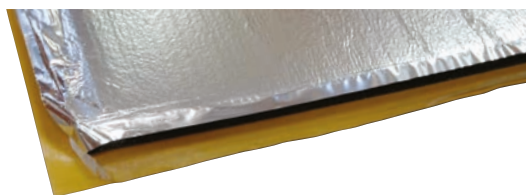

Varenr. Item no.	Farve Color	Overflade Surface	Størrelse Size
48.608	Alu.	Plan <i>Plane</i> 100%	20 x 1.200 x 1.500 mm
48.609	Alu.	Plan <i>Plane</i> 100%	30 x 1.200 x 1.500 mm

Selvklæbende skum med PVC-folie

Benyttes, alt afhængig af folieafdækning, til beklædning i førerkabiner, motorrum, kompressorer, generatorer, ventilatorer, turbiner, pumper og lignende.

Self-adhesive foam with PVC foil

Depending on the foil covers this is used for sheathing in cabs, engine compartment, compressors, generators, fans, turbines, pumps or the like.

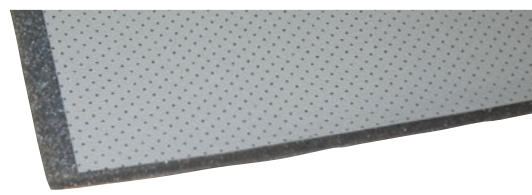
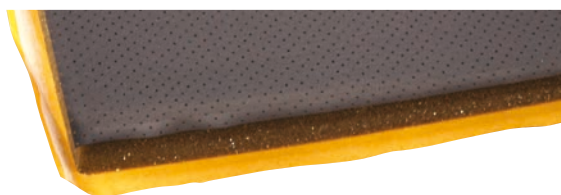

Varenr. Item no.	Farve Color	Overflade Surface	Størrelse Size
48.605X	Sort <i>Black</i>	2% perforated	10 x 1.200 x 1.500 mm
48.605	Sort <i>Black</i>	2% perforated	20 x 1.200 x 1.500 mm
48.605Y	Sort <i>Black</i>	2% perforated	30 x 1.200 x 1.500 mm

Varenr. Item no.	Farve Color	Overflade Surface	Størrelse Size
48.451	Grå <i>Grey</i>	2 % perf. / pap <i>2 % perf. / cardboard</i>	10 x 1.000 x 1.500 mm
48.452	Grå <i>Grey</i>	2 % perf. / pap <i>2 % perf. / cardboard</i>	20 x 1.000 x 1.500 mm



Varenr. Item no.	Farve Color	Overflade Surface	Størrelse Size
48.605B *	Brun <i>Brown</i>	2 % perforated	20 x 1.200 x 1.500 mm

Min. order: 10 pcs.

* Skaffevare *Special order item*

Bitumenplader

Baserer på kunststofmateriale. Lyddæmpningsmaterialet er lavet af hårdt og tungt materiale. Anvendelsesmulighederne kan være dæmpning af store pladearealer, bundplader i biler/maskiner, dørsider og andre steder, hvor der kan opstå resonans.

Bitumen plates

Based on synthetic material. The soundproofing material is made of hard and heavy material. The field of application can be damping of large plate areas, bottom plates in cars / machinery, doors and other places where there may be resonance.

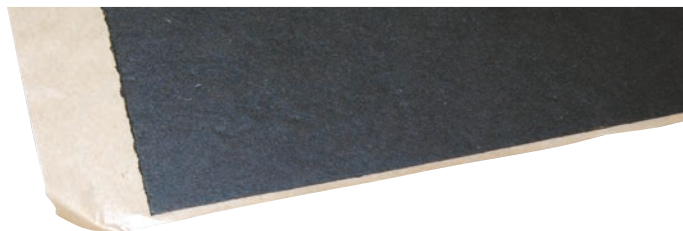
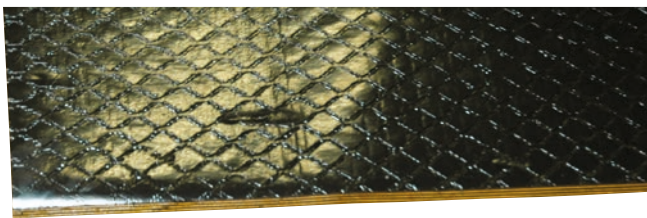

Varenr. <i>Item no.</i>	Overflade <i>Surface</i>	Pakke <i>Pack</i>	Størrelse <i>Size</i>
48.544A	Klæb <i>Adhesive</i>	4 pcs.	500 x 500 x 3 mm
48.542	Klæb <i>Adhesive</i>	6 pcs.	500 x 250 x 2,2 mm

Varenr. <i>Item no.</i>	Overflade <i>Surface</i>	Pakke <i>Pack</i>	Tykkelse <i>Thickness</i>	Størrelse <i>Size</i>
48.442	Klæb <i>Adhesive</i>	1 pc	1,7 mm	500 x 1.050 mm

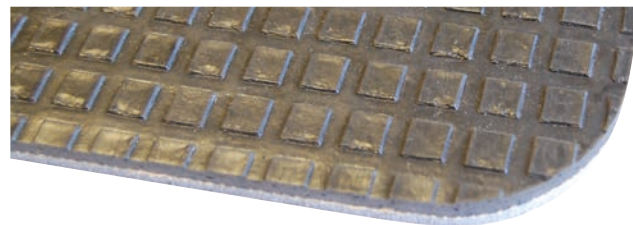
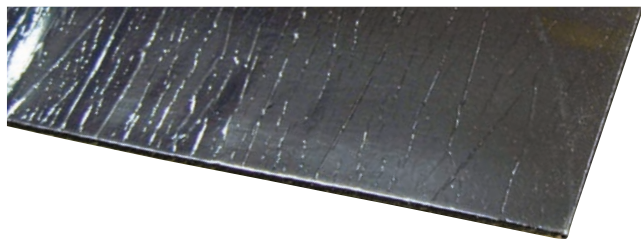

Varenr. <i>Item no.</i>	Overflade <i>Surface</i>	Pakke <i>Pack</i>	Tykkelse <i>Thickness</i>	Størrelse <i>Size</i>
48.612	Klæb <i>Adhesive</i>	1 pc	3 mm	750 x 1.200 mm

Varenr. <i>Item no.</i>	Tykkelse <i>Thickness</i>	Størrelse <i>Size</i>
48.618	10 mm	1.250 x 1.500 mm

68.4250



Alutape til samling af motorisolering. 50 mm x 10 m.
Alu tape for the assembly of motor insulation.
50 mm x 10 m.

63.550301



Plastskive Ø50 mm til montering af motorisolering.
Pakke med 40 stk.
Plastic disc with 50 mm diameter for mounting of motor insulation. Pack of 40 pcs.

Gummiplader fra Kina

Rubber sheets from China

Gummiplader produceret i Kina er prisgunstige alternativer til gummiplader produceret i Europa. De er ikke en erstatning for den europæiske kvalitet. Pladerne er et godt alternativ til mange af de gængse opgaver. De kan bruges til blandt andet: køretøjer, dyretransport, værkstedsgulve og meget mere.

Anbefales ikke til høj kvalitet pakninger med store krav til tolerancer og mekanisk styrke. Sammenlign evt. de tekniske beskrivelser. Pladerne har større tykkelsestolerancer end de europæiske.

Hele ruller leveres i plastfolie. Mange andre kvaliteter kan skaffes i større mængder.

Rubber sheets from China are excellent alternatives to European sheets at very favorable prices. Should not be understood as a substitute for European qualities. The sheets are good alternatives for most common tasks. They can be used for: vehicles, animal transport, workshop floors and much more.

Cannot be recommended for high-quality seals with high demands on tolerances and mechanical strength. In case of doubt please compare the technical descriptions. The sheets have higher tolerances on thickness than the European ones.

The rubber sheets are delivered on rolls wrapped in plastic. Many other qualities are available if large quantities are required.





NR-SBR gummimåtte *NR-SBR rubber sheet*

Prisgunstig gummiplade til almen brug, hvor der ikke stilles større krav til trækstyrke. Bruges til pakninger, mellemlæg m.m.
Commercial rubber mat for normal use, where there are no specific demands on tensile strength. Useful for eg. seals.

Material: NR - SBR

Colour: Sort *Black*

Quality: Kommerciel *Commercial*

Varenr. <i>Item no.</i>	Bredde <i>Width</i>	Længde <i>Length</i>	Tykkelse <i>Thickness</i>	Indlæg <i>Insertion</i>	Hårdhed <i>Hardness</i>	Densitet <i>Density</i>	Forlængelse <i>Elongation</i>	Arbejds- temperatur <i>Working temperature</i>	Trækstyrke <i>Tensile strength</i>
38.400-2	1.400 mm	20.000 mm	2 mm	1	SH 70	1,55 g/cm ³	200%	-20 +70 °C	4 MPa
38.400-3	1.400 mm	20.000 mm	3 mm	1	SH 70	1,55 g/cm ³	200%	-20 +70 °C	4 MPa
38.400-4	1.400 mm	20.000 mm	4 mm	1	SH 70	1,55 g/cm ³	200%	-20 +70 °C	4 MPa
38.400-5	1.400 mm	10.000 mm	5 mm	1	SH 70	1,55 g/cm ³	200%	-20 +70 °C	4 MPa
38.400-6/650	650 mm	10.000 mm	6 mm	2	SH 70	1,55 g/cm ³	200%	-20 +70 °C	4 MPa
38.400-6	1.400 mm	10.000 mm	6 mm	2	SH 70	1,55 g/cm ³	200%	-20 +70 °C	4 MPa
38.400-8	1.400 mm	10.000 mm	8 mm	2	SH 70	1,55 g/cm ³	200%	-20 +70 °C	4 MPa
38.400-10	1.400 mm	10.000 mm	10 mm	2	SH 70	1,55 g/cm ³	200%	-20 +70 °C	4 MPa
38.400-12	1.400 mm	10.000 mm	12 mm	2	SH 70	1,55 g/cm ³	200%	-20 +70 °C	4 MPa
38.400-15	1.400 mm	5.000 mm	15 mm	0	SH 70	1,55 g/cm ³	200%	-20 +70 °C	4 MPa
38.400-20	1.400 mm	5.000 mm	20 mm	0	SH 70	1,55 g/cm ³	200%	-20 +70 °C	4 MPa
38.400-25	1.400 mm	5.000 mm	25 mm	0	SH 70	1,55 g/cm ³	200%	-20 +70 °C	4 MPa

Blød paragummi måtte *Soft para rubber sheet*

Meget blød, meget elastisk, stor friktion.
Very soft. Highly elastic, good friction.

Material: NR

Colour: Rød *Red*

Quality: Kommerciel *Commercial*

Varenr. <i>Item no.</i>	Bredde <i>Width</i>	Længde <i>Length</i>	Tykkelse <i>Thickness</i>	Indlæg <i>Insertion</i>	Hårdhed <i>Hardness</i>	Densitet <i>Density</i>	Forlængelse <i>Elongation</i>	Arbejds- temperatur <i>Working temperature</i>	Trækstyrke <i>Tensile strength</i>
38.401-2	1.400 mm	10.000 mm	2 mm	0	SH 40	1,1 - 1,25 g/cm ³	600%	-20 +90 °C	18 MPa
38.401-3	1.400 mm	10.000 mm	3 mm	0	SH 40	1,1 - 1,25 g/cm ³	600%	-20 +90 °C	18 MPa
38.401-4	1.400 mm	10.000 mm	4 mm	0	SH 40	1,1 - 1,25 g/cm ³	600%	-20 +90 °C	18 MPa
38.401-5	1.400 mm	10.000 mm	5 mm	0	SH 40	1,1 - 1,25 g/cm ³	600%	-20 +90 °C	18 MPa
38.401-6	1.400 mm	10.000 mm	6 mm	0	SH 40	1,1 - 1,25 g/cm ³	600%	-20 +90 °C	18 MPa
38.401-10	1.400 mm	10.000 mm	10 mm	0	SH 40	1,1 - 1,25 g/cm ³	600%	-20 +90 °C	18 MPa
38.401-15	1.400 mm	5.000 mm	15 mm	0	SH 40	1,1 - 1,25 g/cm ³	600%	-20 +90 °C	18 MPa

EPDM gummiplade *EPDM rubber plate*

Meget god ozon- og vejrbestandighed. God temperaturrestandighed.
With high resistance to ozone and climate. Good temperature resistance.

Material: 30% EPDM

Colour: Sort *Black*

Quality: Kommerciel *Commercial*

Varenr. <i>Item no.</i>	Bredde <i>Width</i>	Længde <i>Length</i>	Tykkelse <i>Thickness</i>	Indlæg <i>Insertion</i>	Hårdhed <i>Hardness</i>	Densitet <i>Density</i>	Forlængelse <i>Elongation</i>	Arbejds- temperatur <i>Working temperature</i>	Trækstyrke <i>Tensile strength</i>
38.402-0,5	1.200 mm	20.000 mm	0,5 mm	0	SH 70	1,4 g/cm ³	300%	-30 +100 °C	5 MPa
38.402-1 ●	1.400 mm	20.000 mm	1 mm	0	SH 70	1,4 g/cm ³	300%	-30 +100 °C	5 MPa
38.402-2 ●	1.400 mm	10.000 mm	2 mm	0	SH 70	1,4 g/cm ³	300%	-30 +100 °C	5 MPa
38.402-3 ●	1.400 mm	10.000 mm	3 mm	0	SH 70	1,4 g/cm ³	300%	-30 +100 °C	5 MPa
38.402-4 ●	1.400 mm	10.000 mm	4 mm	0	SH 70	1,4 g/cm ³	300%	-30 +100 °C	5 MPa
38.402-5 ●	1.400 mm	10.000 mm	5 mm	0	SH 70	1,4 g/cm ³	300%	-30 +100 °C	5 MPa

● Ozonbestandighed 200 pphm
Ozone resistance 200 pphm

CR gummiplade *CR rubber plate*

God vejr/vind- og ozonbestandighed. Egnede hvor der ikke stilles krav til træk/rivstyrke. Betinget oliebestandig.
Good climate resistance. Used where there are no specific demands to tensile strength. Conditional oil resistant.

Materiale *Material:* CR

Colour: Sort *Black*

Quality: Kommerciel *Commercial*

Varenr. <i>Item no.</i>	Bredde <i>Width</i>	Længde <i>Length</i>	Tykkelse <i>Thickness</i>	Indlæg <i>Insertion</i>	Hårdhed <i>Hardness</i>	Densitet <i>Density</i>	Forlængelse <i>Elongation</i>	Arbejds- temperatur <i>Working temperature</i>	Trækstyrke <i>Tensile strength</i>
38.403-2	1.400 mm	20.000 mm	2 mm	0	SH 65	1,55 g/cm ³	280%	-30 +70 °C	3,5 MPa
38.403-3	1.400 mm	20.000 mm	3 mm	0	SH 65	1,55 g/cm ³	280%	-40 +90 °C	3,5 MPa
38.403-4	1.400 mm	20.000 mm	4 mm	0	SH 65	1,55 g/cm ³	280%	-40 +90 °C	3,5 MPa
38.403-5	1.400 mm	10.000 mm	5 mm	0	SH 65	1,55 g/cm ³	280%	-40 +90 °C	5 MPa
38.403-6	1.400 mm	10.000 mm	6 mm	0	SH 65	1,55 g/cm ³	280%	-40 +90 °C	5 MPa
38.403-8	1.400 mm	10.000 mm	8 mm	0	SH 65	1,55 g/cm ³	280%	-40 +90 °C	3,5 MPa

NBR / Nitril gummiplade *NBR / Nitrile rubber plate*

Prisgunstig sort nitril med gode mekaniske egenskaber. Egnede til alle alfatiske og aromatiske olier og benzin.
With good mechanical properties. Recommended for alifatic and aromatic oils and petrol.

Material: NBR

Colour: Sort *Black*

Quality: Kommerciel *Commercial*

Varenr. <i>Item no.</i>	Bredde <i>Width</i>	Længde <i>Length</i>	Tykkelse <i>Thickness</i>	Indlæg <i>Insertion</i>	Hårdhed <i>Hardness</i>	Densitet <i>Density</i>	Forlæn- gelse <i>Elongation</i>	Arbejds- temperatur <i>Working temperature</i>	Trækstyrke <i>Tensile strength</i>
38.404-2	1.400 mm	20.000 mm	2 mm	0	SH 70	1,49 g/cm ³	330%	-30 +70 °C	10 MPa
38.404-3	1.400 mm	20.000 mm	3 mm	0	SH 70	1,49 g/cm ³	330%	-30 +70 °C	10 MPa
38.404-4	1.400 mm	20.000 mm	4 mm	0	SH 70	1,49 g/cm ³	330%	-30 +70 °C	10 MPa
38.404-5	1.400 mm	10.000 mm	5 mm	0	SH 70	1,49 g/cm ³	330%	-30 +70 °C	10 MPa
38.404-10	1.400 mm	10.000 mm	10 mm	0	SH 70	1,49 g/cm ³	330%	-30 +70 °C	10 MPa
38.404-20 *	1.400 mm	5.000 mm	20 mm	0	SH 70	1,49 g/cm ³	330%	-30 +70 °C	10 MPa

* Skaffevare *Special order item*

Slid-gummi plade *Wearing/abrasion rubber sheet*

Høj træk/rivstyrke. Egnede til alle stærkt slidende applikationer, grusgrave, sandblæsekabiner.
With high tensile strength. Recommended for wearing application, gravel pits, sandblasting.

Material: NR-SBR

Colour: Sort *Black*

Varenr. <i>Item no.</i>	Bredde <i>Width</i>	Længde <i>Length</i>	Tykkelse <i>Thickness</i>	Indlæg <i>Insertion</i>	Hårdhed <i>Hardness</i>	Densitet <i>Density</i>	Forlængelse <i>Elongation</i>	Arbejds- temperatur <i>Working temperature</i>	Trækstyrke <i>Tensile strength</i>
38.405-6	1.400 mm	10.000 mm	6 mm	0	SH 60	1,2 g/cm ³	400%	-30 +70 °C	15 MPa
38.405-8	1.400 mm	10.000 mm	8 mm	0	SH 60	1,2 g/cm ³	400%	-30 +70 °C	15 MPa
38.405-10	1.400 mm	10.000 mm	10 mm	0	SH 60	1,2 g/cm ³	400%	-30 +70 °C	15 MPa
38.405-10X *	2.000 mm	10.000 mm	10 mm	0	SH 60	1,2 g/cm ³	400%	-30 +70 °C	15 MPa
38.405-15	1.400 mm	10.000 mm	15 mm	0	SH 60	1,2 g/cm ³	400%	-30 +70 °C	15 MPa
38.405-20 *	1.400 mm	5.000 mm	20 mm	0	SH 60	1,2 g/cm ³	400%	-30 +70 °C	15 MPa
38.405-40 *	1.200 mm	7.000 mm	40 mm	0	SH 60	1,2 g/cm ³	400%	-30 +70 °C	15 MPa

Silikoneplade *Silicone sheet*

Material: FDA Silikone

Varenr. <i>Item no.</i>	Vidde <i>Width</i>	Længde <i>Length</i>	Bredde <i>Thickness</i>	Farve <i>Colour</i>	Hårdhed <i>Hardness</i>	Densitet <i>Density</i>	Forlængelse <i>Elongation</i>	Arbejds- temperatur <i>Working temperature</i>	Trækstyrke <i>Tensile strength</i>
38.406-2T	1.200 mm	10.000 mm	2 mm	Transparent	SH 60	1,25 g/cm ³	450%	-40 +200 °C	6 MPa
38.406-3T	1.200 mm	10.000 mm	3 mm	Transparent	SH 60	1,25 g/cm ³	450%	-40 +200 °C	6 MPa
38.406-5T	1.200 mm	10.000 mm	5 mm	Transparent	SH 60	1,25 g/cm ³	450%	-40 +200 °C	6 MPa
38.406-3H	1.200 mm	10.000 mm	3 mm	Hvid <i>White</i>	SH 60	1,3 g/cm ³	300%	-40 +250 °C	6 MPa

Viton-gummi

Varenr. <i>Item no.</i>	Tykkelse <i>Thickness</i>	Bredde <i>Width</i>	Længde <i>Length</i>	Indlæg <i>Insertion</i>	Hårdhed <i>Hardness</i>	Forlængelse <i>Elongation</i>	Trækstyrke <i>Tensile strength</i>	Min. order
38.429-2 *	2 mm	1.200 mm	10.000 mm	0	SH 70	250%	7 MPa	12 m ²

* Skaffevare *Special order item*

Pyramidemåtte *Pyramidal rubber sheet*

Måtte til industrigulve og maskinområder, varehuse og trafikerede områder. Skridsikker overflade.

Mat for industrial floors and machine areas, warehouses and trafficked areas. Non-slip surface.

Material: SBR

Colour: Sort *Black*

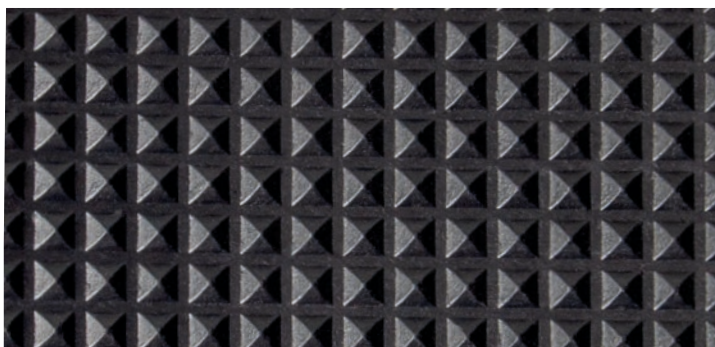

Varenr. <i>Item no.</i>	Bredde <i>Width</i>	Længde <i>Length</i>	Tykkelse <i>Thickness</i>	Indlæg <i>Insertion</i>	Hårdhed <i>Hardness</i>	Densitet <i>Density</i>	Forlængelse <i>Elongation</i>	Arbejds- temperatur <i>Working temperature</i>	Trækstyrke <i>Tensile strength</i>
38.432	1.200 mm	10.000 mm	3 mm	0	SH 65 - 70	1,5 g/cm ³	200	-20 +70 °C	3 MPa

Knop-gummimåtte *Studded flooring*

Knopmåtte, anbefales til trafikerede arealer, metro, lufthavne, supermarkeder, elevatorer, busser, toge, lastbiler, både m.m.

Studded flooring, recommended for high traffic areas such as metro, airports, supermarkets, lifts, buses, trains, trucks, boats.

Material: SBR

Quality: Kommerciel *Commercial*

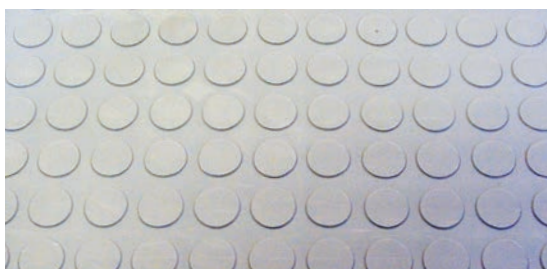

Varenr. <i>Item no.</i>	Bredde <i>Width</i>	Længde <i>Length</i>	Tykkelse <i>Thickness</i>	Indlæg <i>Insertion</i>	Farve <i>Color</i>	Hårdhed <i>Hardness</i>	Densitet <i>Density</i>	Forlængelse <i>Elongation</i>	Arbejds- temperatur <i>Working temperature</i>	Trækstyrke <i>Tensile strength</i>
38.427-3CXL	1.400 mm	10.000 mm	3,5 mm	0	Sort <i>Black</i>	SH 65-70	1,5 g/cm ³	150%	-20 +70 °C	3 MPa
38.427-3GC	1.200 mm	10.000 mm	3,5 mm	0	Lysegrå <i>Light grey</i>	SH 65-70	1,6 g/cm ³	150%	-20 +70 °C	3 MPa

Finriflet gummi mat *Fine ribbed rubber mat*

Finriflet, skridsikker gummi mat til kabiner, arbejdsborde, hylder, gangarealer, køretøjer, sportsaktiviteter eller udstillinger.
Fine-ribbed rubber mat. Non-slip coverings for cabins, working benches, shelves, corridors, vehicles, sporting facilities or exhibition floors.

Material: NR/SBR

Ingen regenereret gummi anvendt. *No regenerated rubber used.*

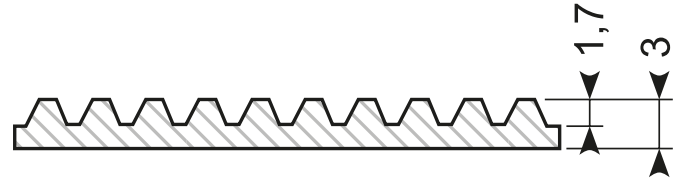
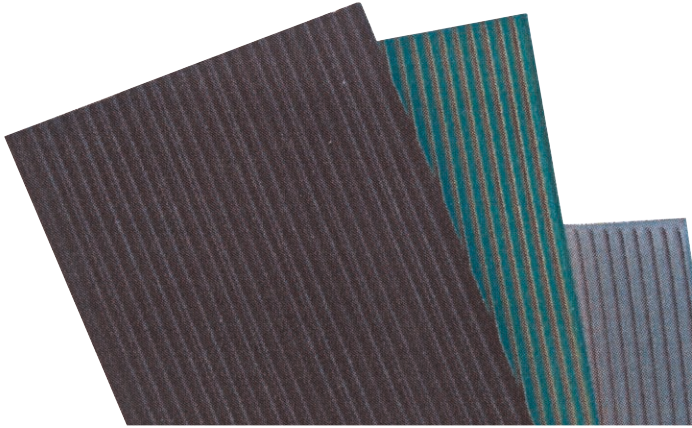

Varenr. Item no.	Bredde Width	Længde Length	Tykkelse Thick- ness	Indlæg Insertion	Farve Color	Hårdhed Hardness	Densitet Density	Forlæn- gelse Elonga- tion	Arbejds- temperatur Working temperature	Træk- styrke Tensile strength	Bemærk Note
38.407-3X	1.200 mm	20.000 mm	3 mm	0	Sort Black	SH 70	1,46 g/cm ³	200%	-20 +70 °C	4 MPa	100% virgin quality SBR
38.407-3	1.400 mm	20.000 mm	3 mm	0	Sort Black	SH 70	1,46 g/cm ³	200%	-20 +70 °C	4 MPa	100% virgin quality SBR
38.407-3C	1.400 mm	20.000 mm	3 mm	0	Sort Black	SH 70	1,6 g/cm ³	280%	-10 +70 °C	3,5 MPa	
38.407-3G	1.400 mm	20.000 mm	3 mm	0	Grå Grey	SH 70	1,6 g/cm ³	350%	-10 +70 °C	5 MPa	
38.407-3XL	1.800 mm	10.000 mm	3,5 mm	0	Sort Black	SH 70	1,46 g/cm ³	200%		4 MPa	

Mellemriflet busmatte *Medium-ribbed bus mat*

Egnet til gulv og vægbeklædning til busser, både, dyretransport, værksteder mm.
Recommended for floors and walls for buses, boats, animal transport, work shops.

Colour: Sort *black*

Quality: Kommerciel *Commercial*

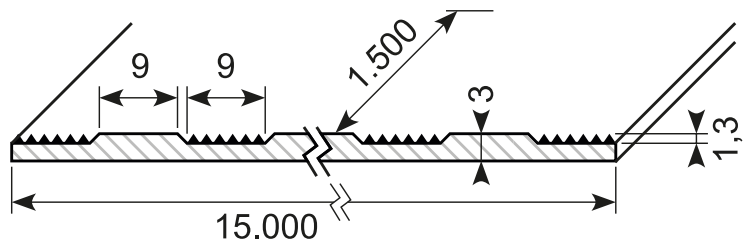
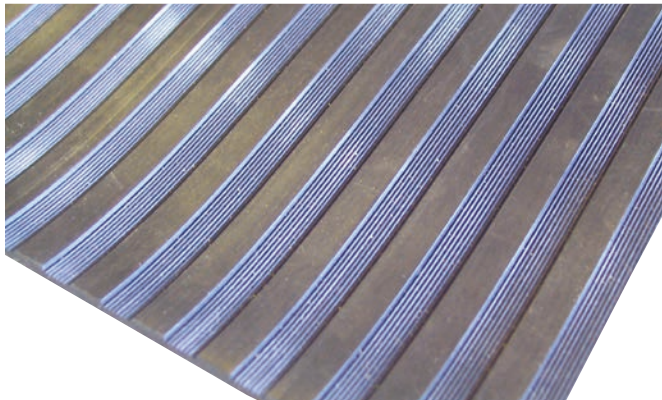

Varenr. Item no.	Bredde Width	Længde Length	Tykkelse Thickness	Materiale Material	Indlæg Insertion	Hårdhed Hardness	Densitet Density	Forlængelse Elongation	Arbejds- temperatur Working temperature	Trækstyrke Tensile strength
38.418	1.500 mm	15.000 mm	3 mm	NR / SBR	0	SH 70	1,6 g/cm ³	280%	-10 +70 °C	3,5 MPa
38.418N	1.500 mm	15.000 mm	3 mm	NBR	0	SH 70	1,45 g/cm ³	250%	-10 +70 °C	6 MPa

Bredriflet busmåtte *Wide-ribbed bus mat*

Egnet til gulv og vægbeklædning til busser, både, dyretransport, værksteder mm.

Recommended for floors and walls for buses, boats, animal transport, work shops

Material: SBR = Natur SBR

Colour: Sort *black*

Quality: Kommerciel *Commercial*

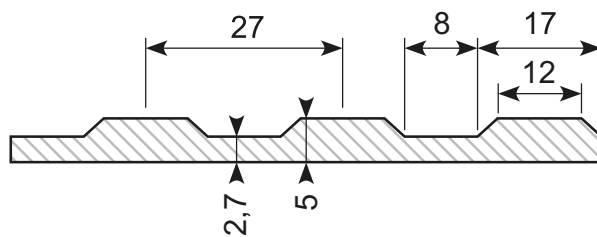
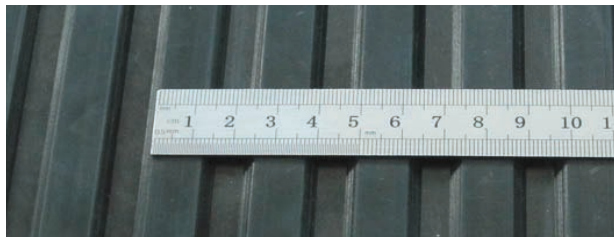

Varenr. <i>Item no.</i>	Bredde <i>Width</i>	Længde <i>Length</i>	Tykkelse <i>Thickness</i>	Indlæg <i>Insertion</i>	Hårdhed <i>Hardness</i>	Densitet <i>Density</i>	Forlængelse <i>Elongation</i>	Arbejds- temperatur <i>Working temperature</i>	Trækstyrke <i>Tensile strength</i>
38.434A	1.200 mm	10.000 mm	5 mm	0	SH 65-70	1,5 g/cm ³	200%	-25 +70 °C	3 MPa

Bredriflet busmåtte *Wide-ribbed bus mat*

Egnet til gulv og vægbeklædning til busser, både, dyretransport, værksteder mm.

Recommended for floors and walls for buses, boats, animal transport, work shops

Material: SBR = Natur SBR

Colour: Sort *black*

Quality: Kommerciel *Commercial*

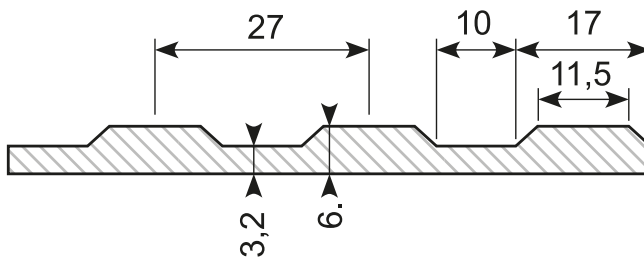

Udgår når solgt

Discontinued when sold

Varenr. <i>Item no.</i>	Bredde <i>Width</i>	Længde <i>Length</i>	Tykkelse <i>Thickness</i>	Indlæg <i>Insertion</i>	Hårdhed <i>Hardness</i>	Densitet <i>Density</i>	Forlængelse <i>Elongation</i>	Arbejds- temperatur <i>Working temperature</i>	Trækstyrke <i>Tensile strength</i>
38.434	1.200 mm	10.000 mm	6 mm	0	SH 65-70	1,5 g/cm ³	200%	-25 +70 °C	3 MPa

Bredriflet let XL busmåtte *Wide-ribbed light XL bus mat*

Egnet til gulv og vægbeklædning til busser, både, dyretransport, værksteder mm.

Recommended for floors and walls for buses, boats, animal transport, workshops.

Material: NR/SBR = Natur SBR

Colour: Sort *black*

Quality: Kommerciel *Commercial*

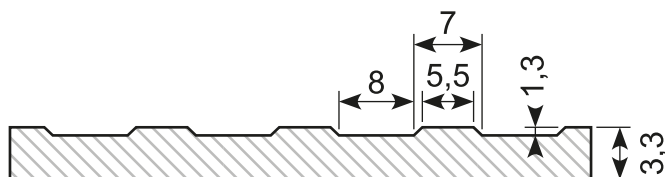
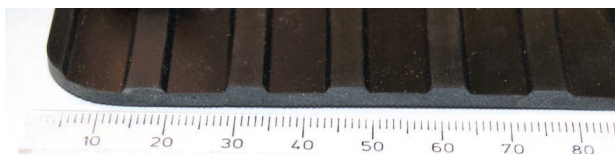

Varenr. <i>Item no.</i>	Bredde <i>Width</i>	Længde <i>Length</i>	Tykkelse <i>Thickness</i>	Indlæg <i>Insertion</i>	Hårdhed <i>Hardness</i>	Densitet <i>Density</i>	Forlængelse <i>Elongation</i>	Arbejds- temperatur <i>Working temperature</i>	Trækstyrke <i>Tensile strength</i>
38.419C	1.400 mm	20.000 mm	3 (3,3) mm	0	SH 65	1,5 g/cm ³	200%	-25 +70 °C	3 MPa
38.435C <i>Discontinued when sold</i>	1.600 mm	10.000 mm	5 mm	0	SH 65	1,5 g/cm ³	200%	-25 +70 °C	3 MPa

Bredriflet busmåtte *Wide-ribbed bus mat*

Egnet til gulv og vægbeklædning til busser, både, dyretransport, værksteder mm.

Recommended for floors and walls for buses, boats, animal transport, workshops.

Material: NR/SBR = Natur / SBR

- **Nyt gummi *New rubber*:** ingen regenereret gummi anvendt.
No regenerated rubber used.
- **C:** Kommerciel kvalitet *Commercial quality*

Colour: Sort *black*

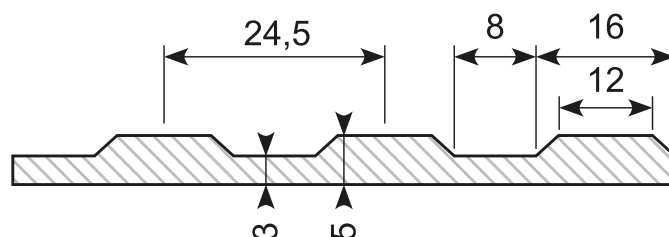

Varenr. <i>Item no.</i>	Bredde <i>Width</i>	Længde <i>Length</i>	Tykkelse <i>Thickness</i>	Indlæg <i>Insertion</i>	Kvalitet <i>Quality</i>	Hårdhed <i>Hardness</i>	Densitet <i>Density</i>	Forlængelse <i>Elongation</i>	Arbejds- temperatur <i>Working temperature</i>	Træk- styrke <i>Tensile strength</i>
38.420CX <i>Discontinued when sold</i>	2.000 mm	10.000 mm	5 mm	0	Commercial	SH 65	1,45 g/cm ³	150%	-30 +100 °C	3 MPa
38.420X	2.000 mm	10.000 mm	5 mm	0	New rubber	SH 65	1,35 g/cm ³	200%	-30 +100 °C	5 MPa
38.420XL	2.000 mm	20.000 mm	5 mm	0	New rubber	SH 65	1,35 g/cm ³	200%	-30 +100 °C	5 MPa

Bredriflet busmåtte *Wide-ribbed bus mat*

Egnet til gulv og vægbeklædning til busser, både, dyretransport, værksteder mm.

Recommended for floors and walls for buses, boats, animal transport, workshops.

Material: NR/SBR = Natur / SBR

- **Nyt gummi *New rubber*:** ingen regenereret gummi anvendt.
No regenerated rubber used.
- **C:** Kommerciel kvalitet *Commercial quality*

Colour: Sort *black*

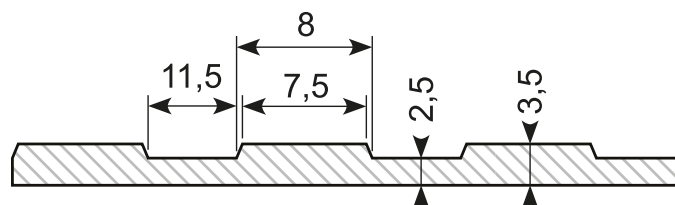

Varenr. <i>Item no.</i>	Bredde <i>Width</i>	Længde <i>Length</i>	Tykkelse <i>Thickness</i>	Indlæg <i>Insertion</i>	Kvalitet <i>Quality</i>	Hårdhed <i>Hardness</i>	Densitet <i>Density</i>	Forlængelse <i>Elongation</i>	Arbejds- temperatur <i>Working temperature</i>	Træk- styrke <i>Tensile strength</i>
38.419A	2.000 mm	10.000 mm	3,5 mm	0	New rubber	SH 65	1,45 g/cm ³	280%	-30 +100 °C	5 MPa
38.436C <i>Discontinued when sold</i>	2.000 mm	10.000 mm	5 mm	0	Commercial	SH 65	1,45 g/cm ³	150%	-30 +100 °C	3 MPa

Hammerslagmätte *Checker mat*

Dørkmatte til industrigulve og maskinområder, varehuse og trafikerede område. Skridsikker overflade. *Checker mat for industrial floors and machine areas, warehouses and trafficked areas. Non-slip surface.*



Material:

- **NBR: Oliebestandig** *Oil resistant*
- **Commercial 1:** NR / SBR - Kommerciel kvalitet *NR / SBR - commercial quality*
- **Commercial 2:** NR / SBR - Kommerciel kvalitet *NR / SBR - commercial quality*

Colour: Sort *Black*

Varenr. <i>Item no.</i>	Bredde <i>Width</i>	Længde <i>Length</i>	Tykkelse <i>Thickness</i>	Indlæg <i>Insertion</i>	Kvalitet <i>Quality</i>	Hårdhed <i>Hardness</i>	Densitet <i>Density</i>	Forlængelse <i>Elongation</i>	Arbejds- temperatur <i>Working temperature</i>	Træk- styrke <i>Tensile strength</i>
38.425-3C	1.400 mm	10.000 mm	3 mm	0	Commercial 1	SH 65	1,5 g/cm ³	250%	-10 +70 °C	3 MPa
38.425-5C	1.400 mm	10.000 mm	5 mm	0	Commercial 1	SH 65	1,5 g/cm ³	250%	-10 +70 °C	3 MPa
38.425N-3	1.400 mm	10.000 mm	3 mm	0	NBR	SH 70	1,45 g/cm ³	250%	-10 +70 °C	6 MPa
38.425N-5	1.400 mm	10.000 mm	5 mm	0	NBR	SH 70	1,45 g/cm ³	250%	-10 +70 °C	6 MPa
38.426-3CX	1.600 mm	10.000 mm	3 mm	0	Commercial 1	SH 65	1,5 g/cm ³	250%	-10 +70 °C	3 MPa
38.426-3C	2.000 mm	10.000 mm	3 mm	0	Commercial 2	SH 70	1,5 g/cm ³	180%	-10 +70 °C	3 MPa
38.426-5CX	1.600 mm	10.000 mm	5 mm	0	Commercial 1	SH 65	1,5 g/cm ³	250%	-10 +70 °C	3 MPa
38.426-5C	2.000 mm	10.000 mm	5 mm	0	Commercial 2	SH 70	1,5 g/cm ³	180%	-10 +70 °C	3 MPa
38.426-8C	2.000 mm	10.000 mm	8 mm	0	Commercial 1	SH 65	1,5 g/cm ³	250%	-10 +70 °C	3 MPa

Hammerslagmätte *Checker mat*

Dørkmatte til industrigulve og maskinområder, varehuse og trafikerede område. Skridsikker overflade. *Checker mat for industrial floors and machine areas, warehouses and trafficked areas. Non-slip surface.*

Material:

- **New rubber 1:** NR/SBR, ingen regenereret gummi anvendt. *NR/SBR, no regenerated rubber used.*
- **New rubber 2:** NR/SBR, ingen regenereret gummi anvendt. *NR/SBR, no regenerated rubber used.*

Colour: Sort *black*

Varenr. <i>Item no.</i>	Bredde <i>Width</i>	Længde <i>Length</i>	Tykkelse <i>Thickness</i>	Indlæg <i>Insertion</i>	Kvalitet <i>Quality</i>	Hårdhed <i>Hardness</i>	Densitet <i>Density</i>	Forlængelse <i>Elongation</i>	Arbejds- temperatur <i>Working temperature</i>	Træk- styrke <i>Tensile strength</i>
38.425-3	1.400 mm	10.000 mm	3 mm	0	New rubber 1	SH 70	1,6 g/cm ³	350%	-10 +70 °C	5 MPa
38.425-5	1.400 mm	10.000 mm	5 mm	0	New rubber 1	SH 70	1,6 g/cm ³	350%	-10 +70 °C	5 MPa
38.426-3XL	1.800 mm	10.000 mm	3 mm	0	New rubber 2	SH 65	1,35 g/cm ³	250%	-10 +70 °C	5 MPa
38.426-3	2.000 mm	10.000 mm	3 mm	0	New rubber 2	SH 65	1,35 g/cm ³	250%	-10 +70 °C	5 MPa
38.426-5	2.000 mm	10.000 mm	5 mm	0	New rubber 2	SH 65	1,35 g/cm ³	250%	-10 +70 °C	5 MPa

Diamant gummimatte *Diamond rubber mat*

Matte til industrigulve og maskinområder, varehuse og trafikerede områder. Skridsikker overflade. *Mat for industrial floors and machine areas, warehouses and trafficked areas. Non-slip surface.*

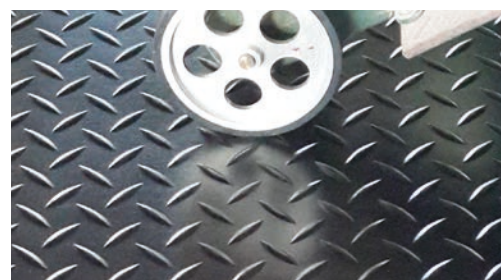

Material:

- **Commercial:** SBR
- **PAK free:** TPE/SBR

Colour: Sort *Black*

Varenr. <i>Item no.</i>	Bredde <i>Width</i>	Længde <i>Length</i>	Tykkelse <i>Thickness</i>	Indlæg <i>Insertion</i>	Kvalitet <i>Quality</i>	Hårdhed <i>Hardness</i>	Densitet <i>Density</i>	Forlængelse <i>Elongation</i>	Arbejds- temperatur <i>Working temperature</i>	Træk- styrke <i>Tensile strength</i>
38.431	1.400 mm	10.000 mm	3 mm	0	Commercial	SH 70	1,5 g/cm ³	200%	-20 +70 °C	3 MPa
38.431-3C	1.800 mm	10.000 mm	3 mm	0	Commercial	SH 65	1,5 g/cm ³	180%	-20 +70 °C	3 MPa
38.431-5C	1.800 mm	10.000 mm	5 mm	0	Commercial	SH 65	1,5 g/cm ³	180%	-20 +70 °C	3 MPa
38.431-3	1.800 mm	10.000 mm	3 mm	0	PAK free <i>Odour free</i>	SH 65	1,4 g/cm ³	200%	-20 +70 °C	3 MPa
38.431-5	1.800 mm	10.000 mm	5 mm	0	PAK free <i>Odour free</i>	SH 65	1,4 g/cm ³	200%	-20 +70 °C	3 MPa

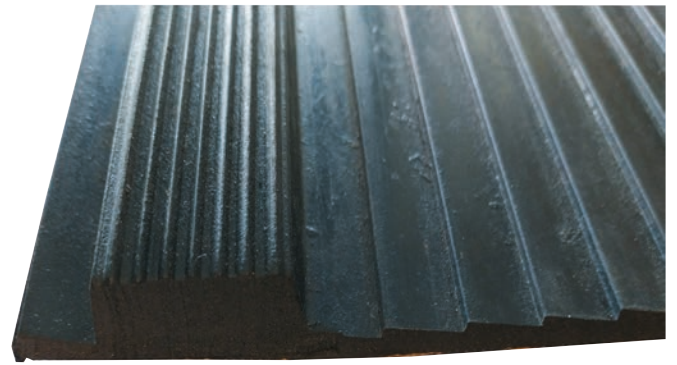

37.250

Rampemåtte *Rear board mat, 12 mm*

Materiale *Material*: SBR

Hårdhed *Hardness*: SH A 65

Densitet *Density*: 1,25 g/cm³

Forlængelse *Elongation*: 400%

Arbejdstemperatur *Working temperature*: -30 +80 °C

Trækstyrke *Tensile strength*: 8 MPa

Tykkelse *Thickness*: 7,5/12 mm

Ribbredde *Rib width*: 30-35 mm

Bredde *Width*: 1.750 mm

Højde *Height*: 1.550 mm

Vægt *Weight*: 28 kg

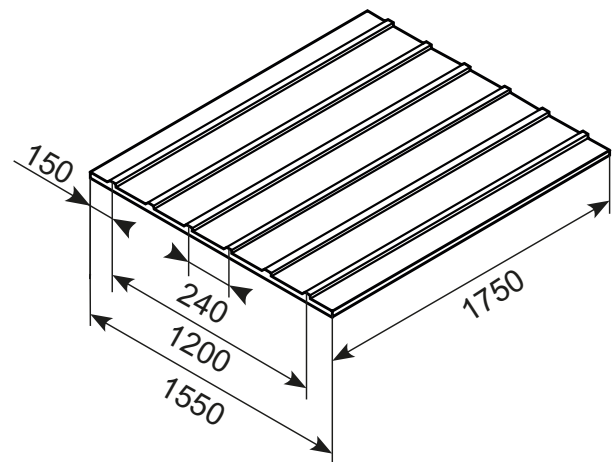
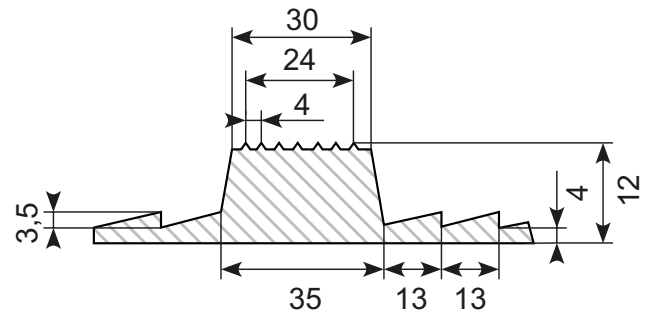

37.251

Rampemåtte *Rear board mat, 20 mm*

Materiale *Material*: SBR

Hårdhed *Hardness*: SH A 65

Densitet *Density*: 1,50 g/cm³

Forlængelse *Elongation*: 300%

Arbejdstemperatur *Working temperature*: -30 +70 °C

Trækstyrke *Tensile strength*: 5 MPa

Tykkelse *Thickness*: 7,5/20 mm

Ribbredde *Rib width*: 28-32 mm

Bredde *Width*: 2.400 mm

Højde *Height*: 1.200 mm

Vægt *Weight*: 38-40 kg

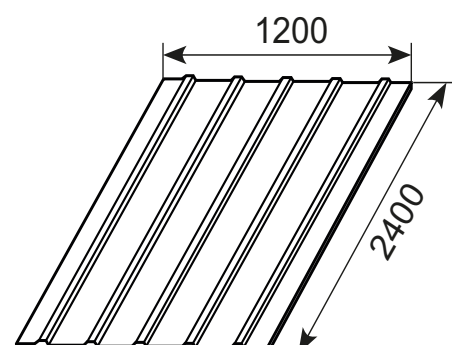
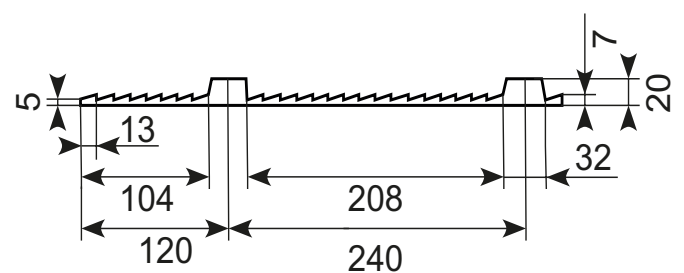

Ergo Solid

Ergo Solid er en modulmåtte af en speciel nitrilgummiblanding, som gør den både varmebestandig og modstandsdygtig overfor olier, fedt og kemikalier. Modulerne kan nemt bygges sammen til den ønskede størrelse, og de kan også suppleres med skrå kanter for at reducere snublerisikoen. Kanterne fås også i gul for markering af arbejdsområder m.v. Ergo solid er en slidstærk måtte med en skridsikker overflade. Stabile knopper på undersiden løfter matten, hvilket sørger for dræning og ventilation mod gulvet. Ergo solid har en rigtig god bæreevne og en lukket overflade, der gør den nem at holde ren.

Ergo Solid is a modular mat made of a special nitrile rubber compound that makes it both heat resistant and resistant to oils, greases and chemicals. The modules can be easily assembled to the desired size and can also be supplemented with chamfered edges to reduce the risk of tripping. The edges are also available in yellow for marking work areas etc. Ergo solid is a durable mat with a non-slip surface. Sturdy knobs on the underside lift the mat, providing drainage and ventilation to the floor. Ergo solid has a very good carrying capacity and a closed surface that makes it easy to keep clean.

Material: Nitril

Colour: Sort *Black*

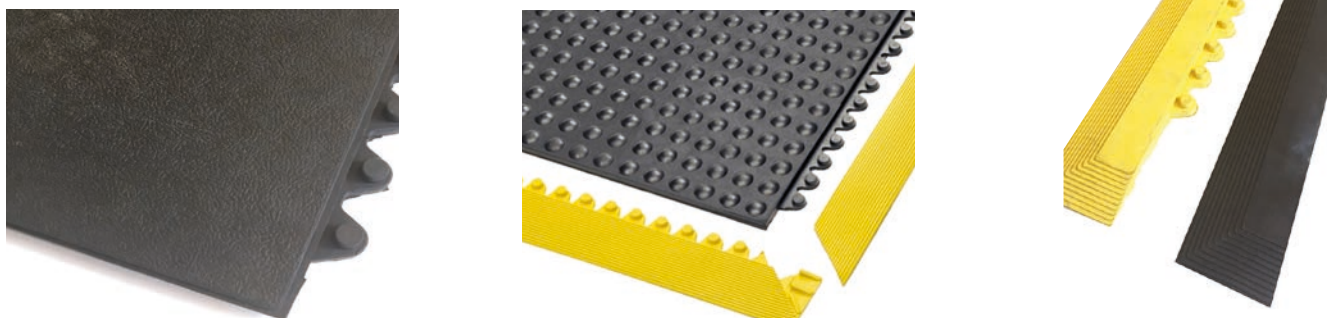

Varenr. <i>Item no.</i>	Beskrivelse <i>Description</i>	Størrelse <i>Size</i>	Vægt <i>Weight</i>
38.9726230	Ergo Solid måtte <i>Ergo Solid mat</i>	910 x 910 x 17 mm	8,2 kg
38.9730030 ●	Sort skråkant - han <i>Black chamfer - male</i>	76 x 910 mm	1 kg
38.9730030S ●	Sort skråkant - hun <i>Black chamfer - female</i>	76 x 910 mm	
38.9750030	Samlestykke <i>Connecting piece</i>	31 x 230 mm	0,1 kg

● **BEMÆRK:** Ved kant rundt om hele matten bruges 2 han- og 2 hun-skråkanter.

Grundmatten har udvendige tappe på 2 sider.

NOTE: For edging around the entire mat, 2 male and 2 female chamfers are used.

The basic mat has external tabs on 2 sides.

Ergo Bubble

Ergo Bubble matten er en traditionel elastisk og holdbar boblemåtte fremstillet af skum-polyuretan som både er holdbar og holder formen. Mattens overflade og elasticitet er med til at stimulere blodcirkulationen og muskelfunktionen i fødder, ben og ryg og hjælper dermed at forebygge belastningsskader. Ergo Bubble er velegnet til brug overalt i tørre miljøer. De skrå kanter minimerer risikoen for at snuble, mens matten overflade giver god skridsikkerhed. Matten findes i flere standardstørrelser og kan derudover fremstilles efter dine specialmål.

The Ergo Bubble mat is a traditional elastic and durable bubble mat made of foam-polyurethane that is both durable and holds its shape. The mat's surface and elasticity help to stimulate blood circulation and muscle function in the feet, legs and back and thus helping to prevent overuse injuries. Ergo Bubble is suitable for use anywhere in dry environments. The chamfered edges minimise the risk of tripping, while the mat's surface provides good slip resistance. The mat is available in several standard sizes and can also be made to your special dimensions.

Material: Polyurethan

Colour: Mørk grafit *Dark graphite*

Matten kan også skaffes i oliebestandig NBR i størrelserne:

The mat is also available in oil-resistant NBR in the sizes:

650 x 1.400 mm / 950 x 1.500 mm / 950 x 1.800 mm

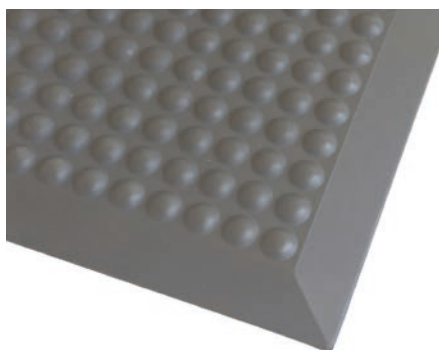

Varenr. <i>Item no.</i>	Størrelse <i>Size</i>	Vægt <i>Weight</i>
38.8100110	650 x 950 x 14 mm	3 kg
38.8100310	650 x 1.850 x 14 mm	6 kg
38.8103110 *	950 x 1.250 x 14 mm	6 kg

* Skaffevare *Special order item*

Ergo Durk

Ergo Durk er en klassisk arbejdspladsmåtte af nitrilgummi med en dørkmønstreret overflade. Bagsiden er af EPDM-cellegummi med lukkede celler. Dermed får du en holdbar og slidstærk måtte med en skridsikker overflade, der er modstandsdygtig over for olie, fedt og kemiske stoffer. Kanterne er affasede for at reducere snublefarer og for at gøre det nemt at køre en vogn op uden at sidde fast. Fås i standardmåtte fra rulle eller i specialmål efter tegning, alt med affasede kanter. Ergo Durk ESD beskytter også følsomt elektronik imod statisk elektricitet. Måtten er godkendt i henhold til SP 2472.

Ergo Durk is a classic work mat made of nitrile rubber with a surface patterned like the deck of a ship. The underside is made of EPDM cellular rubber with closed cells. This gives you a durable and hard-wearing mat with a non-slip surface that is resistant to oil, grease and chemicals. The edges are chamfered to reduce the risk of tripping and to make it easy to drive up a trolley without getting stuck. Available in standard mat from roll or in custom sizes acc. to drawing, all with chamfered edges. Ergo Durk ESD also protects sensitive electronics from static electricity. The mat is approved according to SP 2472.

Material: Nitril / EPDM

Colour: Sort *Black*

Varenr. <i>Item no.</i>	Størrelse <i>Size</i>	Vægt <i>Weight</i>
38.5017530	1.400 x 1.000 x 11 mm	7 kg
38.5017530A *	1.400 x 10.000 x 11 mm	66 kg

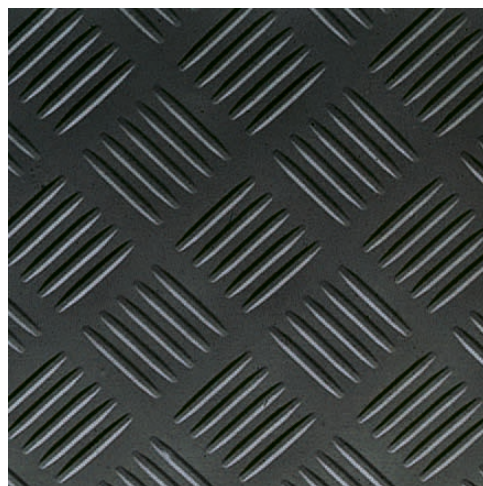

Ergo Dome

En slidstærk måtte i ren naturgummi (SBR). Ergo Dome er velegnet til alle arbejdsmiljøer, fra tørre til tunge industrier. Måtten kan tåle olie, fedt og kemiske stoffer. Den buleformede overflade stimulerer blodcirkulationen og reducerer overbelastningsskader.

A durable mat in pure natural rubber. Ergo Dome is suitable for all working environments, from dry to heavy industries. The mat can withstand oil, grease and chemical substances. The bulge-shaped surface stimulates blood circulation and reduces overuse injuries.

Colour: Sort *Black*

Måtten kan også skaffes i oliebestandig NBR i størrelserne:

The mat is also available in oil-resistant NBR in the sizes:

650 x 1.400 mm / 950 x 1.500 mm

Varenr. <i>Item no.</i>	Størrelse <i>Size</i>	Vægt <i>Weight</i>
38.410200 *	600 x 900 mm	3,2 kg
38.410201	900 x 1.200 mm	4 kg

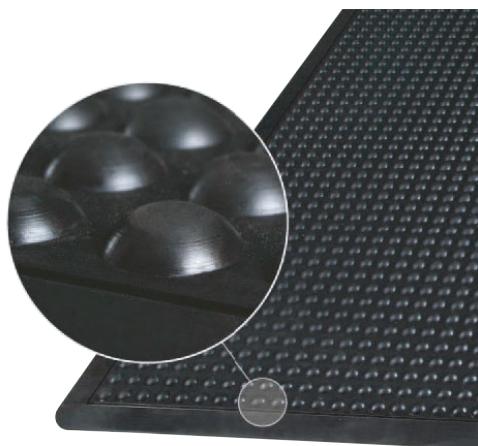

Ergo ring

Ergo ring er en klassisk ringgummimåtte, der effektivt bortdræner væde og spildmateriale, hvilket giver en skridsikker overflade at stå på. Den kan også fungere som en grov stænkmatte i indgangspartier. Den åbne ringkonstruktion skraber effektivt alt groft snavs af, giver maksimal skridsikkerhed og en god aflastning. Navene på bagsiden holder maten på plads og tillader væsken at passere igennem.

Ergo Ring is a classic ring rubber mat that effectively drains away liquid and spills, providing a non-slip surface to stand on. It can also be used as a rough splash mat in entrance areas. The open ring construction effectively scrapes off all coarse dirt, providing maximum slip resistance and a good strain relief. Nails on the back hold the mat in place and allow liquid to pass through.

Material: NR

Colour: Sort *Black*

Måtten kan også skaffes i oliebestandig NBR i størrelserne:

The mat is also available in oil-resistant NBR in the sizes:

400 x 500 mm / 600 x 800 mm

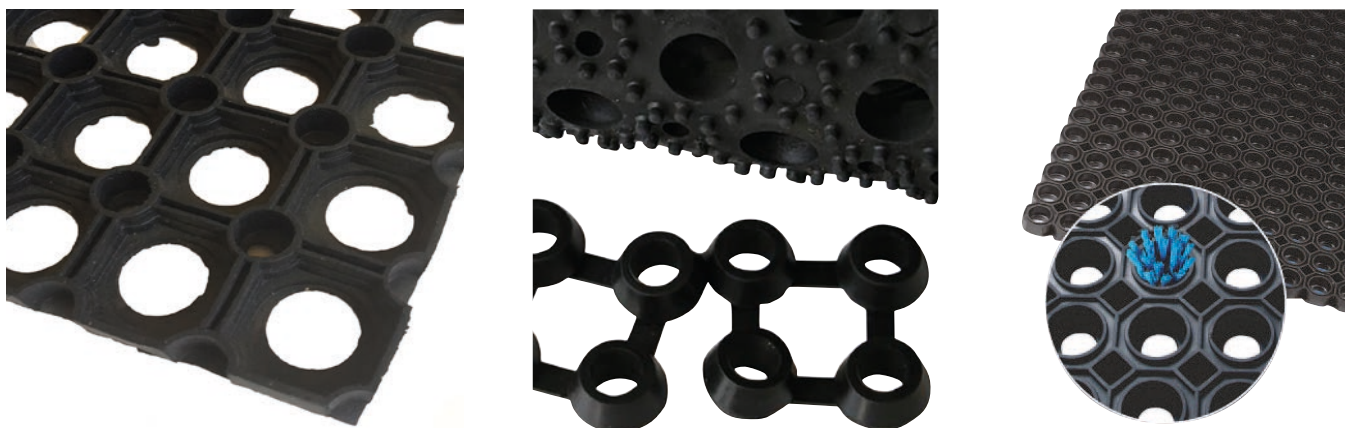

Varenr. <i>Item no.</i>	Beskrivelse <i>Description</i>	Størrelse <i>Size</i>	Vægt <i>Weight</i>
38.9117630	Ergo ring	800 x 1.200 x 23 mm	11 kg
38.9117631	Ergo ring	1.000 x 1.500 x 23 mm	21 kg
38.9110030	Samlestykke <i>Connecting piece</i>		

Ergo Ease

Ergo Ease er en modulmåtte af nitrilgummi som gør den både varmebestandig og modstandsdygtig over for olie, fedt og kemikalier. Pladerne kan sammensættes til den ønskede størrelse uden anvendelse af samlingsstykker. Måtten kan modstå store belastninger og er egnet til de fleste miljøer, både tørre og våde. Den giver ergonomisk aflastning af fødder, ben og ryg samt en høj skridsikkerhed. Stabile knopper på undersiden løfter maten, hvilket sørger for dræning og ventilation mod gulvet. Affasede kanter minimerer risikoen for at snuble. Kanterne fås også i gul for markering af arbejdsområder m.v.

Ergo Ease is a modular mat made of nitrile rubber which makes it both heat resistant and resistant to oil, grease and chemicals. The sheets can be assembled to the desired size without the use of connectors. The mat can withstand heavy loads and is suitable for most environments, both dry and wet. It provides ergonomic relief for feet, legs and back as well as high slip resistance. Stable knobs on the underside lift the mat, providing drainage and ventilation to the floor. Chamfered edges minimise the risk of tripping. The edges are also available in yellow for marking work areas etc.

Material: Nitril

Colour: Sort (måtten kan også skaffes i terracottarød) *Black (the mat is also available in terracotta red)*

Varenr. <i>Item no.</i>	Størrelse <i>Size</i>	Vægt <i>Weight</i>
38.9716230	910 x 910 x 17 mm	8,2 kg



Ergo Classic

Ergo Classic er en arbejdsmatte af vinyl med en ribmønstret overflade som giver god skridsikkerhed (den opfylder R10 DIN 51130-standarden for skridsikkerhed). Mattens konstruktion af mikroceller stimulerer blodcirkulationen i fødder og ben og giver samtidig en god ergonomisk støtte til ben, ryg og hofter. Den er velegnet til tørre miljøer som f.eks. butikker, lagerbygninger og foran arbejdsborde. Affasede kanter minimerer risikoen for at snuble. Ergo Classic har 3 års fuld slitagegaranti. Nem at tilpasse selv med en almindelig tæppekniv.

Ergo Classic is a vinyl work mat with a ribbed surface that provides good slip resistance (it meets the R10 DIN 51130 standard for slip resistance). The mat's microcellular construction stimulates blood circulation in the feet and legs while providing good ergonomic support for the legs, back and hips. It is suitable for dry environments such as shops, warehouses and in front of work desks. Chamfered edges minimise the risk of tripping. Ergo Classic comes with a 3-year full wear warranty. Easy to fit even with a standard carpet cutter.

Material: Vinyl

Colour: Grå *Grey*

Varenr. <i>Item no.</i>	Størrelse <i>Size</i>	Vægt <i>Weight</i>
38.5501110	610 x 18.300 x 9 mm	36 kg
38.5501210	910 x 18.300 x 9 mm	50 kg
38.5501310 *	1.220 x 18.300 x 9 mm	66 kg

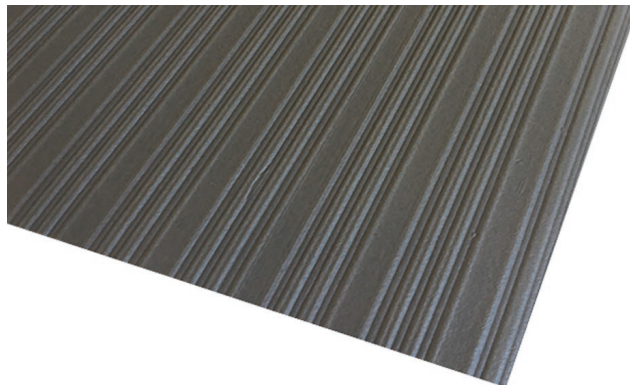

Smudsmatte, diamond *Dirt trapper mat, diamond*

Ekstrem slidstærk matte med gummibagside og overside af groft mønstret polypropylengarn af højeste kvalitet. Skraber effektivt groft snavs væk og absorberer fugt. Den har en skrå gummikant, der tilbageholder snavs og reducerer risikoen for at snuble. Velegnet til både private og offentlige miljøer med stor trafik. Kan spules med højtryksrensere

Extremely durable mat with rubber backing and coarse patterned polypropylene yarn top of highest quality. Effectively scrapes away coarse dirt and absorbs moisture. It has chamfered edges that retains dirt and reduces the risk of tripping. Suitable for both domestic and high-traffic public environments. Can be washed with high-pressure cleaner.

Material: Polypropylen

Colour: Blå (måtten kan også skaffes i grå) *Blue (the mat is also available in grey)*

Varenr. <i>Item no.</i>	Størrelse <i>Size</i>	Vægt <i>Weight</i>
38.623752	600 x 900 x 9 mm	3 kg
38.623750 *	900 x 1.500 x 9 mm	6 kg
38.623764 *	1.200 x 1.800 x 9 mm	9 kg

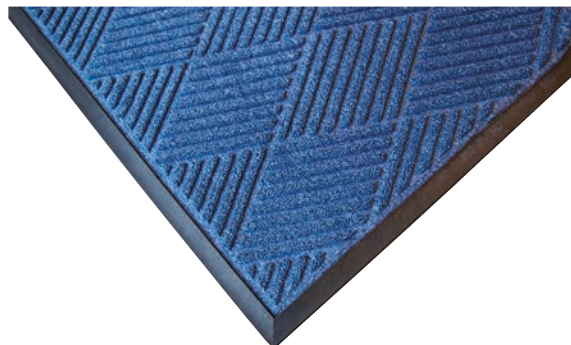

Vibrationsmatte *Vibration mat*

Sort, kommerciel gummiplade. Anvendes mellem maskiner og gulv for at minimere og optage vibrationer. Riller på begge sider. Bæreevne 5 kg/cm²

Black commercial rubber plate. To be used between machines and floor in order to minimize and absorb vibrations. Grooves on both sides. Carrying capacity of 5 kg/cm².

Material: NR/CR

Varenr. <i>Item no.</i>	Tykkelse <i>Thickness</i>	Bredde <i>Width</i>	Længde <i>Length</i>	Indlæg <i>Insertion</i>	Hårdhed <i>Hardness</i>	Vægt <i>Weight</i>
37.400	8,5 mm	500 mm	500 mm	0	SH 45 - 50	5 kg / cm ²

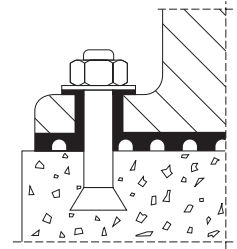
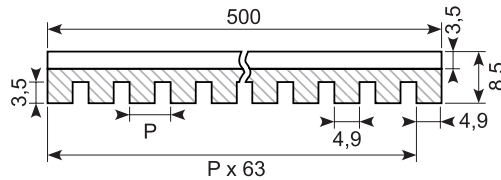

Komåtte *Cow mat*

Material: NR/SBR

Udgår når solgt

Discontinued when sold

Varenr. <i>Item no.</i>	Bredde <i>Width</i>	Længde <i>Length</i>	Tykkelse <i>Thickness</i>	Hårdhed <i>Hardness</i>	Densitet <i>Density</i>	Indlæg <i>Insertion</i>	Forlængelse <i>Elongation</i>	Trækstyrke <i>Tensile strength</i>
38.440-6	2.000 mm	30.000 mm	6 mm	SH 65	1,35 g/cm ³	Nej <i>No</i>	250 %	5 MPa
38.440-6B	2.000 mm	30.000 mm	6 mm	SH 65	1,35 g/cm ³	Ja <i>Yes</i>	250 %	5 MPa
38.440-8	2.000 mm	30.000 mm	8 mm	SH 65	1,35 g/cm ³	Nej <i>No</i>	250 %	5 MPa
38.440-8X	1.250 mm	10.000 mm	8 mm	SH 65	1,45 g/cm ³	Ja <i>Yes</i>		4 MPa
38.440-8A	1.750 mm	21.000 mm	8 mm	SH A 65	1,45 g/cm ³	Ja <i>Yes</i>		4 MPa

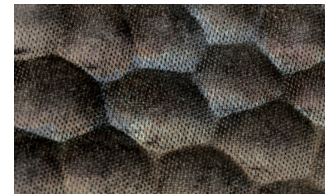

Komåtte *Cow mat*

Material: NR/SBR

Overflade: cirkler uden indlæg, bund: ribbet i længderetning

Surface: circles without insert, bottom: ribbed in longitudinal direction.

Varenr. <i>Item no.</i>	Tykkelse <i>Thickness</i>	Bredde <i>Width</i>	Længde <i>Length</i>
37.260	10 mm	2.000 mm	20.000 mm
37.260B	10 mm	2.400 mm	7.410 mm
37.260C	10 mm	2.400 mm	10.000 mm



Komåtte *Cow mat*

Material: NR/SBR

Overflade: cirkler uden indlæg, bund: ribbet i længderetning

Surface: circles without insert, bottom: ribbed in longitudinal direction.

Varenr. <i>Item no.</i>	Tykkelse <i>Thickness</i>	Bredde <i>Width</i>	Længde <i>Length</i>
37.263	16 mm	2.150 mm	10.000 mm

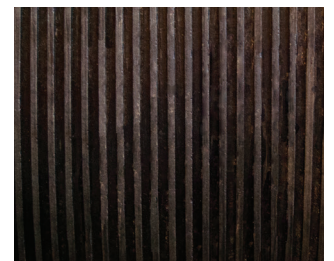
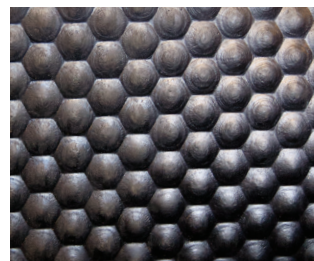

Trailermåtte *Trailer mat*

Varenr. <i>Item no.</i>	Bredde <i>Width</i>	Længde <i>Length</i>	Tykkelse <i>Thickness</i>	Hårdhed <i>Hardness</i>	Densitet <i>Density</i>	Arbejds-temperatur <i>Working temperature</i>	Trækstyrke <i>Tensile strength</i>
38.423-1750 *	1.750 mm	21.000 mm	8 mm	SH 65	1,4 g/cm ³	-25 +70 °C	12 MPa
38.424-1800 *	1.800 mm	21.000 mm	8 mm	SH 65	1,4 g/cm ³	-25 +70 °C	12 MPa

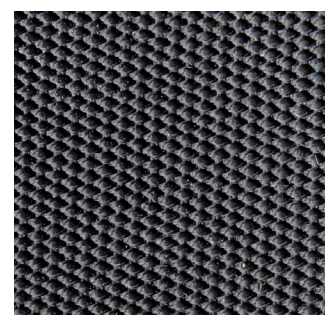

* Skaffevare *Special order item*

Blød transparent PVC *Soft transparent PVC*

Varenr. <i>Item no.</i>	Tykkelse <i>Thickness</i>	Bredde <i>Width</i>	Længde <i>Length</i>	Farve <i>Colour</i>
38.449-750 *	3 mm	750 mm	20.000 mm	
38.449-1200	3 mm	1.200 mm	20.000 mm	Klar <i>Clear</i>
38.449-1600	3 mm	1.600 mm	20.000 mm	Blåtonet <i>Blue tinted</i>
38.450-760 *	4 mm	760 mm	13.000 mm	
38.451-1600	5 mm	1.600 mm	10.000 mm	Blåtonet <i>Blue tinted</i>
38.452-1200 *	7 mm	1.200 mm	10.000 mm	

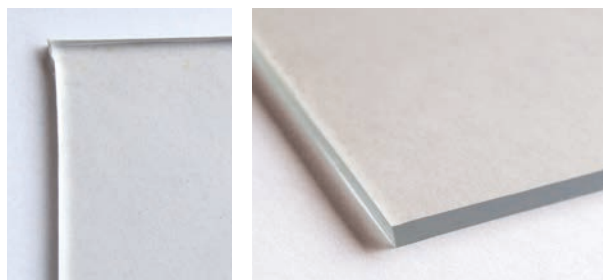

Polyurethanplader *Polyurethane plates*

Bredde *Width*: 2.000 mm

Længde *Length*: 1.000 mm

Varenr. <i>Item no.</i>	Tykkelse <i>Thickness</i>	Hårdhed <i>Hardness</i>	Densitet <i>Density</i>	Forlæn- gelse <i>Elonga- tion</i>	Træk- styrke <i>Tensile strength</i>	Rivstyrke <i>Tear strength</i>	Arbejds- temperatur <i>Working temperature</i>
38.430-5/70	5 mm	SH 70	1,25 g/cm ³	500-600%	30 MPa	50 KN/m	-50 +100 °C
38.430-5/80	5 mm	SH 80	1,25 g/cm ³	450-500%	35 MPa	35 KN/m	-50 +100 °C
38.430-8/70	8 mm	SH 70	1,25 g/cm ³	500-600%	30 MPa	50 KN/m	-50 +100 °C
38.430-8/90	8 mm	SH 90	1,25 g/cm ³	400-450%	40 MPa	90 KN/m	-50 +100 °C
38.430-10/70	10 mm	SH 70	1,25 g/cm ³	500-600%	30 MPa	50 KN/m	-50 +100 °C
38.430-10/90	10 mm	SH 90	1,25 g/cm ³	400-450%	40 MPa	90 KN/m	-50 +100 °C

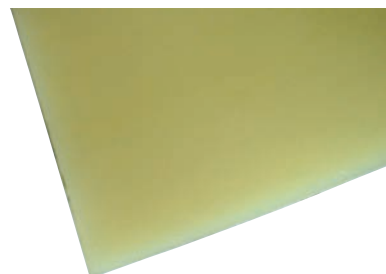

Anti-slip plade *Anti-slip plate*

Material: Gummigranulat *Rubber granules*.

Varenr. <i>Item no.</i>	Tykkelse <i>Thickness</i>	Bredde <i>Width</i>	Længde <i>Length</i>	Min. ordre
38.14572	8 mm	500 mm	5.000 mm	5 m
38.14574	5 mm	1.250 mm	10.000 mm	10 m
38.14574/3	3 mm	1.250 mm	10.000 mm	10 m

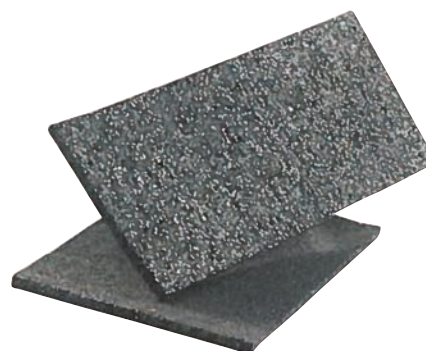

38.9971010

Græsmåtte, grå
Grass mat, grey
900 mm x 16 m

*



38.9971020

Græsmåtte, grøn
Grass mat, green
900 mm x 16 m

*



* Skaffevare *Special order item*

Semperit

Colour: Sort *Black*



Varenr. <i>Item no.</i>	Bredde <i>Width</i>	Længde <i>Length</i>	Tykkelse <i>Thickness</i>	Materiale <i>Material</i>	Hårdhed <i>Hardness</i>	Indlæg <i>Insertion</i>
38.1215N	1.400 mm	20.000 mm	1,5 mm	Nitril	SH 65	1
38.1215	1.400 mm	10.000 mm	1,5 mm	NR / SBR		

Gummikork *Rubber cork*

Material: NR / NBR / NR-SBR

Varenr. <i>Item no.</i>	Størrelse <i>Size</i>	Tykkelse <i>Thickness</i>	Kvalitet <i>Quality</i>	Min. ordre
38.201.5 *	1.000 x 1.000	1,5	1.235	100 m ²
38.202 *	1.000 x 1.000	2	1.235	75 m ²
38.203 *	1.000 x 1.000	3	1.235	50 m ²
38.205 *	1.000 x 1.000	5	1.235	30 m ²

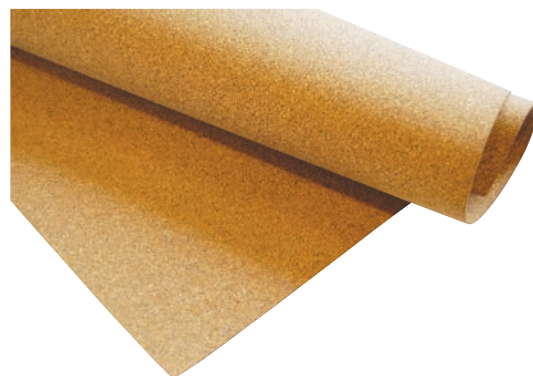

Gummistropper

Rubber straps

Gummistropper bruges som en fleksibel fastgørelse. Stropperne kan bl.a. bruges til at fæstne presenninger til landbrugsmaskiner, lastbiler eller reklameskilte.

Vi tilbyder gummistropper i flere varierende udformninger lige fra T-stropper eller T-stiger til ovale stropper, bagageremme og stigestropper. Vi har også stropper i lange længder som bl.a. kan bruges til fastgørelse i industrien.

Rubber straps are used everywhere as a flexible fastening. The straps can among other things be used for fastening tarpaulins on agricultural machinery, trucks or advertising boards.

We offer rubber straps in different variants - from T-straps or T-ladders to oval straps, luggage straps or ladder straps. We also have straps in long lengths that can be used for fastening in industry.

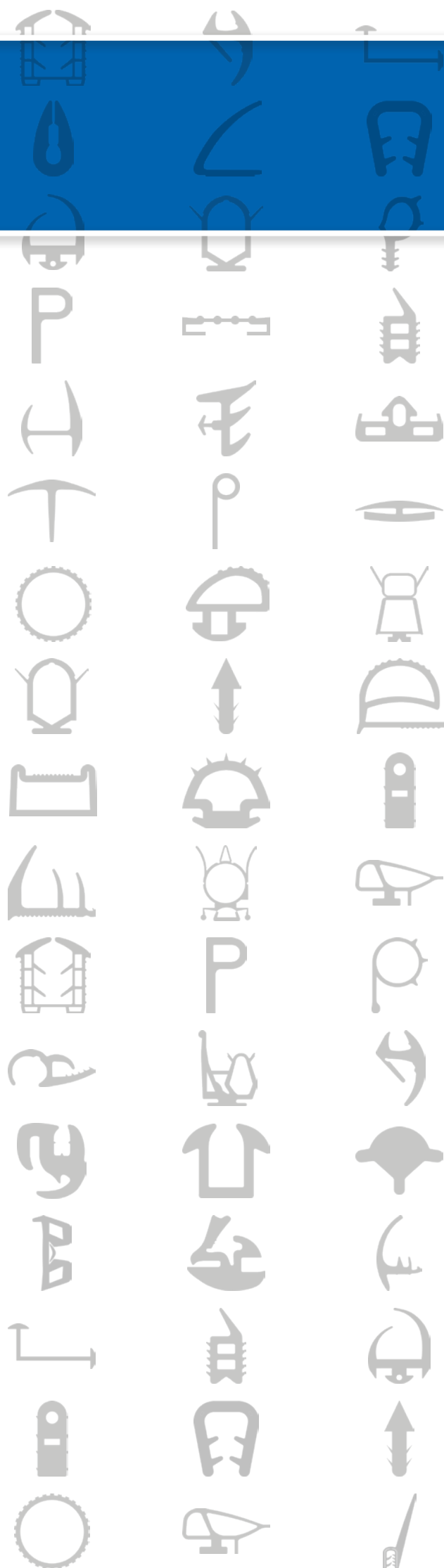

50.241NR

T-strop. Materiale: NR. Længde: 150 mm
T-strap. Material: NR. Length: 150 mm

**50.242NR**

T-stige. Materiale: NR. Længde: 250 mm
T-strap. Material: NR. Length: 250 mm

**50.245NR**

T-stige med to huller. Materiale: NR. Længde: 160 mm
Strap with two holes. Material: NR. Length: 160 mm

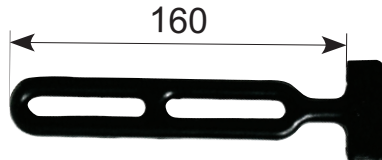
**50.245H**

T-stige med 2 huller. Materiale: Hvid EPDM. **Min. 400 stk.**
Længde: 160 mm
Strap with 2 holes. White EPDM. Length: 160 mm. Min. 400 pcs

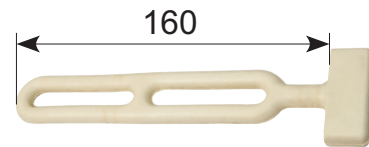
**50.265**

Lille kombi-strop. Materiale: EPDM. Længde: 280 mm
Short strap. Material: EPDM. Length: 280 mm

**50.246-10**

T-stige med 3 huller. Materiale: NR.
Størrelse: 280 x 30 mm. Pakke á 10 stk. Udgår.
Strap with 3 holes. Material: NR. Size: 280 x 30 mm. 10 pcs. Discontinued.

**50.246NR**

T-stige med tre huller. Materiale: NR. Længde: 285 mm
Strap with three holes. Material: NR. Length: 285 mm

**50.266**

Gummistrop, kombi. Materiale: EPDM. Længde: 360 mm
Rubber strap, combi. Material: EPDM. Length: 360 mm.

**50.247NR**

Gummistrop, kombi. Materiale: NR.
Længde: 365 mm / 370 mm
Rubber strap, combi. Material: NR. Length: 365 mm / 370 mm

**50.250**

Stigestrop. Rulle på 10 m.
Materiale: SBR.
Tarpaulin strap, 10 m. Material: SBR.

**50.252J**

HDPE plast fæsteknob, sort.
100 stk. (Grå: 50.252G).
HDPE plastic fastening knob, black. 100 pcs. (Grey: 50.252G).

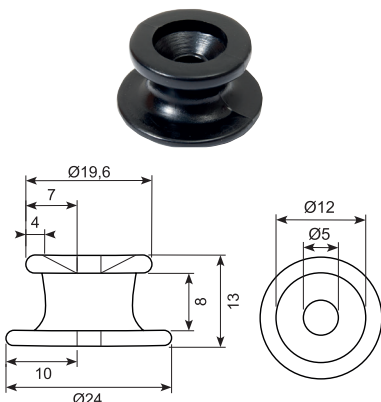
**50.254J**

Sort PE fæsteknob. 1.000 stk. *
i pose. LDPE. Min. 50.000 stk.
Black LDPE knob. 1.000 pcs. per bag. LDPE. Min.: 50.000 pcs.

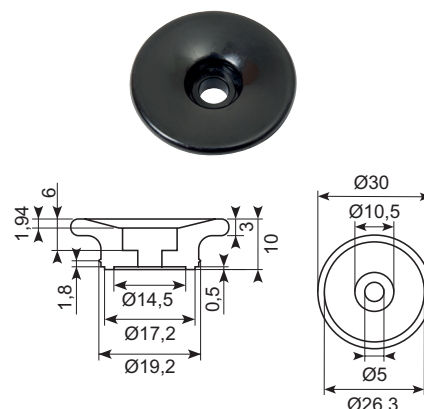
**50.255J**

Grå PE fæsteknob. 1.000 stk.
i pose. LDPE.
Grey PE knob. 1.000 pcs. per bag. LDPE.

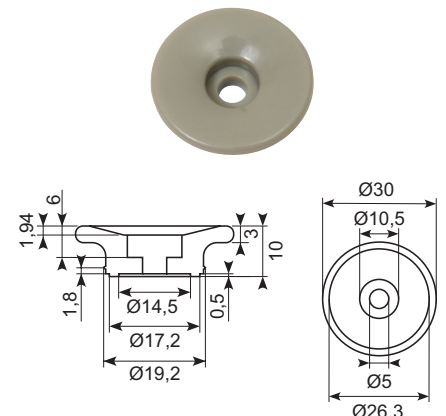

* Skaffevare Special order item

50.275

Stige POP. Materiale: EPDM. Længde: 200 mm
Strap POP. Material: EPDM. Length: 200 mm



50.276

Stige POP. Materiale: EPDM. Længde: 275 mm
Strap POP. Material: EPDM. Length: 275 mm



50.261

Strop, Ø8. Materiale: EPDM. Længde: 200 mm
Strap, Ø8. Material: EPDM. Length: 200 mm



50.244NRS

4-stige. Materiale: NR. Længde: 260 mm
Strap, 4-holes. Material: NR. Length: 260 mm



50.271

Presenningstrop. Materiale: EPDM. Længde: 270 mm
Strap. Material: EPDM. Length: 270 mm



50.244NR

4-stige. Materiale: NR. Længde: 290 mm
Strap, 4-holes. Material: NR. Length: 290 mm



50.269

Rund gummistrop. Materiale: EPDM.
Ø106 / Ø86.
Round strap. Material: EPDM.
Ø106 / Ø86.



50.263

Oval strop, Ø7. Materiale: EPDM. Længde: 200 mm
Oval strap, Ø7. Material: EPDM. Length: 200 mm



50.243NR

Oval strop. Materiale: NR. Længde: 280 mm
Oval-shaped strap. Material: NR. Length: 280 mm

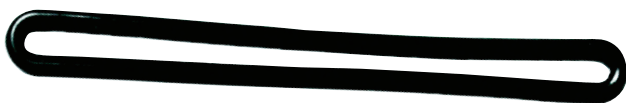

50.267-10

Strop. Materiale: NR. Længde: 400 mm. **Udgår.**
Strap. Material: NR. Length: 400 mm. **Discontinued.**



50.267NR

Strop, oval. Materiale: NR. Længde: 400 mm
Strap oval. Material: NR. Length: 400 mm



50.267

Oval strop. Materiale: EPDM. Længde: 400 mm
Oval strap. Material: EPDM. Length: 400 mm



50.263K

Oval strop med krog. Materiale: EPDM. Længde: 200 mm
Løs krog: 50.263KL
Oval strap with hook. Material: EPDM. Length: 200 mm
Loose hook: 50.263KL



50.263K-10

Oval strop med krog. Materiale: NR. Længde: 204 mm
Udgår (erstattes på sigt af 50.263KNR)
Løs krog: 50.263KL
Oval strap with hook. Material: NR. Length: 204 mm
Discontinued (to be replaced by 50.263KNR)
Loose hook: 50.263KL



Bagagerem *Luggage strap*

50.13621

50.280



Campingstrop med krog / øje.
20 x 490 mm.
Camping strap with hook / eye.
 20 x 490 mm.

Gummistrop til f.eks. transportbure.
Total længde: 610 mm
Længde strop: 480 mm
Rubber strap for e.g. transport boxes.
 Total length: 610 mm
 Length strap: 480 mm

Varenr. <i>Item no.</i>	Mål <i>Measure</i>
79.051	600 mm
79.051A *	700 mm
79.052	900 mm
79.053	1.250 mm
79.054	1.750 mm
79.054A *	2.800 mm
79.055 *	3.000 mm
79.056 *	6.000 mm



Bumper

Bumpers

Bumpers er en enkel løsning til at beskytte personer og materiel.

Bumpers are a simple solution to protect people and equipment.



39.BUMPER

Type A. Sort og gul.
1.000 mm lang.
Selvklæbende.
Type A. Black and yellow.
1.000 mm long.
Adhesive.

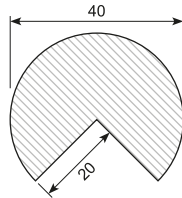

39.BUMPERB

Type B. Sort og gul.
1.000 mm lang.
Selvklæbende.
Type B. Black and yellow.
1.000 mm long.
Adhesive.

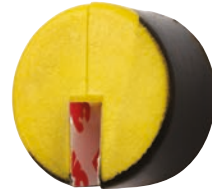
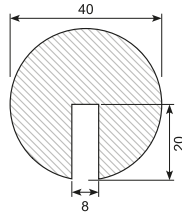

39.BUMPERC

Type C. Sort og gul.
1.000 mm lang.
Selvklæbende.
Type C. Black and yellow.
1.000 mm long.
Adhesive.

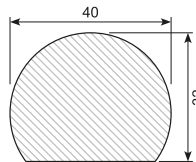

39.BUMPERD

Type D. Sort og gul.
1.000 mm lang.
Selvklæbende.
Type D. Black and yellow.
1.000 mm long.
Adhesive.

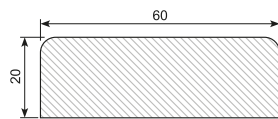

52.PPCC720



*

Orange trafikkegle, 690 mm. Sammenklæpelig.
Ekskl. topblink 52.PPTLRED.
Orange traffic cone, 690 mm. Foldable.
Excl. top blink 52.PPTLRED.

52.PPTLRED



*

Rød advarselsblink for trafikkegle 52.PPCC720
Red warning light for traffic cone 52.PPCC720

* Skaffevare Special order item

Poliall

Poliall

Poliall hængsler er vandtætte stanghængsler, der bl.a. bruges som dørhængsler, foldedørsopbygninger og som hængsel til tophængte låger.

Poliall hinges are waaterproof continuous hinges that are used as door hinges, folding door constructions and as a hinge for top-hung doors.



Centraflex

Vandtæt stanghængsel med polyester-kerne og PVC-flanger. Tillader 165° / 180° åbning. Stor styrke og høj elasticitet. Sort finish.

Water-proof continuous hinge with polyester-core and synthetic flanges. 165° / 180° opening. High strength and excellent flexibility. Black finish.

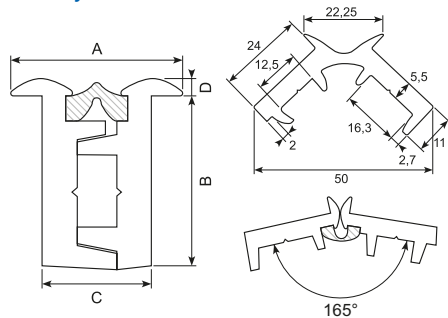

Varenr. Item no.	A	B	C	D	L
20.6020 *	28 mm	23 mm	16 mm	4 mm	2.000 mm
20.6025	28 mm	23 mm	16 mm	4 mm	2.500 mm
20.6030	28 mm	23 mm	16 mm	4 mm	3.000 mm

Poliall

Vandtæt poliall stanghængsel. Med PU kerne og aluminiumsflanger. Tillader 180° åbning.

Forboret med 5 mm huller i flange.

Waterproof poliall continuous hinge. PU core and aluminium flanges. Predrilled with 5 mm holes in flange. Can open 180°.

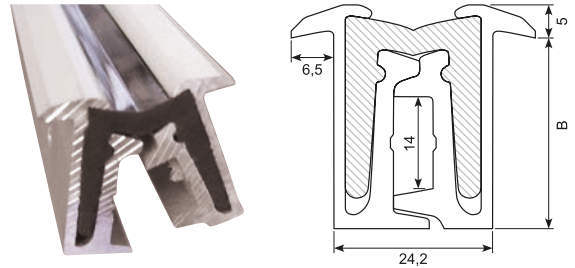

Varenr. Item no.	B	Længde Length
54.261100 *	24 mm	2.400 mm
54.261120 *	24 mm	2.700 mm
54.261130 *	24 mm	4.000 mm

Centraflex

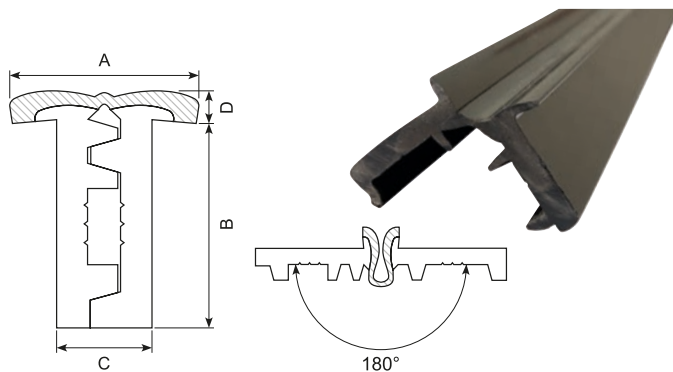

Varenr. Item no.	A	B	C	D	L
20.6120 *	30 mm	34 mm	16 mm	4,5 mm	2.000 mm
20.6125 *	30 mm	34 mm	16 mm	4,5 mm	2.500 mm
20.6130 *	30 mm	34 mm	16 mm	4,5 mm	3.000 mm

Poliall

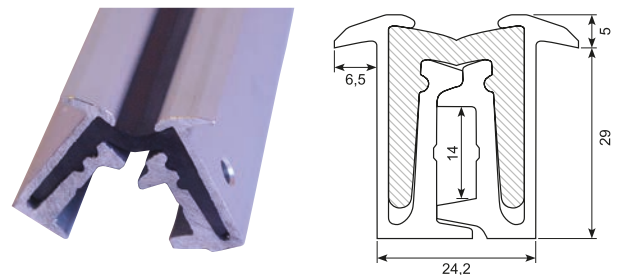

Varenr. Item no.	B	L
54.261700J-5	29 mm	2.400 mm
54.261720J-5	29 mm	2.700 mm
54.261740J-5	29 mm	3.000 mm
54.261760J-5	29 mm	3.200 mm
54.261780J-5	29 mm	4.000 mm

Fleksibel hængsel Flexible hinge

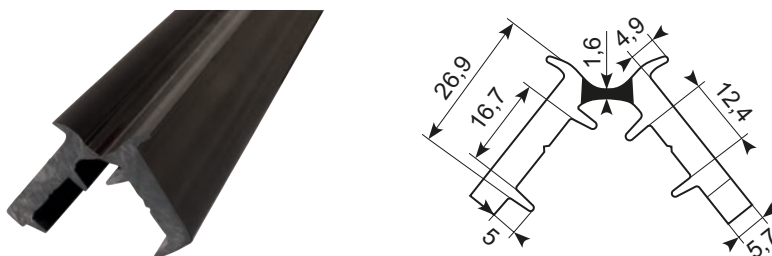

Varenr. Item no.	A	B	C	D	L
20.6019J ● *	26,5 mm	25 mm	16,7 mm	2,5 mm	1.678 mm
20.6020J	26,5 mm	25 mm	16,7 mm	2,5 mm	2.000 mm
20.6025J *	26,5 mm	25 mm	16,7 mm	2,5 mm	2.500 mm
20.6030J *	26,5 mm	25 mm	16,7 mm	2,5 mm	3.000 mm

* Skaffevare: Min. 1.000 stk. Special order item: min. 1.000 pcs.

● Speciallængde med huller Special length with holes



* Skaffevare Special order item

Oppustelige tætninger

Inflatable seals

Oppustelige tætninger aktiveres med trykluft. Disse tætninger slutter helt tæ, og de er derfor egnet til mange slags opgaver. Vores oppustelige tætninger kan evt. leveres med ventil monteret.

Inflatable seals are activated with compressed air. They have a unique ability to close completely tight and are therefore the ideal solution for numerous purposes. It is possible to get our inflatable seals with mounted valve.



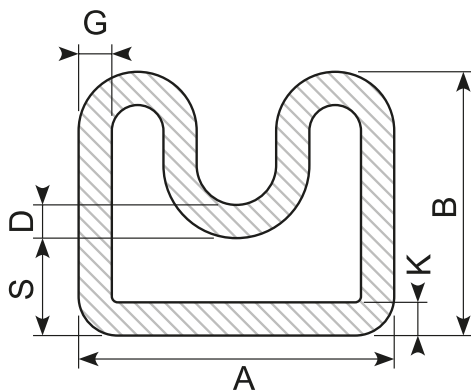
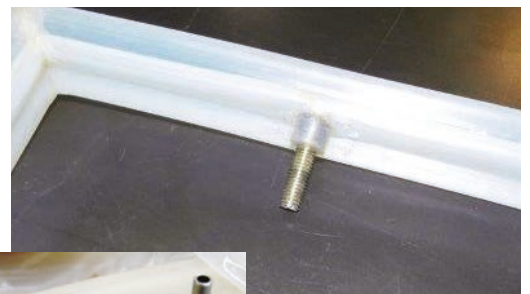
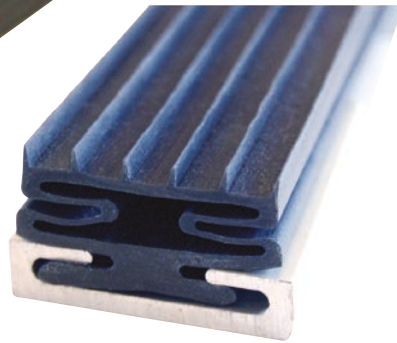
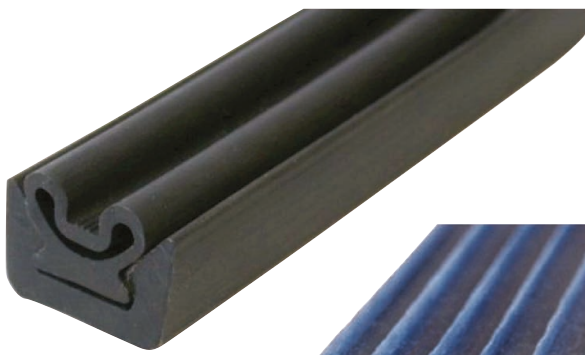

Varenr. <i>Item no.</i>	A mm	B mm	D mm	G mm	K mm	S mm	Materiale <i>Material</i>	Hårdhed <i>Hardness</i>
30.0192-11800 *	10	10	1,5	2	2	5	Silicone	SH 60
30.0192-2819 *	16	14	1,8	1,8	1,8	4,9	Silicone	SH 65
30.0192-4756 *	16	17	1,5	1,5	1,5	10	Silicone	SH 60
30.0192-10963 *	17	14	2	2	2	5	Silicone	SH 60
30.0192-3375 *	18	15,5	2	2	2	2	Silicone	SH 60
30.0192-3161 *	18	15,5	2	2	2	6	Silicone	SH 60
30.0192-4588 *	18,5	17	2	2	2	9	Silicone	SH 60
30.0192-4733 *	18,7	18/16,6	2	2	2	7,9	Silicone	SH 60
30.0192-12642 *	21	15	2	2	2	8	Silicone	SH 60
30.0192-4947 *	22	16	3	3	3	6	Silicone	SH 60
30.0192-3877 *	24	20	2,5	2,5	2,5	5	Silicone	SH 60
30.0192-10680 *	25,3	20	2,7	2,7	2,7	7,3	Silicone	SH 60
30.0192-4633 *	26	20	3	3	3	8,2	Silicone	SH 60
30.0192-11007 *	26	20	3	3	3	8,5	Silicone	SH 60
30.0192-10927 *	26,5	20	3	3	3	9	Silicone	SH 60
30.0192-4926 *	27	20	4	4	4	10	Silicone	SH 60
30.0192-10322 *	30	15	3	3	3	3,7	Silicone	SH 60
30.0192-4634 *	35	32	5	5	5	17,6	Silicone	SH 60
30.0192-11484 *	35	34	3	3	3	17	Silicone	SH 60
30.0192-12418 *	45	34	3	3	5	9	Silicone	SH 60
30.0192-11016 *	46	34	3	3	5	9	Silicone	SH 60

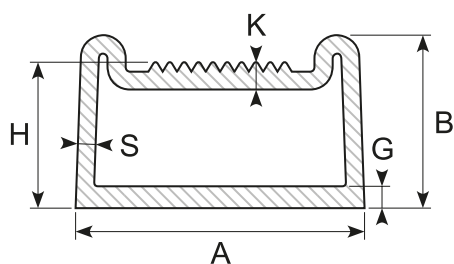

Varenr. <i>Item no.</i>	A mm	B mm	D mm	G mm	K mm	S mm	Materiale <i>Material</i>	Hårdhed <i>Hardness</i>
30.0192-3414 *	8,6	8,3	1,2	7,5	1,4	1,2	Silicone	SH 60
30.0192-4906 *	12	8	1,2	6,3	1,5	1,2	Silicone	SH 60
30.0192-3415 *	12	8,5	1,2	7,7	1,4	1,2	Silicone	SH 60
30.0192-4792 *	16	7,5	1,2	7	1,5	1	Silicone	SH 60
30.0192-3214 *	16	9,5	1,2	8	1,5	1	Silicone	SH 76
30.0192-2076 *	16	10	2	10	2,5	1	Silicone	SH 50
30.0192-11527 *	17	8,5	1,2	7	1,5	1	Silicone	SH 60
30.0192-3739 *	17	8,5	1,5	7	2	1	Silicone	SH 76
30.0192-2969 *	17	9,5	1,2	8	1,5	1	Silicone	SH 76
30.0192-10966 *	30	30,3	4	33,5	9,9	4	Silicone	SH 60

* Skaffevare Special order item

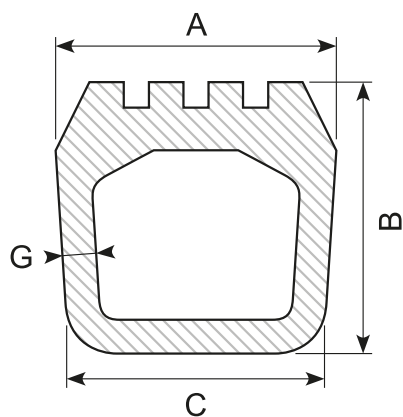

Varenr. <i>Item no.</i>	A mm	B mm	C mm	G mm	Hårdhed <i>Hardness</i>
30.0192-11093 *	13,6	10	13,6	2	SH 55
30.0192-12442 *	14	10	14	1,7	SH 50
30.0192-11137 *	14	14	14	3	SH 60
30.0192-4973 *	15,2	13,6	16,2	2	SH 55
30.0192-10389 *	16	12	16	2	SH 60
30.0192-10519 *	16	12	16	2	SH 60
30.0192-10142 *	16	12	16	2,5	SH 60
30.0192-11278 *	17	9	17	2	SH 55
30.0192-10358 *	21	24	21	3	SH 60
30.0192-11937 *	22	20	22	3	SH 60
30.0192-11342 *	32,5	32	35	5	SH 60
30.0192-11385 *	33,5	30	35	5	SH 60
30.0192-11991 *	33,7	32	33,7	5	SH 60
30.0192-4626 *	34	25	34	5	SH 60
30.0192-11550 *	34	35	35	5	SH 70
30.0192-10318 *	35	31	35	4,5	SH 65
30.0192-12300 *	35	31,5	35	5	SH 60
30.0192-3900 *	35	32	35	5	SH 60
30.0192-4690 *	35	32	35	4,5	SH 60
30.0192-10947 *	35	32	35	3,3	SH 55
30.0192-12465 *	35	33	35	4	SH 60
30.0192-12398 *	35	35	35	4,3	SH 60

Varenr. <i>Item no.</i>	A mm	B mm	C mm	G mm	Hårdhed <i>Hardness</i>
30.0192-3365 *	14	10	14	2	SH 60
30.0192-2845 *	14	11	13	2	SH 60
30.0192-1494 *	14	11	14	2/2,25	SH 60
30.0192-2029 *	14	14	15,5	2,5	SH 50
30.0192-3616 *	15,5	18	15,5	2	SH 60
30.0192-3588 *	16	14	16	2	SH 60
30.0192-1345 *	16	18	16	2,5	SH 50
30.0192-0374 *	16	20	15	2,5	SH 50
30.0192-2408 *	16,5	13	16,5	2,5	SH 55
30.0192-2067 *	16,5	16	15	2	SH 55
30.0192-0459 *	17	18	15	2,5	SH 50
30.0192-0460 *	17	18	17	3,5	SH 50
30.0192-1949 *	17,5	20	17,5	3	SH 45
30.0192-1768 *	27	19	27	3,5	SH 50
30.0192-3497 *	27,5	25	27,5	3	SH 60
30.0192-3551 *	33,5	32	35	5	SH 60
30.0192-0431 *	34	35	35	5	SH 60
30.0192-3845 *	35	32	35	4	SH 60
30.0192-2364 *	35	32	35	5	SH 60
30.0192-1744 *	35	33	35	5,5	SH 55
30.0192-1881 *	36	26,9	36	5	SH 55
30.0192-3693 *	53	41,5	53	5	SH 60

Ventil eksempel *Valve example*

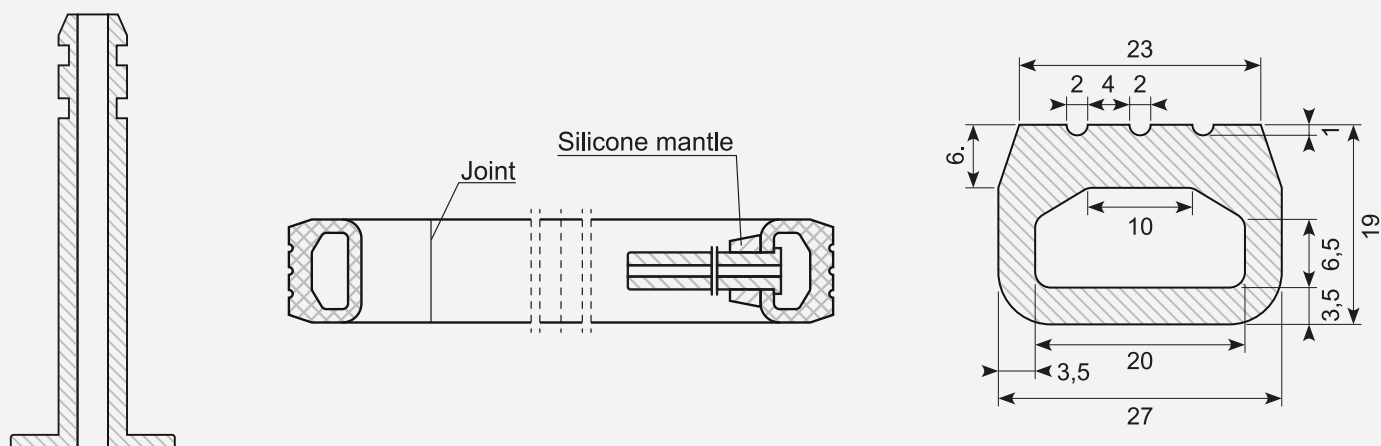

84.930



Rudeværktøjssæt med værktøj til låseliste, Ø9,5 mm trådøje og monteringsjern.

Window tool set with tool for locking strip, Ø9.5 mm wire eye and mounting iron.

84.931



Værktøj til låseprofiler, aluminium. Inkl. Ø9,5 mm trådøje.

Tool for locking profiles, aluminum. Incl. Ø9,5 mm wire eye.

84.932T



Monterings-jern til rudelister
Mounting bracket for glazing sections

84.935



Løst trådøje til 84.931, Ø10,5 mm.

Loose wire eye for 84.931, Ø10,5 mm.

84.934A



Løst trådøje til 84.931, Ø6 mm.

Loose wire eye for 84.931, Ø6 mm.

84.934



Løst trådøje til 84.931, Ø9,5 mm.

Loose wire eye for 84.931, Ø9,5 mm.

30.shoreA



Shore A hårdhedsmåler
Shore A hardness tester

30.shoreD



Shore D hårdhedsmåler
Shore D hardness tester

30.shore20-90



Shore tester, silikonegummi
Shore samples, silicone rubber.

87.770/10



Primer loctite SF 770 - forbedrer klæbeevnen på materialer, der er svære at lime.

Primer loctite SF 770 - improves adhesion on difficult to bond materials.

87.1034



Sekundlim Permalock, 3 g. Velegnet til EPDM

Super glue Permalock, 3 g. Suitable for EPDM

87.1035



Sicomet Sekundlim, 20 gr. Velegnet til svampegummi

Sicomet super glue, 20 gr. Suitable for sponge rubber.

87.2010



SikaFast 2590 - en hurtighærdende og spalteudfyldende tokomponent universal lim", 10 ml.

A fast curing and gap-filling two-component Universal Glue

87.723



Spraylim, Loctite 9323

Spray glue. Loctite 3923.

87.7051



TeroKAL 2444, 340 g. CR-klæbestof til limning af bl.a. svampegummi, lyd-dæmpningsmaterialer m.m.

TeroKAL 2444, 340 g. CR adhesive for bonding sponge rubber, soundproofing materials, etc.

87.52759 / 87.52759X



Terostat 2759, 310 ml, grå. Enkomponent tætningsstof til tætning mellem gummi og metal.

Terostat 2759, 310 ml, grey. One-component sealant for sealing between rubber and metal.

87.52759X: Foliepose Foil bag, 570 ml

87.51989 / 87.51999F



Terostat 930, 310 ml, sort. Elastisk og stærk tætningsmasse for metal, glas og gummi.

Terostat 930, 310 ml, black. Elastic and strong sealant for metal, glass and rubber.

87.51999F: Foliepose Foil bag, 570 ml

87.51939S



Teroson MS 939, 290 ml, sort. Til elastisk limning med høj styrke, som absorberer vibrationer.

Teroson MS 939, 290 ml, black. For high-strength elastic bonding that absorbs vibrations.

Min order: 12 pcs.

Butylbånd

Varenr. <i>Item no.</i>	Beskrivelse <i>Description</i>
87.81152	Terostat 81 - 15 x 2 mm, 30 m
87.812015	Terostat 81 - 20 x 1,5 mm, 40 m
87.81252	Teroson RB 81 - 25 x 2 mm, 35 m
87.81302	Terostat 81 - 30 x 2,0 mm, 30 m
87.814015	Terostat 81 - 40 x 1,5 mm, 40 m



* Skaffevare *Special order item*

Egenskaber gummityper NR, SBR, NBR, CR og EPDM

Properties rubber types NR, SBR, NBR, CR and EPDM

Navnefortegnelse i.h.t. ASTM D 1418 <i>Abbreviation as per ASTM D 1418</i>	NR	SBR	NBR	CR	EPDM
Kemisk betegnelse <i>Chemical nomenclature</i>	Natur-kautsjuk <i>Natural rubber</i>	Styrolbutadien kautsjuk <i>Styrol butadien rubber (Buna)</i>	Nitril kautsjuk (Perbunan) <i>Nitril rubber (Perbunan)</i>	Chlororen kautsjuk (Neopren) <i>Chloroprene rubber (Neoprene)</i>	Ethylen propylen kautsjuk (APTK) <i>Ethylene propylene dien rubber</i>
Hårdhedsområde (Shore A)(±5) <i>Hardness range (Shore A)(±5)</i>	40 - 90	45 - 90	45 - 90	40 - 90	40 - 90
Trækstyrke N/mm² <i>Tensile strength N/mm²</i>	4 - 15	4 - 15	4 - 14	5 - 15	6 - 13
Tilbagestødselasticitet ved 20°C <i>Recoil elasticity at 20°C</i>	Udmærket <i>Excellent</i>	God <i>Good</i>	Tilfredsstillende <i>Satisfactory</i>	God <i>Good</i>	God <i>Good</i>
Slidstyrke <i>Abrasion resistance</i>	Meget god <i>Very good</i>	Meget god <i>Very good</i>	God <i>Good</i>	God <i>Good</i>	God <i>Good</i>
(1) Kemisk bestandighed <i>Chemical resistance</i>	God <i>Good</i>	God <i>Good</i>	Tilfredsstillende <i>Satisfactory</i>	God <i>Good</i>	Meget god <i>Very good</i>
(1) Oliebestandighed <i>Oil resistance</i>	Ringe <i>Low</i>	Ringe <i>Low</i>	Udmærket <i>Excellent</i>	God <i>Good</i>	Ringe <i>Low</i>
(1) Bestandighed overfor benzin <i>Petrol resistance</i>	Ingen <i>None</i>	Ringe <i>Low</i>	God <i>Good</i>	Ringe <i>Low</i>	Ringe <i>Low</i>
(1) Bestandighed overfor opløsningsmidler <i>Solvent resistance</i>	Ringe <i>Low</i>	Ringe <i>Low</i>	God <i>Good</i>	God <i>Good</i>	(3) Tilfredsstillende <i>Satisfactory</i>
(4) Temperaturbestandighed °C <i>Temperature resistance °C</i>	-40 / +80°C	-30 / +80°C	-30 / +100°C	-25 / +100°C	-40 / +100°C
Ozonbestandighed <i>Ozone resistance</i>	Tilfredsstillende <i>Satisfactory</i>	Tilfredsstillende <i>Satisfactory</i>	Tilfredsstillende <i>Satisfactory</i>	Meget god <i>Very good</i>	Udmærket <i>Excellent</i>
Vejrbestandighed <i>Weather resistance</i>	God <i>Good</i>	God <i>Good</i>	God <i>Good</i>	Meget god <i>Very good</i>	Udmærket <i>Excellent</i>
Gasuigennemtrængelighed <i>Gas impermeability</i>	Tilfredsstillende <i>Satisfactory</i>	Tilfredsstillende <i>Satisfactory</i>	God <i>Good</i>	God <i>Good</i>	Tilfredsstillende <i>Satisfactory</i>
(2) Modstand mod blivende deformation <i>Resistance to permanent deformation</i>	Meget god <i>Very good</i>	God <i>Good</i>	God <i>Good</i>	God <i>Good</i>	God <i>Good</i>
Bindekraft til metal <i>Adhesion to metal</i>	Udmærket <i>Excellent</i>	Meget god <i>Very good</i>	Tilfredsstillende <i>Satisfactory</i>	God <i>Good</i>	Tilfredsstillende <i>Satisfactory</i>
Bindekraft til tekstiler <i>Adhesion to textile</i>	Udmærket <i>Excellent</i>	God <i>Good</i>	Tilfredsstillende <i>Satisfactory</i>	Udmærket <i>Excellent</i>	Tilfredsstillende <i>Satisfactory</i>

Egenskaber plasttyper POM og PVC

Properties plastic types POM and PVC

Navnefortegnelse <i>Abbreviation</i>	POM	PVC
Kemisk betegnelse <i>Chemical nomenclature</i>	Polyoxymethylene	Polyvinylchlorid
(1) Kemisk bestandighed <i>Chemical resistance</i>	God <i>Good</i>	God <i>Good</i>
(1) Oliebestandighed <i>Oil resistance</i>	Meget god <i>Very good</i>	God <i>Good</i>
(1) Bestandighed overfor benzin <i>Petrol resistance</i>	Meget god <i>Very good</i>	Ingen <i>None</i>
Ozonbestandighed <i>Ozone resistance</i>	Ingen <i>None</i>	Meget god <i>Very good</i>
Svovlsyre bestandighed <i>Sulfuric acid resistance</i>	Ingen <i>None</i>	Ingen <i>None</i>
(4) Temperaturbestandighed °C <i>Temperature resistance °C</i>	Ca. -40 / +100°C	Ca. -10 / +60°C
Egenskaber <i>Properties</i>	Gode mekaniske egenskaber, slidbestandig, dimensionsstabil <i>Good mechanical properties, abrasion resistant, dimensionally stable</i>	God mekanisk vurdering, god svejse/vedhæft egenskaber, bliver hårdere i benzin og olie <i>Good mechanical rating, good welding/adhesion properties, hardens in petrol and oil</i>

Egenskaber plasttype TPE

Properties plastic type TPE

Type og kvalitet <i>Type and quality</i>	TPE (gennemsigtig) <i>TPE (transparent)</i>	TPE (normal)
Kemisk betegnelse <i>Chemical nomenclature</i>	Termoplastiske elastomerer	
Hårdhed <i>Hardness</i>	55 Sh A - 50 Sh D	60 Sh A - 50 Sh D
Temperaturbestandighed °C <i>Temperature resistance °C</i>	-50 til +125°C	-50 til +125°C
Egenskaber <i>Properties</i>	Fremragende vejrbestandighed. God kemisk bestandighed (undtagen ved organisk opløsningsmiddel, aromatiske- og vegetabiliske olier). <i>Excellent weather resistance. Good chemical resistance (except for organic solvent, aromatic and vegetable oils).</i>	

- På grund af mange mulige kemikalier, opløsningsmidler, arbejdstemperaturer og arbejdstider kan de oplyste værdier i enkelte tilfælde udvise forandringer. Især kan en elastomertype, som normalt udviser ringe bestandighed, udvise en meget god resistens overfor bestemte medier.
In view of the multitude of chemicals, solvents, application temperatures and times, the value quoted may vary in some cases. For example one type of elastomer, which normally has only low resistance properties, could show very good resistance to certain media.
- Ved relativt lave hhv. høje temperaturer reduceres modstanden normalt. *At relatively high or low temperatures, resistance generally drops.*
- God udvidelsesbestandighed overfor forskellige blødgørere. *Good expansion resistance to various ester based plasticizers.*
- Det drejer sig om grænseværdier, som kan svinge alt efter sammensætningen af blandingen. Vedvarende indsætning i grænseområderne ændrer de fysiske værdier. Til ekstreme påvirkninger kræves særlige elastomere-blandinger.
These are borderline values which, depending on composition of the mixture, can vary. If used permanently in such borderline areas, this can lead to a change in the physical values. For such extreme applications it is advisable to use special elastomer mixtures.

Egenskaber silikone *Properties silicone*

Egenskaber <i>Properties</i>	
Arbejdstemperatur (standarddele) <i>Working temperature (standard compounds)</i>	-50°C to +180°C / +250°C
Arbejdstemperatur (specialdele) <i>Working temperature (specific compounds)</i>	-90°C / +315°C
Forlængelse <i>Elongation</i>	300 - 800%
Hårdhed <i>Hardness</i>	25 - 80 SHA
Sammenbrudsspænding <i>Breakdown voltage</i>	23 kV (VDE 0303)
Materialer til specifikke applikationer <i>Materials for specific applications</i>	Høj kemikalie resistens. God dæmpning af høj- og lavfrekvent vibrationer. Silikonegummiprodukter er smagløse og lugtfrie. Modstandsdygtig over for aldring og vejrforhold <i>High chemical resistance. Good damping of high and low frequency vibrations. Silicone rubber products are tasteless and odourless. Resistance to ageing and weather conditions.</i>
Farver <i>Colors</i>	Farven på silikoneprodukter kan vælges til en given applikation: Fra gennemsigtig til sort i overensstemmelse med RAL, inklusiv metalfaver (aluminium, stål, messing). Farverne er kendetegnet ved livlighed og holdbarhed. <i>The colour of silicon products can be suitably chosen for the particular application: from transparent to black, in accordance to RAL, including metallic colours (aluminium, steel, brass). The colours feature of vividness and durability</i>

Tolerancer for ekstruderede profiler *Tolerances for extruded profiles*

Dimensionstolerancer for støbte, ekstruderede og kalandrede massive gummiprodukter. (GB/T 3672-92) ISO3302-1998.

Dimensional tolerances for moulded, extruded and calendered solid rubber products. (GB/T 3672-92) ISO3302-1998.

Gummitykkelse <i>Rubber thickness</i>	E1 ±	E2 ± Solid	E3 ± Svampegummi <i>Spongerubber</i>
0 - 1,5 mm	0,15 mm	0,25 mm	0,4 mm
1,5 - 2,5 mm	0,2 mm	0,35 mm	0,5 mm
2,5 - 4 mm	0,25 mm	0,4 mm	0,65 mm
4 - 6,3 mm	0,35 mm	0,5 mm	0,8 mm
6,3 - 10 mm	0,4 mm	0,65 mm	1 mm
10 - 16 mm	0,5 mm	0,8 mm	1,3 mm
16 - 25 mm	0,65 mm	1 mm	1,6 mm
25 - 40 mm	0,8 mm	1,3 mm	2 mm
40 - 63 mm	1 mm	1,6 mm	2,5 mm
63 - 100 mm	1,3 mm	2 mm	3,2 mm

Længdetolerancer for afkortede profiler *Length tolerances for shortened profiles*

Længdetolerancer for massive gummiprofiler DIN 7715-L2

Solid rubber profile length tolerances DIN 7715-L2

Nominelt område <i>Nominal range</i>				± mm
Fra <i>From</i>	0 mm	Til <i>To</i>	40 mm	1,0
Over	40 mm	Til <i>To</i>	63 mm	1,3
Over	63 mm	Til <i>To</i>	100 mm	1,6
Over	100 mm	Til <i>To</i>	160 mm	2,0
Over	160 mm	Til <i>To</i>	250 mm	2,5
Over	250 mm	Til <i>To</i>	400 mm	3,2
Over	400 mm	Til <i>To</i>	360 mm	4,0
Over	630 mm	Til <i>To</i>	1.000 mm	5,0
Over	1.000 mm	Til <i>To</i>	1.600 mm	6,3
Over	1.600 mm	Til <i>To</i>	2.500 mm	10,0
Over	2.500 mm	Til <i>To</i>	4.000 mm	12,5
Over	4.000 mm	Til <i>To</i>		0,32%

Varenummerindeks *Item number index*

20.6019J.....	139	30.0192-3616.....	142	30.108NBR.....	27	30.13186-4.....	90	30.2455.....	50
20.6020.....	139	30.0192-3693.....	142	30.108SIH.....	27	30.13186-5.....	90	30.2505E.....	29
20.6020J.....	139	30.0192-3739.....	141	30.108SIHX.....	27	30.13186-6.....	90	30.2525E.....	29
20.6025.....	139	30.0192-3845.....	142	30.109.5CR.....	27	30.13186-7.....	90	30.2566.....	31
20.6025J.....	139	30.0192-3877.....	141	30.109.5NBR.....	27	30.13186-8.....	90	30.257S.....	32
20.6030.....	139	30.0192-3900.....	142	30.109CR.....	27	30.13242.....	36	30.262S.....	29
20.6030J.....	139	30.0192-4588.....	141	30.109E.....	27	30.13242.....	36	30.2653.....	32
20.6120.....	139	30.0192-4626.....	142	30.109NBR.....	27	30.132CR.....	27	30.2984-1.....	51
20.6125.....	139	30.0192-4633.....	141	30.110CR.....	27	30.132NBR.....	27	30.2984-2.....	51
20.6130.....	139	30.0192-4634.....	141	30.110E.....	27	30.13315.....	70	30.2984-3.....	51
30.0192-0374.....	142	30.0192-4690.....	142	30.110NBR.....	27	30.13421.....	33	30.2984-5.....	51
30.0192-0431.....	142	30.0192-4733.....	141	30.111CR.....	27	30.13447-8.....	34	30.2984-6.....	51
30.0192-0459.....	142	30.0192-4756.....	141	30.111NBR.....	27	30.13503.....	36	30.3003E.....	29
30.0192-0460.....	142	30.0192-4792.....	141	30.112CR.....	27	30.13535.....	50	30.3006E.....	29
30.0192-10142.....	142	30.0192-4906.....	141	30.112E.....	27	30.135E.....	27	30.313.....	32
30.0192-10318.....	142	30.0192-4926.....	141	30.112NBR.....	27	30.135NBR.....	27	30.314S.....	32
30.0192-10322.....	141	30.0192-4947.....	141	30.11393.....	48	30.136.....	54	30.315S.....	32
30.0192-10358.....	142	30.0192-4973.....	142	30.113CR.....	27	30.136/45.....	54	30.315SB.....	33
30.0192-10389.....	142	30.10003K.....	29	30.113E.....	27	30.136NBR.....	54	30.324S.....	31
30.0192-10519.....	142	30.10005E.....	29	30.113NBR.....	27	30.13708.....	54	30.324SB.....	31
30.0192-10680.....	141	30.10036.....	36	30.11459.....	49	30.13841.....	33	30.325X.....	31
30.0192-10927.....	141	30.101.....	27	30.114CR.....	27	30.1386.....	50	30.3305E.....	29
30.0192-10947.....	142	30.101.25.....	27	30.114E.....	27	30.138NBR.....	54	30.331.....	30
30.0192-10963.....	141	30.101.5.....	27	30.114NBR.....	27	30.138S.....	54	30.3310E.....	29
30.0192-10966.....	141	30.102.....	27	30.115CR.....	27	30.140.....	54	30.333X.....	30
30.0192-11007.....	141	30.102E.....	27	30.115E.....	27	30.14053.....	33	30.340.....	34
30.0192-11016.....	141	30.102NBR.....	27	30.116CR.....	27	30.14098-2.....	31	30.4003E.....	29
30.0192-11093.....	142	30.103.5CR.....	27	30.116E.....	27	30.140CR.....	27	30.4437.....	35
30.0192-11137.....	142	30.103.5NBR.....	27	30.116NBR.....	27	30.140NBR.....	27	30.4469.....	35
30.0192-11278.....	142	30.103CR.....	27	30.11774.....	50	30.141.....	34	30.5003E.....	29
30.0192-11342.....	142	30.103E.....	27	30.117E.....	27	30.14130.....	33	30.5003K.....	29
30.0192-11385.....	142	30.103EX.....	27	30.118CR.....	27	30.14163.....	34	30.5004E.....	29
30.0192-11484.....	141	30.103NBR.....	27	30.118E.....	27	30.14163-1.....	34	30.5005E.....	29
30.0192-11527.....	141	30.103SIH.....	27	30.118NBR.....	27	30.14226.....	30	30.5010E.....	29
30.0192-11550.....	142	30.104.5CR.....	27	30.11911.....	51	30.14227.....	51	30.50967.....	33
30.0192-11800.....	141	30.104.5E.....	27	30.119E.....	27	30.1428.....	33	30.5179.....	34
30.0192-11937.....	142	30.104.5NBR.....	27	30.1201KE.....	29	30.142S.....	34	30.5550M.....	32
30.0192-11991.....	142	30.10461-2.....	36	30.120CR.....	27	30.14356.....	51	30.5808E.....	29
30.0192-12300.....	142	30.10485.....	35	30.120E.....	27	30.144.....	34	30.5881.....	31
30.0192-12398.....	142	30.104CR.....	27	30.120NBR.....	27	30.145.....	34	30.5981.....	32
30.0192-12418.....	141	30.104E.....	27	30.121E.....	27	30.14507-1.....	49	30.6487.....	55
30.0192-12442.....	142	30.104NBR.....	27	30.122CR.....	27	30.14507-2.....	49	30.6502.5E.....	29
30.0192-12465.....	142	30.104SIH.....	27	30.122E.....	27	30.14507-3.....	51	30.6622.....	49
30.0192-12642.....	141	30.105.3CR.....	27	30.122NBR.....	27	30.14803.....	109	30.6622N.....	49
30.0192-1345.....	142	30.105.3NBR.....	27	30.124E.....	27	30.148S.....	54	30.6648.....	31
30.0192-1494.....	142	30.105.7CR.....	27	30.125CR.....	27	30.15005E.....	29	30.6648G.....	31
30.0192-1744.....	142	30.105.7NBR.....	27	30.125E.....	27	30.15005KE.....	29	30.6648S.....	31
30.0192-1768.....	142	30.105CR.....	27	30.125NBR.....	27	30.150CR.....	27	30.6648S.....	31
30.0192-1881.....	142	30.105E.....	27	30.12759.....	29	30.15170.....	33	30.6705E.....	29
30.0192-1949.....	142	30.105NBR.....	27	30.12896.....	50	30.16239.....	36	30.6710E.....	29
30.0192-2029.....	142	30.105SIH.....	27	30.12932-1.....	50	30.16688.....	35	30.6724.....	49
30.0192-2067.....	142	30.106.5CR.....	27	30.12932-2.....	35	30.176.....	55	30.6944.....	32
30.0192-2076.....	141	30.106.5NBR.....	27	30.12957-1.....	30	30.180.....	55	30.7106.....	32
30.0192-2364.....	142	30.106CR.....	27	30.12957-2.....	30	30.182.....	54	30.7266.....	35
30.0192-2408.....	142	30.106E.....	27	30.12957-3.....	31	30.190.....	33	30.7300.....	32
30.0192-2819.....	141	30.106NBR.....	27	30.13049-1.....	35	30.2005E.....	29	30.7300/4.....	32
30.0192-2845.....	142	30.106SIH.....	27	30.13049-2.....	35	30.211.04.385.....	52	30.7300/4Y.....	32
30.0192-2969.....	141	30.107.5CR.....	27	30.13049-4.....	35	30.21101205.....	51	30.7367.....	29
30.0192-3161.....	141	30.107.5NBR.....	27	30.13049-5.....	35	30.21202300.....	35	30.7408X.....	54
30.0192-3214.....	141	30.10777-1.....	50	30.13066.....	109	30.2151.....	31	30.7411.....	35
30.0192-3365.....	142	30.107CR.....	27	30.13086.....	49	30.2151S.....	31	30.7505E.....	29
30.0192-3375.....	141	30.107E.....	27	30.130CR.....	27	30.216S.....	29	30.7508.....	50
30.0192-3414.....	141	30.107NBR.....	27	30.130NBR.....	27	30.218S.....	30	30.7509.....	50
30.0192-3415.....	141	30.108.4CR.....	27	30.13144XX.....	70	30.220L.....	30	30.7519.....	51
30.0192-3497.....	142	30.108.4NBR.....	27	30.13186-1.....	90	30.22381.....	54	30.7519NBR.....	51
30.0192-3551.....	142	30.108CR.....	27	30.13186-2.....	90	30.2310E.....	29	30.7559.....	33
30.0192-3588.....	142	30.108E.....	27	30.13186-3.....	90	30.2438.....	34	30.762.....	35

30.7645.....	33	31.025S.....	48	32.514S.....	58	33.310X.....	5	33.401G.....	5
30.7648.....	32	31.035S.....	52	32.516S.....	58	33.311.....	19	33.403F.....	11
30.7649.....	31	31.036SI.....	52	32.523S.....	58	33.312.....	19	33.407A.....	11
30.7649-12.....	31	31.036SI-LTC.....	52	32.527.....	58	33.319.....	12	33.408A.....	11
30.7649-8.....	31	31.037.....	52	32.7125.....	59	33.319F.....	12	33.408B.....	11
30.7650.....	31	31.037SI.....	51	32.7195S.....	59	33.321.....	13	33.408X.....	11
30.7651.....	32	31.038SI.....	52	32.754S.....	58	33.323.....	12	33.409.....	5
30.7652.....	30	31.041S.....	48	32.795S.....	59	33.324CR.....	12	33.409ALU.....	17
30.7663.....	34	31.042S.....	48	32.8517.....	34	33.326.....	14	33.409F.....	5
30.7696.....	29	31.043S.....	49	32.8518.....	33	33.331.....	14	33.409POM.....	24
30.7780/4.....	32	31.047.....	48	32.8520.....	34	33.332B.....	14	33.409POMX.....	24
30.7932.....	30	31.048.....	51	32.866.....	59	33.332X.....	13	33.410POMX.....	24
30.7933.....	30	31.050.....	51	32.924.....	57	33.335.....	13	33.410X.....	5
30.7935.....	30	31.060S.....	48	32.924K.....	57	33.338F.....	12	33.410XG.....	5
30.798.....	34	31.061S.....	49	32.924K.....	61	33.339X.....	13	33.411.....	6
30.7987.....	50	31.063.....	48	33.000.....	17	33.340.....	14	33.414.....	6
30.8199.....	32	31.064.....	49	33.019.....	14	33.351.....	9	33.415.....	6
30.8199W.....	32	31.065S.....	49	33.020.....	13	33.351A.....	9	33.416.....	109
30.8331.....	34	31.066.....	49	33.020NBR.....	13	33.352.....	9	33.417TPE.....	25
30.8439.....	57	31.068S.....	49	33.021.....	8	33.353.....	9	33.417TPEX.....	25
30.8469.....	30	31.070S.....	50	33.022.....	14	33.353NBR.....	9	33.418SS.....	5
30.8538.....	55	31.071S.....	50	33.024.....	13	33.353X.....	9	33.418X.....	6
30.8538B.....	55	31.074S.....	50	33.025.....	10	33.354.....	8	33.419.....	6
30.9215.....	36	31.112S.....	59	33.026.....	16	33.354A.....	8	33.419A.....	6
30.9387-1.....	36	31.116S.....	59	33.026X.....	17	33.354B.....	8	33.420FX.....	6
30.9387-2.....	35	31.145S.....	59	33.026XA.....	16	33.355B.....	11	33.420H.....	6
30.9437-125.....	36	31.148.....	59	33.094X.....	6	33.357X.....	9	33.420X.....	5
30.9437-160.....	37	31.155.....	59	33.1153A.....	6	33.358A.....	8	33.422.....	5
30.9437-200.....	37	31.216GS.....	49	33.1153GA.....	6	33.358B.....	8	33.424.....	25
30.9437-250.....	37	31.216ST.....	49	33.1154.....	7	33.358D.....	8	33.424TPE.....	25
30.9437-315.....	37	31.365.....	59	33.1155.....	7	33.358E.....	8	33.424TPEX.....	25
30.9437-400.....	37	31.369.....	34	33.1156.....	7	33.358X.....	8	33.426.....	7
30.9519.....	50	31.4281.....	83	33.1157.....	7	33.359X.....	9	33.426A.....	6
30.9548.....	48	31.6701.....	59	33.1158A.....	7	33.360.....	10	33.426GA.....	6
30.9691-3.....	31	31.6702.....	59	33.1159.....	7	33.360F.....	10	33.426X.....	7
30.9691-5500.....	29	31.6703.....	59	33.1160.....	7	33.360NBR.....	10	33.426XA.....	6
30.9826-1.....	36	31.702.....	35	33.1161.....	7	33.360R.....	10	33.427X.....	6
30.9826-2.....	36	31.OT2179.....	55	33.1162.....	7	33.360X.....	10	33.428.....	7
30.9884S.....	70	32.009S.....	61	33.1163.....	7	33.362.....	10	33.428G.....	7
30.9884X.....	52	32.016S.....	57	33.12116.....	14	33.362C.....	10	33.429.....	19
30.9885.....	52	32.034S.....	57	33.200POM.....	24	33.362D.....	10	33.430.....	7
30.9996-10.....	30	32.036S.....	57	33.200POMX.....	24	33.362E.....	10	33.430A.....	7
30.9996-4.....	36	32.036X.....	57	33.201POM.....	24	33.362F.....	10	33.431A.....	20
30.9996-5.....	36	32.044S.....	57	33.203POM.....	24	33.362FX.....	9	33.432.....	5
30.E368.....	70	32.046S.....	57	33.203POMX.....	24	33.362X.....	10	33.432ALU.....	17
30.OT0136.....	50	32.047.....	57	33.210POM.....	24	33.365X.....	10	33.433.....	7
30.OT101.....	54	32.057.....	58	33.210POMX.....	24	33.367.....	10	33.434.....	6
30.OT1024.....	29	32.064S.....	58	33.211POM.....	24	33.367X.....	11	33.435X.....	6
30.OT1024B.....	29	32.066.....	58	33.212POM.....	24	33.369.....	9	33.436.....	17
30.OT1057.....	54	32.075.....	58	33.213POMX2.....	24	33.370NBR.....	9	33.438.....	5
30.OT10644.....	33	32.095S.....	58	33.214POM.....	24	33.371E.....	8	33.439A.....	16
30.OT1080.....	55	32.1024S.....	57	33.215POM.....	24	33.371FX.....	8	33.442.....	17
30.OT1081.....	55	32.1025S.....	57	33.216POM.....	25	33.371X.....	9	33.443X.....	16
30.OT1387.....	33	32.1025SK.....	57	33.217POM.....	25	33.372X.....	12	33.444A.....	12
30.OT2036.....	54	32.1037S.....	58	33.218POM.....	25	33.374.....	10	33.444X.....	12
30.OT3271.....	55	32.1045S.....	58	33.220POM.....	24	33.375.....	11	33.449.....	13
30.OT3272.....	33	32.1045SK.....	57	33.221POM.....	24	33.376.....	9	33.450NBR.....	12
30.OT3334.....	55	32.1301.....	61	33.306.....	5	33.377.....	10	33.451E.....	13
30.OT3354.....	33	32.1307S.....	59	33.307.....	5	33.378.....	11	33.452R.....	13
30.OT3394.....	48	32.1640.....	58	33.307A.....	5	33.379.....	11	33.452X.....	14
30.OT3440.....	50	32.165.....	58	33.308.....	5	33.380.....	11	33.453X.....	14
30.shore20-90.....	144	32.2024CR.....	57	33.308A.....	5	33.381.....	12	33.454X.....	13
30.shoreA.....	144	32.2024M.....	57	33.308POM.....	24	33.382.....	15	33.455.....	14
30.shoreD.....	144	32.2045M.....	57	33.308POMG.....	24	33.383.....	16	33.456F.....	14
30.SM251.....	55	32.255S.....	58	33.308POMXG.....	24	33.395F.....	12	33.457.....	12
30.WI660.....	29	32.300X.....	61	33.309XM.....	5	33.395X.....	11	33.457S-4.....	13
31.018S.....	48	32.301X.....	61	33.310ALU.....	17	33.395XA.....	11	33.457S-5.....	13
31.018X.....	48	32.309X.....	61	33.310SS.....	5	33.396.....	12	33.457S-6.....	13
31.021S.....	48	32.409X.....	61	33.310SS-316.....	5	33.398.....	11	33.457ST.....	13
31.022S.....	48	32.512.....	58	33.310SS-316EPDM.....	5	33.398X.....	12	33.458A.....	14

33.458X.....	14	33.536.....	19	34.62713S.....	79	35.2010KL.....	65	35.6010.....	64
33.459A.....	15	33.537.....	19	34.636.....	78	35.2012.....	64	35.6040.....	64
33.459B.....	15	33.538.....	19	34.637.....	78	35.2012K.....	65	35.8020K.....	65
33.459P.....	15	33.539.....	19	34.641.....	77	35.2015.....	64	36.0505.....	66
33.459XA.....	15	33.540.....	19	34.643.....	77	35.2015K.....	65	36.0806.....	66
33.459XB.....	15	33.541.....	19	34.644.....	77	35.2018.....	64	36.1005.....	66
33.460-2C.....	16	33.542.....	21	34.677.....	79	35.2020.....	64	36.1005G.....	66
33.460-2F.....	15	33.543.....	21	34.678.....	79	35.2020K.....	65	36.1005X.....	66
33.460-2X.....	16	33.544.....	21	34.7102-50.....	77	35.2207K.....	65	36.1006SIH.....	67
33.460-4C.....	16	33.545.....	21	34.7196.....	77	35.2502.....	64	36.1007.....	66
33.460-4X.....	16	33.546.....	21	34.7199.....	77	35.2505.....	64	36.1007X.....	66
33.460-6A.....	16	33.547.....	21	34.7514.....	78	35.2505K.....	65	36.1008.....	66
33.460-6C.....	16	33.548.....	21	34.7528-2.....	35	35.2506.....	64	36.1010.....	66
33.460-6K.....	16	33.550.....	20	35.0806.....	64	35.2508K.....	65	36.1010CR.....	66
33.460-6XL.....	16	33.551.....	21	35.0806K.....	65	35.2510.....	64	36.1010E.....	65
33.460-6XLPOM.....	24	33.552.....	20	35.0808K.....	65	35.2510K.....	65	36.1010SIH.....	67
33.462.....	17	33.553.....	20	35.10020K.....	65	35.2515.....	64	36.1010X.....	66
33.462R.....	17	33.554.....	20	35.1003.....	64	35.2515K.....	65	36.1025E.....	63
33.463.....	11	33.555.....	20	35.1003K.....	65	35.2520.....	64	36.102E.....	63
33.464.....	14	33.556.....	20	35.1004.....	64	35.2520K.....	65	36.1035E.....	63
33.465A.....	15	33.611.....	108	35.1004K.....	65	35.2525.....	64	36.103CR.....	63
33.465B.....	15	33.615.....	108	35.1005.....	64	35.2525K.....	65	36.103E.....	63
33.465C.....	15	33.624.....	109	35.1005K.....	65	35.2806K.....	65	36.1045E.....	63
33.465X.....	15	33.625.....	109	35.1007.....	64	35.3003K.....	65	36.104CR.....	63
33.466.....	14	33.670.....	108	35.1007K.....	65	35.3005.....	64	36.105CR.....	63
33.468B.....	8	33.671.....	108	35.1008.....	64	35.3005K.....	65	36.105E.....	63
33.468F.....	8	33.672.....	108	35.1008K.....	65	35.3006K.....	65	36.106CR.....	63
33.468FX.....	8	33.673.....	108	35.1010.....	64	35.3007.....	64	36.106E.....	63
33.468X.....	8	33.674.....	109	35.1010K.....	65	35.3007K.....	65	36.106EG.....	63
33.469X.....	8	33.675.....	109	35.1203.....	64	35.3010.....	64	36.106ESP.....	63
33.470.....	13	33.676.....	109	35.1203K.....	65	35.3010K.....	65	36.107CR.....	63
33.471.....	16	33.848.....	22	35.1204K.....	65	35.3012.....	64	36.107E.....	63
33.472.....	16	33.9779.....	11	35.1204KL.....	65	35.3012K.....	65	36.108CR.....	63
33.473.....	17	34.018X.....	48	35.1206K.....	65	35.3015.....	64	36.108E.....	63
33.474.....	16	34.031X.....	48	35.1208K.....	65	35.3015K.....	65	36.108EG.....	63
33.475.....	15	34.035.....	49	35.1209.....	64	35.3020.....	64	36.109E.....	63
33.478.....	14	34.117/6.....	51	35.1209K.....	65	35.3020K.....	65	36.110CR.....	63
33.479.....	15	34.14334X.....	48	35.1212.....	64	35.3025.....	64	36.110E.....	63
33.480.....	12	34.3011.....	78	35.1212K.....	65	35.3025K.....	65	36.111E.....	63
33.481.....	9	34.3020.....	78	35.1503.....	64	35.3030.....	64	36.112CR.....	63
33.481A.....	9	34.3032.....	77	35.1503K.....	65	35.3030K.....	65	36.112E.....	63
33.481B.....	9	34.601.....	77	35.1504K.....	65	35.3505.....	64	36.112EG.....	63
33.482.....	15	34.601G.....	77	35.1505K.....	65	35.3505K.....	65	36.115CR.....	63
33.483.....	15	34.602.....	77	35.1506K.....	65	35.3510.....	64	36.117E.....	63
33.506.....	12	34.602G.....	77	35.1507.....	64	35.3510K.....	65	36.118CR.....	63
33.510.....	19	34.603.....	77	35.1507K.....	65	35.3535.....	64	36.118E.....	63
33.511.....	20	34.603G.....	77	35.1510.....	64	35.3535K.....	65	36.119CR.....	63
33.512.....	20	34.604.....	77	35.1510K.....	65	35.4003K.....	65	36.1204SIHKF.....	67
33.513.....	20	34.606.....	79	35.1512.....	64	35.4005.....	64	36.1205.....	66
33.514.....	20	34.606X.....	79	35.1512K.....	65	35.4005K.....	65	36.1206.....	66
33.515.....	20	34.607.....	79	35.1515.....	64	35.4010.....	64	36.120CR.....	63
33.516.....	21	34.607X.....	79	35.1515K.....	65	35.4010K.....	65	36.120E.....	63
33.517.....	21	34.608X.....	79	35.1605.....	64	35.4012K.....	65	36.1210.....	66
33.518.....	21	34.609X.....	79	35.1605K.....	65	35.4020.....	64	36.1210E.....	65
33.519.....	21	34.613.....	77	35.1608.....	64	35.4020K.....	65	36.1210X.....	66
33.520.....	21	34.614.....	77	35.1608K.....	65	35.4030.....	64	36.1212SIH.....	67
33.521.....	21	34.620010.....	77	35.1708K.....	65	35.4030K.....	65	36.1212X.....	66
33.523.....	21	34.620040.....	77	35.1803K.....	65	35.4035.....	64	36.122CR.....	63
33.524.....	21	34.620140.....	78	35.18053K.....	65	35.4035K.....	65	36.122E.....	63
33.525.....	22	34.620210.....	77	35.1809K.....	65	35.4040.....	64	36.12511X.....	66
33.526.....	20	34.62039.....	78	35.1904K.....	65	35.4040K.....	65	36.125E.....	63
33.527.....	19	34.62040.....	78	35.2003.....	64	35.4505.....	64	36.130EX.....	63
33.528.....	20	34.62041.....	78	35.2003K.....	65	35.4505K.....	65	36.135E.....	63
33.529.....	19	34.620420.....	78	35.2005.....	64	35.5005.....	64	36.14044.....	70
33.530.....	19	34.62110.....	78	35.20055.....	64	35.5006.....	64	36.1406X.....	66
33.531.....	19	34.624.....	78	35.20055K.....	65	35.5006K.....	65	36.1503.....	66
33.532.....	19	34.625.....	78	35.2005K.....	65	35.5010.....	64	36.1503E.....	65
33.533.....	20	34.626.....	78	35.2006K.....	65	35.5010K.....	65	36.1505E.....	65
33.534.....	19	34.62610S.....	78	35.2010.....	64	35.5020K.....	65	36.1505SIH.....	67
33.535.....	20	34.62713H.....	78	35.2010K.....	65	35.6002K.....	65	36.1505SIHF.....	67

36.1505X.....	66	36.3005.....	66	36.60503.....	75	36.65007CR.....	75	36.9088S.....	70
36.1507X.....	66	36.3005SIHK.....	67	36.60503CR.....	66	36.65010.....	75	36.92117.....	71
36.1510.....	66	36.3005SIHKF.....	67	36.60505.....	75	36.66002.....	75	36.B380.....	69
36.1510E.....	65	36.3005X.....	66	36.60605.....	75	36.66004.....	75	36.K608.....	68
36.1512.....	66	36.3006X.....	66	36.60802.....	75	36.66004X.....	75	36.K613.....	68
36.1512E.....	65	36.3010.....	66	36.60802CR.....	75	36.67502.....	75	36.K616.....	68
36.1512SIH.....	67	36.3010E.....	65	36.60803.....	75	36.68005CR.....	75	36.K671.....	68
36.1515.....	66	36.3010SIH.....	67	36.60804.....	75	36.68005CR-5952.....	75	36.K675.....	68
36.1515SIH.....	67	36.3015.....	66	36.60804CR.....	75	36.7003.....	63	36.K676.....	68
36.1604.....	66	36.3015CR.....	66	36.60805.....	75	36.7004.....	63	36.K677.....	68
36.1605.....	66	36.3015X.....	66	36.60808.....	75	36.7004.5X.....	63	36.K678.....	68
36.1610SIH.....	67	36.3020.....	66	36.60808CR.....	75	36.7005.....	63	36.K679.....	69
36.1612E.....	65	36.3020SIH.....	67	36.61001.....	75	36.7005X.....	63	36.K680.....	69
36.1612X.....	66	36.3020X.....	66	36.61002.....	75	36.7006.....	63	36.K681.....	69
36.1616SIHF.....	67	36.3025E.....	65	36.61003.....	75	36.7006X.....	63	36.K683.....	69
36.1808G.....	66	36.3030.....	66	36.61003CR.....	75	36.7007X.....	63	36.K695.....	69
36.1815EG.....	65	36.3305X.....	66	36.61004.....	75	36.7008.....	63	36.K697.....	69
36.1816.....	66	36.3314.....	64	36.61005.....	75	36.7008.5X.....	63	36.K698.....	69
36.197.....	64	36.3315.....	69	36.61008.....	75	36.7008X.....	63	36.K852.....	69
36.198.....	64	36.3351.....	69	36.61010.....	75	36.7009.....	63	36.K853.....	69
36.198A.....	64	36.3354.....	69	36.61010CR.....	75	36.7009X.....	63	37.250.....	123
36.198CR.....	64	36.34155105.....	64	36.61203.....	75	36.7010.....	63	37.251.....	123
36.198S.....	64	36.3416068.....	64	36.61204.....	75	36.7010.5X.....	63	37.260.....	129
36.199.....	64	36.341840.....	64	36.61205.....	75	36.7010X.....	63	37.261.....	129
36.200.....	64	36.342026.....	64	36.61310.....	75	36.7011.5X.....	63	37.262.....	129
36.2002.....	66	36.342030.....	64	36.61502.....	75	36.7011X.....	63	37.263.....	129
36.2003.....	66	36.342226.....	64	36.61503.....	75	36.7012.....	63	37.400.....	129
36.2003SIH.....	67	36.342232.....	64	36.61505.....	75	36.7012X.....	63	38.1215.....	131
36.2005.....	66	36.342433.....	64	36.61506.....	75	36.7014X.....	63	38.1215N.....	131
36.2005CR.....	75	36.342529.....	64	36.61508.....	75	36.7015.....	63	38.14572.....	130
36.2005SIH.....	67	36.342840.....	64	36.61510.....	75	36.7018X.....	63	38.14574.....	130
36.2005SIHF.....	67	36.344511.....	64	36.61512.....	75	36.7028X.....	63	38.14574/3.....	130
36.2005SIHK.....	67	36.3504.....	69	36.61518.....	75	36.7050.....	63	38.152EPDM.....	68
36.2005X.....	66	36.3515X.....	66	36.61530.....	75	36.7064X.....	63	38.153EPDM.....	68
36.2008X.....	66	36.3516.....	66	36.61603.....	75	36.720802.....	73	38.154EPDM.....	68
36.2010.....	66	36.3520E.....	65	36.61609CR.....	75	36.720803.....	73	38.155EPDM.....	68
36.2010CR.....	66	36.3520X.....	66	36.61710.....	75	36.720903.....	73	38.156EPDM.....	68
36.2010E.....	65	36.3704.....	70	36.61808.....	75	36.720904.....	73	38.158EPDM.....	68
36.2010SIH.....	67	36.3813.....	69	36.62002.....	75	36.721004.....	73	38.160E/K.....	75
36.2010SIHK.....	67	36.3881.....	69	36.62002CR.....	75	36.721004-6.....	73	38.160EPDM.....	68
36.2010X.....	66	36.3881S.....	69	36.62003.....	75	36.721005.....	73	38.162EPDM.....	68
36.2015SIH.....	67	36.3882.....	70	36.62004.....	75	36.721006.....	73	38.165EPDM.....	68
36.2020.....	66	36.3897.....	70	36.62004CR.....	75	36.721202.....	73	38.170E/K.....	75
36.2020CR.....	66	36.4005SIHK.....	67	36.62005.....	75	36.721203.....	73	38.170EPDM.....	68
36.2020SIH.....	67	36.4010.....	66	36.62008.....	75	36.7213564.....	73	38.175E/K.....	75
36.2020SIHF.....	67	36.4010E.....	65	36.62010.....	75	36.721503.....	73	38.175EPDM.....	68
36.208.....	64	36.4010X.....	66	36.62020.....	75	36.721504.....	73	38.180NR.....	68
36.2318X.....	66	36.4012.....	66	36.62305.....	75	36.721508.....	73	38.188.....	75
36.2502CR.....	75	36.4012SIH.....	67	36.62502.....	75	36.721508B.....	73	38.189.....	75
36.2503.....	66	36.4015.....	66	36.62505CR.....	75	36.722004.....	73	38.190.....	75
36.2505.....	66	36.4015E.....	65	36.62506.....	75	36.730805H.....	70	38.191.....	75
36.2505SIH.....	67	36.4020CR.....	66	36.62510.....	75	36.730808.....	70	38.201.5.....	131
36.2505SIHF.....	67	36.4020E.....	65	36.62525.....	75	36.730810.....	70	38.202.....	131
36.2505X.....	66	36.4020X.....	66	36.63005.....	75	36.730906.....	70	38.203.....	131
36.2507X.....	66	36.4025.....	66	36.63005CR-5952.....	75	36.730906H.....	70	38.205.....	131
36.2508X.....	66	36.4025E.....	65	36.63010.....	75	36.730907.....	70	38.27700002.....	75
36.2510.....	66	36.4030E.....	65	36.63012.....	75	36.730907G.....	70	38.27700003.....	75
36.2510E.....	65	36.5005CR.....	66	36.63030CR.....	75	36.730907H.....	70	38.27700004.....	75
36.2510SIH.....	67	36.5005SIH.....	67	36.63204CR.....	75	36.730955.....	71	38.27700005.....	75
36.2512X.....	66	36.5005X.....	66	36.64003.....	75	36.730955B.....	71	38.27700006.....	75
36.2515.....	66	36.5010.....	66	36.64004CR.....	66	36.730955G.....	71	38.27700008.....	75
36.2515SIH.....	67	36.5010E.....	65	36.64004CR.....	75	36.730955H.....	71	38.27700010.....	75
36.2520.....	66	36.5010X.....	66	36.64005.....	75	36.731210.....	71	38.27700015.....	75
36.2520E.....	65	36.5020.....	66	36.64005CR.....	75	36.731210H.....	71	38.27700020.....	75
36.2520SIH.....	67	36.5020E.....	65	36.64010.....	75	36.731412D.....	71	38.27700025.....	75
36.2525.....	66	36.5025.....	66	36.64015.....	75	36.732115.....	71	38.345522.....	128
36.2525E.....	65	36.5030.....	66	36.64020.....	75	36.740907H.....	71	38.401-3.....	115
36.2525SIH.....	67	36.6030E.....	65	36.65003.....	75	36.80955S.....	71	38.400-10.....	115
36.3003.....	66	36.60403.....	75	36.65005CR.....	75	36.90810.....	70	38.400-12.....	115
36.3003X.....	66	36.60404.....	75	36.65005CR-5952.....	75	36.9086S.....	70	38.400-15.....	115

38.400-2	115	38.425N-3	122	39.171J	85	39.4224	102	39.680H	101
38.400-20	115	38.425N-5	122	39.172	86	39.4229	102	39.680H-1180	101
38.400-25	115	38.426-3	122	39.173	86	39.4244	102	39.680X	101
38.400-3	115	38.426-3C	122	39.174	85	39.4249	102	39.684X	101
38.400-4	115	38.426-3CX	122	39.175H	85	39.4250	102	39.684XS	101
38.400-5	115	38.426-3XL	122	39.175J	85	39.4251	102	39.685	101
38.400-6	115	38.426-5	122	39.177	85	39.4257	102	39.69	102
38.400-6/650	115	38.426-5C	122	39.178	85	39.4269	102	39.79	102
38.400-8	115	38.426-5CX	122	39.179	85	39.4310	102	39.93	102
38.401-10	115	38.426-8C	122	39.180	89	39.4311	102	39.AV2024	98
38.401-15	115	38.427-3CXL	118	39.181	89	39.4333	101	39.AV30	98
38.401-2	115	38.427-3GC	118	39.181052	86	39.4380	102	39.AV5068	98
38.401-20	115	38.429-2	117	39.181060	86	39.4380X	101	39.AV9580	98
38.401-4	115	38.430-10/70	130	39.181061	86	39.4381	102	39.B08/08-43	93
38.401-5	115	38.430-10/90	130	39.182	89	39.4399	101	39.B10/10	93
38.401-6	115	38.430-5/70	130	39.183	89	39.4403	102	39.B100/30	93
38.402-0.5	116	38.430-5/80	130	39.183A	89	39.55	102	39.B100/40	93
38.402-1	116	38.430-8/70	130	39.183B	89	39.56	102	39.B100/50	93
38.402-2	116	38.430-8/90	130	39.183C	89	39.57	102	39.B100/75	93
38.402-3	116	38.431	122	39.184	89	39.620J	86	39.B100/75-55	93
38.402-4	116	38.431-3	122	39.185	89	39.623J	86	39.B15/10	93
38.402-5	116	38.431-3C	122	39.186	89	39.624	86	39.B15/15	93
38.403-2	116	38.431-5	122	39.187	89	39.625	86	39.B15/15-M4x8	93
38.403-3	116	38.431-5C	122	39.188	89	39.626J	86	39.B15/15-M5x10	93
38.403-4	116	38.432	118	39.20/15-M5	95	39.627	86	39.B15/15-R11	93
38.403-5	116	38.433	118	39.20/8-M8	95	39.628	86	39.B16/18	93
38.403-6	116	38.434	120	39.2486	101	39.629	87	39.B20/10	93
38.403-8	116	38.434A	120	39.2776	102	39.630	87	39.B20/10-M6	93
38.404-10	116	38.435C	120	39.30/17	97	39.631A	87	39.B20/15	93
38.404-12	116	38.436C	121	39.3010	101	39.631X	87	39.B20/15-A4	93
38.404-15	116	38.440-6	129	39.3023	102	39.632A	85	39.B20/15-M6	93
38.404-2	116	38.440-6A	129	39.3029	102	39.632B	85	39.B20/15-M6-43	93
38.404-20	116	38.440-6B	129	39.3051	102	39.632C	85	39.B20/20-M6-43	93
38.404-3	116	38.440-8	129	39.3240	101	39.632J	85	39.B20/20-M6x15-43	93
38.404-4	116	38.440-8A	129	39.3366	102	39.634	87	39.B20/20-M6	93
38.404-5	116	38.440-8X	129	39.3381	102	39.634P	87	39.B20/25-M6	93
38.404-6	116	38.449-1200	130	39.3428	102	39.635	88	39.B2020	93
38.404-8	116	38.449-1600	130	39.3581	102	39.635X	88	39.B25/25	93
38.405-10	117	38.449-750	130	39.360	86	39.636	88	39.B25/25-M6	93
38.405-10X	117	38.450-760	130	39.36412	102	39.636X	88	39.B25/30	93
38.405-15	117	38.451-1600	130	39.3700	102	39.637	86	39.B2513	93
38.405-20	117	38.452-1200	130	39.3722	101	39.638	86	39.B30/20	93
38.405-40	117	38.5017530	126	39.3726	102	39.642	87	39.B30/20-M6x10-43	93
38.405-6	117	38.5017530A	126	39.3802	102	39.642X	87	39.B30/20-M6x10-57	93
38.405-8	117	38.5501110	128	39.3803	102	39.643X	87	39.B30/20XXX	93
38.406-2T	117	38.5501210	128	39.3803X	101	39.644	87	39.B30/20NBR	93
38.406-3H	117	38.5501310	128	39.3813	102	39.644A	87	39.B30/20X	93
38.406-3T	117	38.623750	128	39.3815	102	39.645	90	39.B30/20XX	93
38.406-5T	117	38.623752	128	39.3846	101	39.646	86	39.B30/25-43	93
38.407-3	119	38.623764	128	39.3849	102	39.647	87	39.B30/30-M6	93
38.407-3C	119	38.8100110	125	39.3868	101	39.648	87	39.B30/30-M6-M8x23	93
38.407-3G	119	38.8100310	125	39.3872	101	39.649	87	39.B3030	93
38.407-3X	119	38.8103110	125	39.3873	101	39.650	87	39.B30/40	93
38.407-3XL	119	38.9110030	127	39.3874	101	39.651	87	39.B40/20	93
38.410200	126	38.9117630	127	39.3875	101	39.651A	87	39.B40/30-M8x10-43	93
38.410201	126	38.9117631	127	39.3876	101	39.652	87	39.B40/30	93
38.418	119	38.9716230	127	39.3878	102	39.653	87	39.B40/35	93
38.418N	119	38.9726230	125	39.3879	102	39.656	88	39.B50/20-M8	93
38.419A	121	38.9730030	125	39.3887	101	39.657	88	39.B50/25	93
38.419C	120	38.9730030S	125	39.3904X	101	39.658	88	39.B50/30	93
38.420CX	121	38.9750030	125	39.3923	102	39.659	88	39.B50/40	93
38.420X	121	38.9971010	130	39.3925	102	39.660	88	39.B50/40-43	93
38.420XL	121	38.9971020	130	39.3952	102	39.661	88	39.B50/50	93
38.422-1750	129	39.103195	99	39.4012	102	39.662	88	39.B50/50-M10	93
38.423-1750	129	39.1208P	30	39.4054	102	39.663	88	39.B60/30	93
38.424-1800	129	39.167G	85	39.4087	101	39.664	88	39.B60/40	93
38.425-3	122	39.168G	85	39.4110	102	39.665	88	39.B60/45-A2	93
38.425-3C	122	39.169G	85	39.4129	102	39.674	101	39.B75/30	93
38.425-5	122	39.170G	85	39.4156	101	39.678	101	39.B75/40	93
38.425-5C	122	39.171G	85	39.4178	101	39.678X	101	39.B75/40-M10x18	93

39.B75/40-M12x40.....	93	39.D10/10-A2.....	95	39.D50/30-M10.....	96	39.E60/30.....	97	39.M20/15-A4.....	92
39.B75/40-M8x18X.....	93	39.D100/30.....	96	39.D50/30-M10-A2.....	96	39.E60/30-M12.....	97	39.M20/20-A2.....	92
39.B75/50.....	93	39.D100/50.....	96	39.D50/30-M10x38.....	96	39.E60/40.....	97	39.M20/8-M6.....	92
39.BUMPER.....	137	39.D100/75.....	96	39.D50/40.....	96	39.E60/40-M12.....	97	39.M2015.....	92
39.BUMPER-CAR.....	105	39.D13/13-M8x35.....	95	39.D50/40-43.....	96	39.E70/35.....	97	39.M2020.....	92
39.BUMPERB.....	137	39.D15/10.....	95	39.D50/40NBR.....	96	39.E70/50.....	97	39.M2020-M6-45.....	92
39.BUMPERC.....	137	39.D15/10-M6.....	95	39.D50/50.....	96	39.E75/30.....	97	39.M2020-M8.....	92
39.BUMPERD.....	137	39.D15/15.....	95	39.D50/60.....	96	39.E75/30-M12.....	97	39.M24.....	90
39.BUMPERE.....	137	39.D15/15-M6.....	95	39.D50/80.....	96	39.E75/45-M12.....	97	39.M25/10-M6ESD.....	92
39.C100/40.....	94	39.D15/4G-M4x6.....	95	39.D60/30.....	96	39.E75/50.....	97	39.M25/10-M8.....	92
39.C100/50.....	94	39.D150/50.....	96	39.D60/30-M12.....	96	39.E75/50-M12.....	97	39.M25/10-M8x10/20.....	92
39.C100/55NBR68.....	94	39.D20/10.....	95	39.D60/40.....	96	39.E80/50.....	97	39.M2515.....	92
39.C100/60-M12.....	94	39.D20/10-A4.....	95	39.D60/40M12.....	96	39.E80/50-M16.....	97	39.M25/22.....	92
39.C100/75.....	94	39.D20/15E.....	95	39.D60/50.....	96	39.GMF100/42.....	98	39.M2515-55.....	92
39.C150/40.....	94	39.D20/20.....	95	39.D65/35.....	96	39.GMF108/46.....	98	39.M2520.....	92
39.C150/75-M20.....	94	39.D20/20-M6.....	95	39.D70/40.....	96	39.GMF122/50.....	98	39.M2520-M6.....	92
39.C20/10.....	94	39.D20/20-M6x43.....	95	39.D70/40-M12.....	96	39.GMF150/54.....	98	39.M30/10.....	92
39.C20/15.....	94	39.D25/15.....	95	39.D70/45-M10x12.....	96	39.GMF67/34.....	98	39.M30/20XX.....	92
39.C20/20.....	94	39.D25/15-A2.....	95	39.D75/40-68.....	96	39.GMF67/34-SH.40.....	98	39.M3015.....	92
39.C20/20-A4.....	94	39.D25/18.....	95	39.D75/50-M10.....	96	39.GMF75/34.....	98	39.M3015-M8x15.....	92
39.C20/25-VMQ.....	94	39.D30/10.....	95	39.D75/50-M10/sh68.....	96	39.KD25/17.....	98	39.M3020.....	92
39.C200/100.....	94	39.D30/10-A2.....	95	39.D75/50-M12.....	96	39.KD50/18.....	98	39.M3020-55.....	92
39.C25/10.....	94	39.D30/10-M6.....	95	39.D8/5.....	95	39.KP-D10/10.....	98	39.M3030.....	92
39.C25/15.....	94	39.D30/10-M6x15.....	95	39.DC300300.....	104	39.KP-D115/136.....	98	39.M3030-SS.....	92
39.C25/15-A2.....	94	39.D30/10-M6x28.....	95	39.DD150150.....	103	39.KP-D118/77.....	98	39.M40/20.....	92
39.C25/25.....	94	39.D30/12-M6G.....	95	39.DD300300.....	103	39.KP-D15/22.....	98	39.M40/38-M12.....	92
39.C25/25-M8.....	94	39.D30/15.....	95	39.DD350350.....	103	39.KP-D20/15.....	98	39.M40/40.....	92
39.C30/15.....	94	39.D30/15-M10x25.....	95	39.E100/25.....	97	39.KP-D25/16.....	98	39.M40/40-A2.....	92
39.C30/20.....	94	39.D30/15-M10x50.....	95	39.E100/30.....	97	39.KP-D25/20.....	98	39.M40/50-A2.....	92
39.C30/22.....	94	39.D30/15-M6.....	95	39.E100/40.....	97	39.KP-D30/30.....	98	39.M4025.....	92
39.C30/30.....	94	39.D30/15-M6G.....	95	39.E100/40NBR.....	97	39.KP-D30/36.....	98	39.M4030.....	92
39.C30/30-A4.....	94	39.D30/15-M8x23.....	95	39.E100/40NBR43.....	97	39.KP-D30/36-A2.....	98	39.M4038.....	92
39.C30/40.....	94	39.D30/18-M10.....	95	39.E100/40NBR68.....	97	39.KP-D30/36-A4.....	98	39.M50/20-M10X.....	92
39.C40/20.....	94	39.D30/20.....	95	39.E100/50.....	97	39.KP-D50/50.....	98	39.M50/20NBR.....	92
39.C40/25.....	94	39.D30/20-M6.....	95	39.E100/55NBR68.....	97	39.KP-D50/58.....	98	39.M50/30-A2.....	92
39.C40/30.....	94	39.D30/20-M6-43.....	95	39.E100/75.....	97	39.KP-D50/61.....	98	39.M50/30NBR.....	92
39.C40/40.....	94	39.D30/20-M8x15.....	95	39.E150/50.....	97	39.KP-D50/67.....	98	39.M5025.....	92
39.C40/40-M10.....	94	39.D30/30.....	95	39.E150/50-M20.....	97	39.KP-D60/40.....	98	39.M5030.....	92
39.C40/50.....	94	39.D30/30-M6.....	95	39.E150/75-M20.....	97	39.KP-D70/58.....	98	39.M5040.....	92
39.C40/50-68.....	94	39.D30/8-M6G.....	95	39.E20/10.....	97	39.KP-D70/60.....	98	39.M5045.....	92
39.C50/20.....	94	39.D30/8-M6GX.....	95	39.E20/10-M6.....	97	39.KP-D75/89.....	98	39.M5050.....	92
39.C50/25.....	94	39.D30/8-M6x18.....	95	39.E20/25-68.....	97	39.KP-D75/89-10.....	98	39.M60/50.....	93
39.C50/30.....	94	39.D30/8-M6x23.....	95	39.E25/10.....	97	39.KP-E10/10.....	98	39.M6035.....	92
39.C50/30-68.....	94	39.D40/15.....	95	39.E25/10-M6.....	97	39.KP-E115/136.....	98	39.M6050.....	92
39.C50/30-A2.....	94	39.D40/15-M6.....	95	39.E25/25.....	97	39.KP-E118/77.....	98	39.M7540.....	92
39.C50/30-M8.....	94	39.D40/20.....	95	39.E25/25-68.....	97	39.KP-E15/22.....	98	39.M7550.....	92
39.C50/35.....	94	39.D40/20-A2.....	95	39.E30/10-M6-43.....	97	39.KP-E20/15.....	98	39.M7560.....	92
39.C50/35-43.....	94	39.D40/20-M10.....	95	39.E30/10-M6G.....	97	39.KP-E20/24.....	98	39.M8050.....	92
39.C50/40.....	94	39.D40/20-M6.....	95	39.E30/15.....	97	39.KP-E25/16.....	98	39.M9/12-43.....	92
39.C50/40-M12.....	94	39.D40/20-M6-43.....	95	39.E30/15-M6.....	97	39.KP-E25/20.....	98	39.SC300300.....	104
39.C50/45.....	94	39.D40/25-A2.....	95	39.E30/15-M6G.....	97	39.KP-E30/30.....	98	39.SD300250.....	103
39.C50/50.....	94	39.D40/25-A2-S.....	95	39.E30/20.....	97	39.KP-E30/36.....	98	39.SD300300.....	103
39.C60/30.....	94	39.D40/30.....	96	39.E30/20-M6.....	97	39.KP-E35/40.....	98	41.13459.....	36
39.C60/30-M8.....	94	39.D40/30-A2.....	96	39.E30/25.....	97	39.KP-E50/50.....	98	41.13459X.....	36
39.C60/40.....	94	39.D40/30-M8.....	96	39.E30/30.....	97	39.KP-E50/61.....	98	41.333S.....	30
39.C60/40-M10.....	94	39.D40/30-M8x23.....	96	39.E30/30-M6.....	97	39.KP-E50/67.....	98	41.406.....	37
39.C60/40-M12.....	94	39.D40/35.....	96	39.E30/35.....	97	39.KP-E50/68.....	98	41.670.....	36
39.C60/45.....	94	39.D40/35-A2.....	96	39.E40/15-SH.43.....	97	39.KP-E60/40.....	98	41.674A.....	30
39.C65/35.....	94	39.D40/35-M8-A2.....	96	39.E40/20.....	97	39.KP-E70/58.....	98	41.675A.....	30
39.C65/35-M10.....	94	39.D40/38.....	96	39.E40/20-M6.....	97	39.KP-E70/60.....	98	41.678.....	31
39.C70/45-M10.....	94	39.D40/40-A2.....	96	39.E40/20NBR.....	97	39.KP-E75/89.....	98	45.102G.....	82
39.C70/50-A2.....	94	39.D40/40-M8x23-68.....	96	39.E40/30.....	97	39.KP-E75/89-M10.....	98	45.123.....	82
39.C75/30.....	94	39.D40/40.....	96	39.E40/30-M6.....	97	39.KP-E95/80.....	98	45.2031024.....	82
39.C75/30-M10.....	94	39.D40/45-A2.....	96	39.E50/20.....	97	39.M10/10.....	92	45.20511046.....	82
39.C75/30-M10-68.....	94	39.D50/20.....	96	39.E50/20-M10.....	97	39.M100/50NBR.....	92	45.20511091.....	82
39.C75/50.....	94	39.D50/20-M10x15.....	96	39.E50/20-M12.....	97	39.M100/55-40.....	92	45.2051445.....	83
39.C75/55.....	94	39.D50/20-M12.....	96	39.E50/25.....	97	39.M15/15.....	92	45.205SX.....	37
39.C75/55-43A.....	94	39.D50/25.....	96	39.E50/25-M12.....	97	39.M1810.....	92	45.206AL.....	81
39.C75/55-M10.....	94	39.D50/25-M12.....	96	39.E50/40.....	97	39.M20/10.....	92	45.208.....	37
39.D10/10.....	95	39.D50/30.....	96	39.E50/40-M12.....	97	39.M20/10-M6.....	92	45.209BX.....	37

45.210BX.....	37	48.636KF.....	111	50.271.....	134	79.054A.....	135	Group0131.....	40
45.210C.....	37	50.083000GG.....	46	50.275.....	134	79.055.....	135	Group0132.....	40
45.210CX.....	37	50.083000SS.....	46	50.276.....	134	79.056.....	135	Group0133.....	40
45.216C-50.....	82	50.083013.....	44	50.280.....	135	83.842.....	144	Group0134.....	40
45.217C.....	81	50.083015GG.....	44	52.269X.....	55	84.930.....	144	Group0135.....	42
45.221C.....	81	50.083015GGX.....	44	52.CWC8.....	90	84.931.....	144	Group0136.....	42
45.224.....	81	50.083030.....	44	52.PP106.....	36	84.932T.....	144	Group0137.....	40
45.235N1057.....	83	50.083032GG.....	44	52.PPCC720.....	137	84.934.....	144	Group0138.....	41
45.235N429.....	83	50.083033.....	44	52.PPTLRED.....	137	84.934A.....	144	Group0139.....	39
45.235NG1057.....	83	50.083040.....	44	54.261100.....	139	84.935.....	144	Group0140.....	40
45.235NG429.....	83	50.083040G.....	44	54.261120.....	139	87.1034.....	145	Group0141.....	40
45.308C.....	82	50.083040GG.....	44	54.261130.....	139	87.1035.....	145	Group0142.....	41
45.308C-50.....	82	50.083040GS.....	44	54.261700J-5.....	139	87.2010.....	145	Group0143.....	41
45.309C.....	82	50.083045G.....	44	54.261720J-5.....	139	87.51939S.....	145	Group0144.....	40
45.309C-50.....	82	50.083045X.....	44	54.261740J-5.....	139	87.51989.....	145	Group0145.....	40
45.347C.....	81	50.083046.....	44	54.261760J-5.....	139	87.51999F.....	145	Group0146.....	40
45.383C.....	81	50.083050.....	44	54.261780J-5.....	139	87.52759.....	145	Group0147.....	40
45.388C.....	81	50.083050GG.....	44	54.710720.....	44	87.52759X.....	145	Group0148.....	40
45.393.....	82	50.083052G.....	44	54.710770.....	45	87.705I.....	145	Group0150.....	39
45.394.....	82	50.083055G.....	45	54.710780.....	46	87.723.....	145	Group0151.....	41
45.705C.....	81	50.083059.....	45	56.7001-007.....	85	87.770/10.....	145	Group0152.....	41
45.832.....	81	50.083060.....	45	57.400/3E.....	107	87.81152.....	145	Group0153.....	39
45.836.....	81	50.083060G.....	45	57.401/3E.....	107	87.812015.....	145	Group0154.....	41
45.837.....	81	50.083061.....	45	57.402/3E.....	107	87.81252.....	145	Group0155.....	40
45.839.....	81	50.083065.....	45	57.403/2.5J.....	108	87.81302.....	145	Group0156.....	41
45.872.....	81	50.083065G.....	45	57.403/3E.....	107	87.814015.....	145	Group0157.....	41
45.874.....	81	50.083070B.....	45	57.404/3E.....	107	DC-fender.....	104	Group0158.....	40
45.882.....	81	50.083070G.....	45	57.405/2J.....	108	DD-fender.....	103	Group0159.....	39
45.884C.....	81	50.083070GG.....	45	57.405/3E.....	107	Group0010.....	39	Group0160.....	39
45.886.....	82	50.083080G.....	45	57.406/3E.....	107	Group0011.....	39	Group0161.....	42
45.886G.....	82	50.083081.....	45	57.407/3E.....	107	Group0012.....	39	Group0163.....	41
45.894.....	82	50.083088.....	45	57.408/3E.....	107	Group0020.....	39	Group0164.....	41
45.901.....	82	50.083089.....	45	57.410/3E.....	107	Group0021.....	39	Group0165.....	41
45.980A.....	82	50.083090.....	46	57.411/3E.....	107	Group0022.....	39	Group0166.....	41
45.980K.....	82	50.083095B.....	46	57.412/3E.....	107	Group0023.....	39	Group0167.....	40
45.980S.....	82	50.083095BB.....	45	57.413/3E.....	107	Group0024.....	39	Group0168.....	41
48.442.....	113	50.083095G.....	46	57.423/3E.....	107	Group0025.....	39	Group0169.....	39
48.451.....	112	50.13621.....	135	57.424/3E.....	107	Group0030.....	39	Group0170.....	40
48.452.....	112	50.241NR.....	133	57.425/3E.....	107	Group0100.....	39	Group0171.....	40
48.542.....	113	50.242NR.....	133	57.426/3E.....	107	Group0101.....	39	Group0172.....	40
48.544A.....	113	50.243NR.....	134	57.427/3E.....	107	Group0102.....	40	Group0173.....	41
48.603.....	111	50.244NR.....	134	57.428/3E.....	107	Group0102A.....	40	Group0174.....	42
48.605.....	112	50.245H.....	133	57.429/3E.....	107	Group0103.....	40	Group0175.....	39
48.605B.....	112	50.245NR.....	133	57.430/3E.....	107	Group0103A.....	40	Group0176.....	41
48.605X.....	112	50.246-10.....	133	57.431/3E.....	107	Group0104.....	40	Group0177.....	41
48.605Y.....	112	50.246NR.....	133	57.440/3E.....	107	Group0105.....	40	Group0178.....	39
48.608.....	112	50.247NR.....	133	57.441/3E.....	107	Group0106.....	39	Group0179.....	40
48.609.....	112	50.250.....	133	57.442/3E.....	107	Group0107.....	39	Group0180.....	41
48.612.....	113	50.252G.....	133	57.443/2JP.....	108	Group0108.....	39	Group0181.....	40
48.613K.....	111	50.252J.....	133	57.443/3E.....	107	Group0109.....	39	Group0182.....	41
48.618.....	113	50.254J.....	133	57.444/3E.....	107	Group0110.....	39	Group0183.....	41
48.621.....	112	50.255J.....	133	57.445/3E.....	107	Group0111.....	39	Group0184.....	42
48.622.....	112	50.260-10.....	27	57.446/3E.....	107	Group0112.....	39	Group0185.....	42
48.622X.....	112	50.260-10T.....	27	57.447/3E.....	107	Group0113.....	39	Group0186.....	39
48.623.....	112	50.260-4.....	27	57.448/3E.....	107	Group0115.....	41	Group0187.....	41
48.623X.....	112	50.260-5.....	27	57.449/3E.....	107	Group0116.....	41	Group0188.....	40
48.624.....	112	50.260-6.....	27	57.450/3E.....	107	Group0117.....	41	Group0189.....	41
48.626.....	111	50.260-8.....	27	57.451/3E.....	107	Group0118.....	42	Group0190.....	41
48.634.....	111	50.261.....	134	57.452/3E.....	107	Group0119.....	39	Group0191.....	40
48.634F.....	111	50.263.....	134	57.453/3E.....	107	Group0120.....	39	Group0192.....	39
48.634K.....	111	50.263K.....	134	57.454/3E.....	107	Group0121.....	39	Group0193.....	41
48.634KF.....	111	50.263K-10.....	134	57.455/3E.....	107	Group0122.....	41	Group0194.....	40
48.635.....	111	50.263KL.....	134	57.456/3E.....	107	Group0123.....	41	Group0195.....	42
48.635F.....	111	50.264NR.....	134	63.550300.....	113	Group0124.....	39	Group0196.....	41
48.635K.....	111	50.265.....	133	68.4250.....	113	Group0125.....	39	Group0197.....	41
48.635KF.....	111	50.266.....	133	79.051.....	135	Group0126.....	39	Group0198.....	41
48.636.....	111	50.267.....	134	79.051A.....	135	Group0127.....	40	Group0199.....	40
48.636F.....	111	50.267-10.....	134	79.052.....	135	Group0128.....	40	Group0200.....	41
48.636FX.....	111	50.267NR.....	134	79.053.....	135	Group0129.....	40	Group0201.....	39
48.636K.....	111	50.269.....	134	79.054.....	135	Group0130.....	40	Group0202.....	41

Group 0203.....	42
Group 0204.....	42
Group 0205.....	41
Group 0206.....	40
Group 0207.....	40
Group 0208.....	39
Group 0209.....	39
Group 0210.....	41
Group 0211.....	40
Group 0212.....	42
Group 0213.....	41
Group 0214.....	39
Group 0215.....	41
Group 0501.....	42
Group 0502.....	42
Group 0503.....	42
Group 0504.....	42
Group 0505.....	42
Group 0506.....	42
Group 0507.....	42
Group 0508.....	40
Group 0509.....	42
Group 0510.....	41
Group 0511.....	42
Group 0512.....	41
Group 0513.....	42
Group 0514.....	42
Group 0515.....	42
Group 0516.....	40
Group 0517.....	40
Keyhole-fender.....	105
KF-A-fender.....	105
KF-B-fender.....	105
KF-C-fender.....	105
KF-D-fender.....	105
MC-fender.....	105
S10.3301.....	144
S10.3303.....	144
S10.3311.....	144
S10.3312.....	144
S10.3313.....	144
S10.3314.....	144
SC-fender.....	104
SD-fender.....	103
Wing-type-fender.....	105



HEADQUARTERS

EUROPE

- Switzerland
- Austria
- Bosnia
- Bulgaria
- Croatia
- Czech Republic
- Denmark
- France
- Germany
- Hungary
- Italy
- Latvia
- Poland
- Portugal
- Romania
- Serbia
- Slovakia
- Slovenia
- Spain
- The Netherlands
- Turkey
- Ukraine
- United Kingdom

ASIA

- China
- India
- Malaysia
- Thailand
- Vietnam

BIBUS SINDBY A/S

Edisonvej 11
DK-7100 Vejle

Tel. +45 75 88 21 22
Fax +45 75 88 21 21
bibus@bibus.dk
www.bibus-sindby.dk



Tryksag
5041 0826
Scandinavian Print Group